



HUMAN  
RIGHTS  
WATCH

# Delivered Into Enemy Hands

US-Led Abuse and Rendition of Opponents to Gaddafi's Libya



# **Delivered Into Enemy Hands**

**US-Led Abuse and Rendition of Opponents to Gaddafi's Libya**

Copyright © 2012 Human Rights Watch

All rights reserved.

Printed in the United States of America

ISBN: 1-56432-940-2

Cover design by Rafael Jimenez

Human Rights Watch is dedicated to protecting the human rights of people around the world. We stand with victims and activists to prevent discrimination, to uphold political freedom, to protect people from inhumane conduct in wartime, and to bring offenders to justice. We investigate and expose human rights violations and hold abusers accountable. We challenge governments and those who hold power to end abusive practices and respect international human rights law. We enlist the public and the international community to support the cause of human rights for all.

Human Rights Watch is an international organization with staff in more than 40 countries, and offices in Amsterdam, Beirut, Berlin, Brussels, Chicago, Geneva, Goma, Johannesburg, London, Los Angeles, Moscow, Nairobi, New York, Paris, San Francisco, Tokyo, Toronto, Tunis, Washington DC, and Zurich.

For more information, please visit our website: <http://www.hrw.org>



# Delivered Into Enemy Hands

## US-Led Abuse and Rendition of Opponents to Gaddafi’s Libya

<b>Summary .....</b>	<b>1</b>
<b>Key Recommendations.....</b>	<b>13</b>
<b>Methodology .....</b>	<b>15</b>
<b>I. Background .....</b>	<b>18</b>
Libya from the 1970s to the 1990s.....	18
Flight from Libya .....	21
Libyan Islamic Fighting Group .....	23
Gaddafi’s Rapprochement with the West.....	28
<b>II. Detainee Accounts from Afghanistan and Morocco.....</b>	<b>31</b>
Mohammed Ahmed Mohammed al-Shoroeiya and Khalid al-Sharif.....	31
Departure from Libya.....	33
Arrest and Detention .....	34
Afghanistan I.....	38
Afghanistan II.....	53
Shoroeiya’s Transfer and Treatment in Libya.....	56
Sharif’s Transfer and Treatment in Libya .....	58
Majid Mokhtar Sasy al-Maghrebi.....	60
Departure from Libya.....	60
Pakistan.....	61
Afghanistan I.....	62
Afghanistan II.....	65
Transfer and Treatment in Libya.....	66
Saleh Hadiyah Abu Abdullah Di’iki.....	67
Departure from Libya.....	67
Arrest and Detention .....	68
Afghanistan I.....	70
Afghanistan II.....	72
Transfer and Treatment in Libya.....	75
Mustafa Salim Ali el-Madaghi .....	78
Morocco.....	79
Transfer and Treatment in Libya.....	80



Mustafa Jawda al-Mehdi .....	83
Departure from Libya.....	83
Arrest and Detention .....	84
Peshawar .....	84
Islamabad.....	85
Afghanistan .....	85
Transfer and Treatment in Libya.....	88
<b>III. Transfers to Libya that Began in Asia .....</b>	<b>91</b>
Abdul Hakim Belhadj.....	91
Departure from Libya.....	92
Malaysia and Thailand .....	93
Treatment in Libya.....	99
Sami Mostefa al-Saadi .....	102
Departure from Libya.....	102
Treatment in Libya.....	107
Muhammed Abu Farsan .....	111
Departure from Libya.....	111
Treatment in Libya.....	115
<b>IV. Transfer from Guantanamo Bay: The Case of Abdusalam Abdulhadi Omar as-Safrani .....</b>	<b>117</b>
Departure from Libya.....	117
Transfer to Guantanamo .....	118
Transfer and Treatment in Libya.....	119
<b>V. The Case of Ibn al-Sheikh al-Libi .....</b>	<b>120</b>
<b>VI. Detainees Rendered From Other African Countries to Libya .....</b>	<b>132</b>
Ismail Omar Gebril al-Lwatty .....	132
Mafud al-Sadiq Embaya Abdullah .....	134
Abdullah Mohammed Omar al-Tawaty.....	136
Othman Salah (Sheikh Othman) .....	137
<b>VII. International Legal Standards.....</b>	<b>141</b>
<b>Recommendations .....</b>	<b>149</b>
<b>Acknowledgments .....</b>	<b>154</b>
<b>Appendix I: Tripoli Documents .....</b>	<b>156</b>
<b>Appendix II: Shoroeyia Drawings .....</b>	<b>204</b>

## Summary

All we seek is justice.... We hope the new Libya, freed from its dictator, will have positive relationships with the West. But this relationship must be built on respect and justice. Only by admitting and apologizing for past mistakes ... can we move forward together as friends.

—Abdul Hakim Belhadj, military commander during the Libyan uprising who had been forcibly returned to Libya in 2004 with US and UK involvement, Libya, April 12, 2012<sup>1</sup>

When rebel forces overtook Tripoli in August 2011, prison doors were opened and office files exposed, revealing startling new information about Libya's relations with other countries. One such revelation, documented in this report, is the degree of involvement of the United States government under the Bush administration in the arrest of opponents of the former Libyan Leader, Muammar Gaddafi, living abroad, the subsequent torture and other ill-treatment of many of them in US custody, and their forced transfer to back to Libya.

The United States played the most extensive role in the abuses, but other countries, notably the United Kingdom, were also involved.

This is an important chapter in the larger story of the secret and abusive US detention program established under the government of George W. Bush after the September 11, 2001 attacks, and the rendition of individuals to countries with known records of torture.<sup>2</sup>

---

<sup>1</sup> "Watch Libyan rendition victim Abdel Hakim Belhadj talk to the European Parliament," Reprieve.org, April 12, 2012, at 0:16 and 2:30, [http://www.reprieve.org.uk/tvandradio/Belhadj\\_European\\_Parliament](http://www.reprieve.org.uk/tvandradio/Belhadj_European_Parliament) (accessed June 15, 2012).

<sup>2</sup> Rendition is the transfer of an individual between governments. Transferring someone to another country without providing them an adequate opportunity to contest that transfer violates basic rights under international human rights law. Transferring someone to another government where they would face a serious risk of torture or other ill-treatment is unlawful. Transferring an individual to the custody of another government for the purpose of torture, usually to obtain information, is a practice commonly referred to as rendition to torture, which did not appear to be the intent of US renditions to Libya in the cases described in this report. US returns to Libya may have been motivated by the likelihood that finding another country to accept them might have been difficult or by an effort to improve relations with Gaddafi.

This report is based mostly on Human Rights Watch interviews with 14 former detainees now residing freely in post-Gaddafi Libya and information contained in Libyan government files discovered abandoned immediately after Gaddafi's fall (the "Tripoli Documents"). It provides detailed evidence of torture and other ill-treatment of detainees in US custody, including a credible account of "waterboarding," and a similar account of water abuse that brings the victim close to suffocation. Both types of abuse amount to torture. The allegations cast serious doubts on prior assertions from US government officials that only three people were waterboarded in US custody. They also reflect just how little the public still knows about what went on in the US secret detention program.

The report also sheds light on the failure of the George W. Bush administration, in the pursuit of suspects behind the September 11, 2001 attacks, to distinguish between Islamists who were in fact targeting the United States and those who may simply have been engaged in armed opposition against their own repressive regimes. This failure risked aligning the United States with brutal dictators and aided their efforts to dismiss all political opponents as terrorists.

The report examines the roles of other governments in the abuse of detainees in custody and in unlawful renditions to Libya despite demonstrable evidence the detainees would be seriously mistreated upon return. Countries linked to these accounts include: Afghanistan, Chad, China and Hong Kong, Malaysia, Mali, Mauritania, Morocco, the Netherlands, Pakistan, Sudan, Thailand, and the United Kingdom.

Finally, the report shows that individuals rendered to Libya were tortured or otherwise ill-treated in Libyan prisons, including in two cases where the Tripoli Documents make clear the United States sought assurances that their basic rights would be respected. All were held in incommunicado detention—many in solitary confinement—for prolonged periods without trial. When finally tried, they found that the proceedings fell far short of international fair trial standards.

Most of the former detainees interviewed for this report said they had been members of the Libyan Islamist Fighting Group (LIFG)—a group opposed to Gaddafi's rule that began to organize in Libya in the late 1980s and took more formal shape in Afghanistan in the early 1990s. At that time, Islamist opposition groups were springing up across the Middle East,

North Africa, and Asia in response to governments they deemed corrupt, oppressive, and not sufficiently Islamic.

Libya was no exception. In 1977, several years after Gaddafi took power, he imposed his unique political system, the *Jamahiriya*, or “state of the masses,” on the country. The government confiscated property, and began regulating every aspect of life, from religion to economics to education, in entirely new and often incomprehensible ways. Many Libyans, including traditional Muslims who were particularly outraged by the changes Gaddafi made to the practice of Islam and considered them blasphemous, expressed their opposition. Gaddafi put down dissent brutally, focusing in particular on Islamist opposition groups who, due to their alignment with Islamist groups abroad and the deep devotion of many members, he treated as a dangerous threat. Those suspected of even the slightest connection with the movement were rounded up, imprisoned, and sometimes executed, including in public and broadcast on television. It is in the context of this crackdown that the LIFG began to organize and set out, from bases both within and outside Libya, to overthrow Gaddafi.

Virtually all the former Libyan detainees interviewed by Human Rights Watch said that they fled the country in the late 1980s because of Gaddafi’s repressive policies against organized Islamic opposition groups and against persons perceived to be associated with such groups, due to their religious practices. Some joined the LIFG while in Libya and others once outside the country. All but one said they participated in the fighting in Afghanistan that eventually defeated the Soviet-installed government of Mohammed Najibullah in 1992 and used the training they gained there for LIFG-led anti-Gaddafi efforts.

After the September 11 attacks on the United States, being Libyan without documentation in Afghanistan, and being part of an armed Islamic opposition group, placed these Libyan expatriates at high risk of arrest. That was true even if—as all those interviewed for this report claim—their group was not at war with the West. And so many of them fled, along with their families, moving from country to country, including to destinations such as Malaysia and Hong Kong as well as Mali and Mauritania. It was in these countries that they were taken into custody before being sent elsewhere.

For many of the individuals profiled here, this will be the first time their stories are told because until last year they were locked up in Libyan prisons.

These stories provide new details about serious human rights violations in US detention sites, US and UK collaboration with the Gaddafi government, and the roles of several other countries that assisted in renditions. This information includes:

- ***New accounts of abuse in secret Central Intelligence Agency (CIA) black sites:*** Five former LIFG members told Human Rights Watch that they were detained in US run-prisons in Afghanistan for between eight months and two years. The abuse allegedly included: being chained to walls naked—sometimes while diapered—in pitch dark, windowless cells, for weeks or months at a time; being restrained in painful stress positions for long periods of time, being forced into cramped spaces; being beaten and slammed into walls; being kept inside for nearly five months without the ability to bathe; being denied food and being denied sleep by continuous, deafeningly loud Western music, before being rendered back to Libya. The United States never charged them with crimes. Their captors allegedly held them incommunicado, cut off from the outside world, and typically in solitary confinement throughout their Afghan detention. The accounts of these five men provide extensive new evidence that corroborates the few other personal accounts that exist about the same US-run facilities. One of those five, before being transferred to Afghanistan, as well as another former LIFG member interviewed for this report, were also held in a detention facility in Morocco.
- ***New evidence of “waterboarding” torture and a similar practice during interrogations:*** One former detainee, Mohammed Shoroeyia, provided detailed and credible testimony that he was waterboarded on repeated occasions during US interrogations in Afghanistan. While never using the phrase “waterboarding,” he said that after his captors put a hood over his head and strapped him onto a wooden board, “then they start with the water pouring.... They start to pour water to the point where you feel like you are suffocating.” He added that, “they wouldn’t stop until they got some kind of answer from me.” He said a doctor was present during the waterboarding and that this happened numerous times, so many times he could not count. A second detainee in Afghanistan described being subjected to a water suffocation practice similar to waterboarding, and said that he was threatened with use of the board. A doctor was present during his suffocation-inducing abuse as well. The allegations of waterboarding contradict statements about the practice from senior US officials, such as former CIA Director Michael Hayden, who

testified to the Senate that the CIA waterboarded only three individuals—Khalid Sheikh Mohammed, Abu Zubaydah, and Abd al-Rahim al-Nashiri.<sup>3</sup> Former President Bush similarly declared in his memoirs that only three detainees in CIA custody were waterboarded.<sup>4</sup> Former Defense Secretary Donald Rumsfeld has also denied the use of waterboarding by the US military.<sup>5</sup>

- ***Unlawful rendition:*** All interviewees said their captors forcibly returned them to Libya at a time when Libya’s record on torture made clear they would face a serious risk of abuse upon return. All had expressed deep fears to their captors about going back to Libya and five of them said that they specifically asked for asylum. One of them, Muhammed Abu Farsan, sought asylum in the Netherlands while in transit between China and Morocco. He said his asylum application was ultimately denied and he was sent to Sudan, where he held a passport. But Sudanese authorities kept him in detention and, shortly after his arrival, individuals representing themselves as CIA officers interrogated him on three different days. Within two weeks he was sent back to Libya. Though the Netherlands is the only government that actually had provided any of the Libyans we interviewed with an opportunity to challenge their transfer, the Tripoli Documents contain information suggesting Dutch officials might have been aware that Abu Farsan would ultimately be sent to Libya from Sudan. To the extent they knew that there was a genuine risk he would be returned to Libya, they violated his rights against unlawful return.
- ***More information about Western collusion with the Gaddafi government:*** The Human Rights Watch interviews and the Tripoli Documents present new details showing a close degree of cooperation among the US, the UK, and other Western governments with regard to the forcible return and subsequent interrogation of

---

<sup>3</sup> Testimony of Michael Hayden in front of the Senate Select Committee on Intelligence, February 5, 2008, <http://www.intelligence.senate.gov/pdfs/110824.pdf>, p. 71-72 (accessed July 2, 2012) (“Let me make it very clear and to state so officially in front of this Committee that waterboarding has been used on only three detainees.”). The CIA waterboarded Khalid Sheikh Mohammed 183 times, Abu Zubaydah at least 83 times, and Abd al-Rahim al-Nashiri twice. CIA Office of the Inspector General, “Special Review: Counterterrorism Detention and Interrogation Activities (September 2001 – October 2003),” May 7, 2004, declassified in August 2009, <http://graphics8.nytimes.com/packages/pdf/politics/20090825-DETAIN/2004CIAIG.pdf> (accessed July 2, 2012), (“CIA OIG report”), p. 90-91.

<sup>4</sup> George W. Bush, *Decision Points* (New York, Crown Publishers, 2012), p. 171 (“Of the thousands of terrorists we captured in the years after 9/11, about a hundred were placed into the CIA program. About a third of those were questioned using enhanced techniques. Three were waterboarded.”).

<sup>5</sup> Donald Rumsfeld, *Known and Unknown: A Memoir* (New York: Sentinel, 2012), p. 585 (“To my knowledge, no U.S. military personnel involved in interrogations waterboarded any detainees—not at Guantanamo Bay, or anywhere else in the world.”).

Gaddafi opponents in Libya. Ten of the fourteen Libyans interviewed for this report were rendered back to Libya within about year of the date when Libya, the United States and the United Kingdom had formally mended their relations, seven within the five months. The mending of relations was very publically marked by a visit from British Prime Minister at the time, Tony Blair, to Libya on March 25, 2004. The collusion is ironic, given that years later these same governments would end up assisting Gaddafi's opponents in their efforts to overthrow the Libyan leader. Several of those opponents are now in leadership positions and are important political actors in Libya.

- *Ibn al-Sheikh al-Libi*: Al-Libi's case is significant, among other reasons, because the United States relied on statements obtained through his interrogation while in CIA custody to justify the 2003 invasion of Iraq: Al-Libi died in a Libyan prison in 2009—a suicide, according to Libyan authorities at the time—so it is difficult to obtain information about him today. But by talking to family members and others detained with him in Pakistan, Afghanistan, and Libya, Human Rights Watch has pieced together some new details about al-Libi's time in CIA custody and circumstances surrounding his death. Human Rights Watch also observed photos of al-Libi that Libyan prison officials appear to have taken on the morning of his death which allegedly depict him in the manner he was found in his cell. The photos show bruising on parts of his body.

The United States, Libya, and most of the other countries discussed in this report are party to important international human rights treaties, including the International Covenant on Civil and Political Rights and the Convention against Torture and Other Cruel, Inhuman or Degrading Treatment or Punishment. Persons apprehended in armed conflict situations would also have been protected by the Geneva Conventions of 1949. These treaties prohibit not only torture, but all cruel, inhuman and degrading treatment. Importantly, they also prohibit sending an individual to a country where that person would face a genuine risk of torture or ill-treatment.

In discussing rendition policies, former Bush administration officials have tried to justify the forced returns that took place during the administration by saying they always got “promises” from the receiving countries or “diplomatic assurances” the transferees would be treated humanely. As evidenced by US State Department country reports on human

rights in the mid-2000s, however, the US government was well aware of the torture and ill-treatment taking place in Libyan prisons.<sup>6</sup> The Gaddafi government's many executions of its opponents after summary trials would have made it obvious to anyone involved in the rendition of LIFG members to Libya that they would be at grave risk. The US government's perfunctory resort to diplomatic assurances—unenforceable agreements between governments to not harm a person being transferred, shown in the Tripoli Documents to have been used in two transfers—reflect a callous disregard for the lives and wellbeing of people who the United States never should have returned to Libya.

Several individuals interviewed for this report said they endured physical abuse and mistreatment in Libya, some of which amounted to torture. This included being beaten with wooden sticks<sup>7</sup> and steel pipes;<sup>8</sup> whipped,<sup>9</sup> including with ropes<sup>10</sup> and electric cables;<sup>11</sup> slapped, kicked and punched;<sup>12</sup> and administered electric shocks.<sup>13</sup>

At the same time, other interviewees said they were not subjected to physical abuse in Libyan custody. Some speculated this may have been due to prison reforms initiated by Muammar Gaddafi's son, Saif Gaddafi, or agreements they had heard were made between the United States and Libya (perhaps diplomatic assurances) that transferees would not be mistreated.<sup>14</sup> But, neither Saif Gaddafi's reforms nor US diplomatic assurances, if obtained, appear to have protected those detainees who were subjected to torture and ill-

---

<sup>6</sup> US State Department, Bureau of Democracy, Human Rights, and Labor, "Country Reports on Human Rights Practices – 2004: Libya," <http://www.state.gov/j/drl/rls/hrrpt/2004/41727.htm> (accessed August 15, 2012); and "Country Reports on Human Rights Practices – 2006: Libya," <http://www.state.gov/j/drl/rls/hrrpt/2006/78858.htm>, (accessed August 15, 2012). The UK was also concerned about human rights abuses in Libya during this period. The 2004 human rights report by the UK Foreign Office states, "[T]he UK remains seriously concerned by the human rights situation in Libya, including restrictions on freedom of expression and assembly, political prisoners, arbitrary detention and conditions in Libyan prisons." UK Foreign & Commonwealth Office, "Human Rights: Annual Report 2004," <http://fcohrdreport.readandcomment.com/wp-content/uploads/2011/01/human-rights-report-2004.pdf> (accessed August 27, 2012), p. 67.

<sup>7</sup> Human Rights Watch interviews with Mohammed al-Shoroeiya (Shoroeiya), Tripoli, Libya, March 18, 2012; and Sami Mostefa al-Saadi (Saadi), Tripoli, Libya, March 14, 2012.

<sup>8</sup> Human Rights Watch interview with Shoroeiya, March 18, 2012.

<sup>9</sup> Human Rights Watch interview with Adusalam Abdulhadi Omar as-Safrani (Safrani), Benghazi, Libya, March 20, 2012.

<sup>10</sup> Human Rights Watch interview with Saadi, March 14, 2012.

<sup>11</sup> Human Rights Watch interview with Shoroeiya, March 18, 2012; Human Rights Watch interview with Saadi, March 14, 2012.

<sup>12</sup> Human Rights Watch interviews with Safrani, March 20, 2012; and Saadi, March 14, 2012.

<sup>13</sup> Ibid.

<sup>14</sup> Human Rights Watch interviews with Khalid al-Sharif (Sharif), Tripoli, Libya, March 14, 2012; Shoroeiya, March 18, 2012; Muhammed Abu Farsan (Abu Farsan), Tripoli, Libya, March 26, 2012; Sheikh Othman Salah, Tripoli, Libya, March 15, 2012; and Saadi, March 14, 2012.



treatment. Nor did they protect detainees from being placed in solitary confinement—which can amount to torture—ensure their access to family members and legal counsel, or make sure they were promptly charged and fairly tried. Typically detainees had no lawyers and were denied family visits, sometimes for as long as two years.<sup>15</sup> All of those interviewed said they were held for years before finally being charged with any offense. Once charged, they were appointed a lawyer to whom they either never spoke or who did not assist in their defense.<sup>16</sup> They faced summary trials, and all detainees interviewed for this report were convicted, receiving sentences of lengthy prison terms up to life imprisonment, or the death penalty. At least three said they were subsequently interrogated in Libyan prisons by US, UK, or other foreign agents.<sup>17</sup>

## Summary of the Cases

*Detentions in Afghanistan and Morocco:* Of the men interviewed for this report, the five who experienced the worst abuses and spent the longest period in secret US detention are Khalid al-Sharif (Sharif); Mohammed Ahmed Mohammed al-Shoroeiya (Shoroeiya); Majid Mokhtar Sasy al-Maghrebi (Maghrebi); Saleh Hadiyah Abu Abdullah Di'iki (Di'iki); and Mustafa Jawda al-Mehdi (Mehdi). All but Mehdi appear to have been held in the same locations for their first period of detention which they all said was in a US-run detention facility in Afghanistan. The four were then moved to a second location, apparently also in Afghanistan, to which Mehdi was later brought. In total, Sharif was in both locations for two years, Shoroeiya for about 16 months, Maghrebi for about eight months, and Di'iki also for about eight months. Mehdi was only in the second location and he appears to have been detained there for about fourteen months. Prior to his detention in Afghanistan,

---

<sup>15</sup> Human Rights Watch interviews with Shoroeiya, March 18, 2012; Majid al-Maghrebi (Maghrebi), Tripoli, Libya, March 16, 2012; Sharif, March 14, 2012; Osmail Omar Gebril al-Lwatty (Lwatty), Tripoli, Libya, March 17, 2012; Abu Farsan, March 26, 2012; and Saleh Hadiyah Abu Abdullah Di'iki (Di'iki), Tripoli, Libya, March 18, 2012.

<sup>16</sup> Human Rights Watch interviews with Shoroeiya, March 18, 2012 (“I did not have an opportunity to talk to the lawyer. Lawyer was a man. Spoke to him only once. Just time to introduce himself.”); and Mustafa Jawda al-Mehdi (Mehdi), Tripoli, Libya, March 14, 2012 (“Yes. I was appointed a public defender. I didn’t see her or even speak to her.”).

<sup>17</sup> Abdul Hakim Belhadj (Belhadj) said he was interrogated by Americans four times, as well as by the British, French, Spanish, Germans, and Italians. Kim Sengupta, “Libyan rebel leader says MI6 knew he was tortured,” *The Independent*, September 6, 2011, <http://www.independent.co.uk/news/world/africa/libyan-rebel-leader-says-mi6-knew-he-was-tortured-2349778.html> (accessed August 27, 2012). See also Chulov, “MI6 knew I was tortured, says Libyan rebel leader,” *The Guardian*, <http://www.guardian.co.uk/world/2011/sep/05/abdul-hakim-belhaj-libya-mi6-torture?INTCMP=ILCNETTXT3487> (accessed August 29, 2012). Saadi said he was interrogated by American, British, and Italian intelligence agencies, as well as by some agents who were speaking French, though he was not sure if they were French. Sharif said he was interrogated by French intelligence agents. Human Rights Watch interviews with Saadi, March 14, 2012; and Sharif, March 14, 2012.

Di'iki said he was also held in a facility in Morocco for about a month where he said he was interrogated by US personnel though it is not clear if they were running the facility. In addition to these five, Human Rights Watch also interviewed Mustafa Salim Ali el-Madaghi (Madaghi), who was described in the Tripoli Documents as Di'iki's deputy.<sup>18</sup> He was arrested in Mauritania, sent to Morocco, held there for about five weeks, and then rendered to Libya. All six were senior members of the LIFG. Khalid al-Sharif, deputy to Head of the LIFG, Abdul Hakim Belhadj (see below), being the most senior member.

*Transfers to Libya That Began in Asia:* For three interviewees, their returns to Gaddafi's Libya began in Asia. Two of these three cases—those of Abdul Hakim Belhadj and Sami Mostafa al-Saadi, are already well documented. Information about US and UK involvement in their renditions was revealed when the Tripoli Documents were discovered last year and a number of the documents made public.<sup>19</sup> Belhadj is the former head of the LIFG and a longtime opponent of Gaddafi. He and his wife were taken into custody in Malaysia with the help of the United Kingdom's Secret Intelligence Service (commonly known as MI6) and detained for several days by the CIA in Thailand. The United States then sent him to Libya around March 9, 2004. Libyan intelligence Chief Musa Kusa had Belhadj brought directly to him. "I've been waiting for you," he reportedly told Belhadj.<sup>20</sup> Belhadj's transfer occurred just weeks before UK Prime Minister Tony Blair flew to Tripoli on March 25 for a very public rapprochement with Gaddafi.<sup>21</sup> The same day, Anglo-Dutch oil giant Shell announced it had signed a deal worth up to £550 million (approximately \$1 billion US) for gas exploration rights off the Libyan coast.<sup>22</sup>

Saadi had been a senior LIFG leader and was the group's religious leader and religious law expert. The Tripoli Documents contain communications from the CIA offering to help the Libyan government secure Saadi's return to Libya and confirming MI6 involvement as well. Saadi was rendered to Libya from Hong Kong just days after Blair's visit to Libya. Five other former LIFG members interviewed for this report were also rendered to Libya that year, and

---

<sup>18</sup> Tripoli Document 2142 refers to Madaghi by one of his aliases, "Mustafa Salim Ali Moderi Tarabulsi, aka Shaykh Musa."

<sup>19</sup> Ian Cobain, "Libyan dissident tortured by Gaddafi to sue Britain over rendition," *The Guardian*, October 6, 2011, <http://www.guardian.co.uk/world/2011/oct/06/libyan-dissident-tortured-sues-britain> (accessed April 22, 2012).

<sup>20</sup> "Watch Libyan rendition victim Abdel Hakim Belhadj talk to the European Parliament," Reprieve.org, April 12, 2012, at 1:38.

<sup>21</sup> "Blair hails new Libyan relations," BBC News, March 25, 2004, [http://news.bbc.co.uk/2/hi/uk\\_news/politics/3566545.stm](http://news.bbc.co.uk/2/hi/uk_news/politics/3566545.stm) (accessed June 17, 2012).

<sup>22</sup> Ibid.

two more the following April. Communications contained in the Tripoli Documents, relating to Belhadj and Saadi, are a key part of a lawsuit against the UK government.<sup>23</sup> They have also formed the basis of an investigation by the UK police into the government's role in their rendition.<sup>24</sup>

In addition to these eight, Human Rights Watch interviewed another senior LIFG member, Muhammed Abu Farsan, who had been with Belhadj and Saadi in Asia before they were detained. As described above, Abu Farsan sought but failed to obtain asylum in the Netherlands, which sent him to Sudan. In Sudan he was interviewed by individuals representing themselves as being from the CIA on three different occasions. Within two weeks, Sudan returned him to Libya.

*Transfer from Guantanamo Bay:* We also interviewed Abdusalam Abdulhadi Omar as-Safrani, who as of this report's writing was one of two former Guantanamo detainees sent back to Libya by the US. He said he was not a member of the LIFG. He was detained with Ibn-al-Sheikh al-Libi (see below) by US and Pakistani forces before being sent to Guantanamo.

*Ibn al-Sheikh al-Libi (Sheikh al-Libi):* Sheikh al-Libi, also reportedly not a member of the LIFG, was held in US custody for years, allegedly tortured, and then rendered to Libya. We could not interview him for this report because he died in Libyan custody, allegedly by suicide. His rendition and torture is of particular importance because it produced intelligence that the CIA itself has recognized was unreliable but that nevertheless played a significant role in justifying the US invasion of Iraq in 2003.

---

<sup>23</sup> Cobain, "Libyan dissident tortured by Gaddafi to sue Britain over rendition," *The Guardian* ("[T]he case currently relies upon a number of documents that Human Rights Watch, the New York-based NGO, found last month."); See also "Investigation into rendition welcomed," Leigh Day & Co. Solicitors news release, January 12, 2012, <http://www.leighday.co.uk/News/2012/January-2012/Investigation-into-Rendition-Welcomed> (accessed August 27, 2012) (Leigh Day & Co. is the law firm representing both Belhadj and Saadi and their families; the press release states "[a]fter Gaddafi was overthrown documents were discovered by Human Rights Watch which allegedly show how British personnel were instrumental in his detention and rendition." Claims filed by Leigh Day & Co. rely upon a number of these documents.); and Richard Norton-Taylor, "Libyan rebel leader sues Britain over rendition ordeal," *The Guardian*, December 19, 2012, <http://www.guardian.co.uk/world/2011/dec/19/libyan-rebel-abdel-hakim-belhadj?INTCMP=ILCNETTXT3487> (accessed April 22, 2012).

<sup>24</sup> "Joint statement by the Director of Public Prosecutions and the Metropolitan Police Service," Crown Prosecution Service news release, January 1, 2012, [http://www.cps.gov.uk/news/press\\_statements/joint\\_statement\\_by\\_the\\_director\\_of\\_public\\_prosecutions\\_and\\_the\\_metropolitan\\_police\\_service/](http://www.cps.gov.uk/news/press_statements/joint_statement_by_the_director_of_public_prosecutions_and_the_metropolitan_police_service/) (accessed April 22, 2012).

*Detainees Rendered from African Countries to Libya:* We interviewed four other Libyans picked up in different places in Africa and then transferred to Libya: one from Sudan, Ismail Omar Gebril al-Lwatty (Lwatty); one from Chad, Mafud al-Sadiq Embaya Abdullah (Embaya); and two from Mali, Abdullah Mohammed Omar al-Tawaty (Tawaty) and Othman Salah (Salah). These interviews contained less evidence than the others of foreign or Western government involvement in the actual transfer, though there are indications that Western governments were involved in the initial apprehensions and subsequent interrogations. The African countries themselves, however, were equally obliged not to render these individuals to Libya, without process and against their will.

Most of the Libyans profiled in this report were imprisoned until February 16, 2011, when the uprisings against Gaddafi began. LIFG leader Abdul Hakim Belhadj, his deputy, Khalid Sharif, and LIFG religious leader Sami al-Saadi were released a year earlier, on March 23, 2010, as part of a negotiated release of hundreds of prisoners. Belhadj, Saadi and Sharif had to publically renounce their aim of overthrowing the government by force as part of the deal.

Many of those interviewed were also involved in the uprisings against Gaddafi. Sharif, Saadi, and Di'iki were all rearrested during this time for anti-Gaddafi activities and held until August 2011, when Tripoli fell to rebel forces. Belhadj commanded a brigade that played a key role in the uprisings and the taking of Tripoli. Shoroeiya, Sharif, and others interviewed for this report said that many former LIFG members who managed to escape arrest after the uprisings began, but are not profiled here, participated politically in the uprisings and militarily in organizing and training rebel forces. Belhadj and Saadi both ran as candidates for their respective political parties during the July 7, 2012 elections.<sup>25</sup> US diplomats have engaged with Belhadj and his party since they emerged as important players in Libya's new democratic landscape, and several US Senators, including John McCain, have met with him. Sharif is now head of the Libyan National Guard. One of his responsibilities is providing security for facilities holding high value detainees (mostly officials of the former Gaddafi government) now in government custody. Di'iki also works at the Libyan National Guard and has similar

---

<sup>25</sup> Belhadj ran as a candidate under the Islamist political party Hizb al-Watan and Saadi as a candidate under the part al-Umma al-Wasat. Neither did as well as expected. Omar Ashour, "Libya's Defeated Islamists," July 17, 2012, <http://www.project-syndicate.org/commentary/libya-s-defeated-islamists> (accessed on July 18, 2012).

responsibilities. Mehdi and Shoroieya are prominent members of the same political parties to which Belhadj and Saadi belong, respectively.

## Key Recommendations

### To the United States Government

- Consistent with its obligations under the Convention against Torture, investigate credible allegations of torture and ill-treatment since September 11, 2001 and implement a system of compensation to ensure all victims can obtain redress.
- Acknowledge past abuses and provide a full accounting of every person that the CIA has held in its custody pursuant to its counterterrorism authority since 2001, including names, dates they left US custody, locations to which they were transferred, and their last known whereabouts.
- Create an independent, nonpartisan commission to investigate the mistreatment of detainees in US custody anywhere in the world since September 11, 2001, including torture, enforced disappearance, and rendition to torture.

### To the Government of the United Kingdom

- Provide a full accounting of the involvement of British security services in the detention or transfer of individuals to other countries without due process since September 11, 2001.
- Set up a new, judge-led inquiry into the UK's involvement in detainee abuse and renditions to torture with full independence from the government and authority to allow it to establish the truth.

### To the Government of Libya

- Promptly investigate all allegations of torture and ill-treatment in detention facilities run by the state and armed groups in a thorough and impartial way.
- Hold accountable all those responsible for using torture or ill-treatment against persons in custody.

### To the Governments of Pakistan, the Netherlands, China, Hong Kong, Malaysia, Thailand, Chad, Mauritania, Mali, Morocco, and Sudan

- Conduct a thorough and impartial investigation into the role each government played in either the detention and abuse or the transfer or rendition of individuals

identified in this report to Libya, where they faced a substantial risk of torture or persecution.

- Where warranted, prosecute individuals found to have engaged in torture or cruel, inhuman, or degrading treatment and provide a means for victims to obtain redress.

## Methodology

This report is based primarily on interviews Human Rights Watch conducted during a research trip to Libya from March 14 to March 27, 2012; documents that Human Rights Watch discovered in Libyan foreign intelligence chief Musa Kusa's office on September 3, 2011; and Human Rights Watch research on unlawful rendition and secret detention by the United States and other governments over the past decade.

During its March 2012 trip to Libya, Human Rights Watch conducted in-depth interviews with 14 former detainees who had been transferred to Libya between 2004 and 2006. Before each interview, we informed interviewees of its purpose and the kinds of issues that would be covered, and asked whether they wanted to participate. We informed them that they could discontinue the interview at any time or decline to answer specific questions without consequence. We did not offer or provide incentives to persons we interviewed. We conducted each interview individually and in private.

Human Rights Watch was previously aware that seven of these individuals had been transferred to Libya. We had already interviewed four of them in 2009 while they were still in Libya's Abu Salim prison, but had conducted those interviews in an open courtyard, occasionally within the earshot of guards.<sup>26</sup> The fall of the Gaddafi government and the prisoners' release from detention provided Human Rights Watch with an opportunity to speak to them in private, without the stress of prison conditions, and in greater depth about their experiences.

These interviews and documents led Human Rights Watch to other individuals who had also been unlawfully rendered, detained, and interrogated with varying levels of foreign government involvement. In addition, Human Rights Watch worked with Sheikh Othman, a former LIFG member who worked in the Tripoli Military Defense Council. He was in charge

---

<sup>26</sup> In 2009 Human Rights Watch interviewed Abdul Hakim Belhadj, Mohammed Ahmed Mohammed al-Shoroeiya, Majid al-Maghrebi, and Mostafa al-Mehdi in Abu Salim. Human Rights Watch also spoke briefly to Ibn al-Sheikh al-Libi during the same visit, but he refused to speak to us, saying "[w]here were you when I was being tortured in American jails?" "Libya/US: Investigate Death of Former CIA Prisoner," Human Rights Watch news release, May 11, 2009, <http://www.hrw.org/news/2009/05/11/libyaus-investigate-death-former-cia-prisoner>.



of compiling the names of those who had been returned to Libya against their will, with foreign government involvement. He himself had been rendered to Libya from Mali in 2006. Othman provided Human Rights Watch with the names and contact information for 21 former prisoners who he said were returned to Libya during the Gaddafi era with US, UK, or other foreign government involvement. Much of this information overlapped with information we already had, but some of it was new. Of those on Othman's list that we were not able to interview, one was no longer alive (Ibn al-Sheikh al-Libi). Another, Abu Sufian Ibrahim Ahmed Hamuda Bin Qumu, the only other Guantanamo detainee to be returned to Libya besides Abdusalam Abdulhadi Omar as-Safrani, refused to speak with us. We were unable to reach six others. As a result, we were not able to confirm or deny these other alleged transfers to Libya. In addition, Othman said that another 15 people had been turned over to Libya from prisons in Sudan, more than 70 from Saudi Arabia, and at least eight from Jordan. Due to limited time, Human Rights Watch was not able to investigate these claims.

Human Rights Watch interviewed some family members of people who had been returned to Libya, as well as family members and former cellmates of Ibn al-Sheikh al-Libi, who died while in Libyan custody.

### **Tripoli Documents**

On September 3, 2011, Human Rights Watch discovered a number of Gaddafi-era files, abandoned, in the offices of former Libyan intelligence chief Musa Kusa in Tripoli.<sup>27</sup> Scores of those documents—several of which are presented here for the first time—provide important information on the high level of cooperation between the United States and the United Kingdom in the rendition of Gaddafi's political opponents to Libya. (See Appendix 1 for a complete list of the documents drawn on in this report.)

The documents include communications between Musa Kusa's office and the CIA, and between Kusa's office and the MI6. They show a high level of cooperation between the United States, the United Kingdom, and the government of former Libyan leader Muammar Gaddafi on the transfer of Gaddafi's opponents into Libyan custody. The documents are

---

<sup>27</sup> "US/UK: Documents Reveal Libya Rendition Details," Human Rights Watch news release, September 9, 2011, <http://www.hrw.org/news/2011/09/08/usuk-documents-reveal-libya-rendition-details>.

significant because they shed light on the still opaque CIA renditions program, identify former detainees by name, and provide corroborating evidence in several specific cases, most notably confirming the involvement of the US, the UK, and other governments.

### **Past Human Rights Watch Interviews in Libya**

Since the September 11, 2001 attacks, Human Rights Watch, journalists and other nongovernmental organizations have reported on CIA secret detention sites, tracked the names of missing detainees believed to be in US custody, and requested information as to their whereabouts.<sup>28</sup> In 2006 and 2007, Human Rights Watch received reports from Libyans abroad that several individuals who had been in US custody had since been sent back to Libya. Some media outlets also reported these returns.<sup>29</sup> By February 2009, Human Rights Watch had the names of seven Libyans we believed had been detained by the CIA and transferred to Libya. In April 2009 Human Rights Watch got access to the notorious Abu Salim prison in Tripoli, the main prison where the government held political prisoners and the site of a massacre in 1996 where roughly 1,200 inmates were killed within a few hours. During the 2009 visit, we confirmed that five of the seven had indeed been transferred to Libyan custody and we were able to interview four of them, though only for a limited period of time and not entirely in private. The fifth, Ali Mohammed al-Fakheri, also known as Ibn al-Sheikh al-Libi, declined to speak with us. Two weeks later, according to the Libyan government, he committed suicide.<sup>30</sup>

---

<sup>28</sup> Human Rights Watch, *The United States' "Disappeared": The CIA's Long-Term "Ghost Detainees,"* October 12, 2004, <http://www.hrw.org/reports/2004/10/12/united-states-disappeared-cias-long-term-ghost-detainees>; Human Rights Watch, *List of "Ghost Prisoners" Possibly in CIA Custody,* November 30, 2005, <http://www.hrw.org/reports/2005/11/30/list-ghost-prisoners-possibly-cia-custody>; Human Rights Watch, *Ghost Prisoner: Two Years in Secret CIA Detention*, Vol. 19, No. 1(G), February 27, 2007, <http://www.hrw.org/sites/default/files/reports/us0207webwcover.pdf>; Human Rights Watch, *Off the Record: US Responsibility for Enforced Disappearances in the "War on Terror,"* June 7, 2007, <http://www.hrw.org/legacy/backgrounders/usa/cto607/cto607web.pdf>; Human Rights Watch, "Letter to Bush Requesting Information on Missing Detainees," February 27, 2007, <http://www.hrw.org/news/2007/02/26/letter-bush-requesting-information-missing-detainees>; See also Human Rights Watch Statement on US Secret Detention Facilities in Europe, November 7, 2005, <http://www.hrw.org/news/2005/11/06/human-rights-watch-statement-us-secret-detention-facilities-europe>; and Human Rights Watch, "US Operated Secret 'Dark Prison' in Kabul," December 20, 2005, <http://www.hrw.org/news/2005/12/18/us-operated-secret-dark-prison-kabul>.

<sup>29</sup> Michael Isikoff, "The Missing Terrorist," *Newsweek*, May 27, 2007, <http://www.thedailybeast.com/newsweek/2007/05/27/the-missing-terrorist.html> (accessed July 31, 2012); Craig Whitlock, "From CIA Jails, Inmates Fade Into Obscurity," *Washington Post*, October 27, 2007, [http://www.washingtonpost.com/wp-dyn/content/article/2007/10/26/AR2007102602326\\_pf.html](http://www.washingtonpost.com/wp-dyn/content/article/2007/10/26/AR2007102602326_pf.html) (accessed July 31, 2012).

<sup>30</sup> "Libya/US: Investigate Death of Former CIA Prisoner," Human Rights Watch news release; See also Peter Finn, "Detainee Who Gave False Iraq Data Dies in Prison in Libya," *Washington Post*, May 12, 2009, <http://www.washingtonpost.com/wp-dyn/content/article/2009/05/11/AR2009051103412.html> (accessed August 29, 2012).

# I. Background

## Libya from the 1970s to the 1990s

Twelve of the fifteen men profiled in this report said they left Libya between 1988 and 1990. Of the three others, one left in 1991 and the others in 1996.<sup>31</sup> Libya at the time was a brutal police state.<sup>32</sup> Dissidents were arbitrarily arrested and held for years without charge, and often for long periods in incommunicado detention.<sup>33</sup> Torture of those in custody was rampant.<sup>34</sup> Family members of suspected opponents of the government were harassed, threatened, and detained.<sup>35</sup> It was a country in which the death penalty could be imposed on “anyone who calls for the establishment of any association or party which is against the Revolution in purpose and means.”<sup>36</sup>

Leading up to this period Gaddafi had developed a unique political philosophy, a hybrid of socialism and Islam called the Third Universal Theory, which sought independence from communism and capitalism. This theory was enshrined in the “Green Book,” which he wrote to present his theory of a system of government called *Jamahiriyah*, or “state of the masses.”<sup>37</sup> According to the Green Book, the *Jamahiriyah* system was the final evolution of democracy, because citizens did not elect representatives but participated themselves

---

<sup>31</sup> Mohammed Shoroieiya, Abdullah Mohammed Omar al-Tawaty, and Mafud al-Sadiq Embaya Abdullah left Libya after 1990, Shoroieiya in 1991, and Tawaty and Embaya in 1996.

<sup>32</sup> Amnesty International documented several serious gross human rights violations in Libya during the 1970s and 1980s, including “severe limitations on the rights to freedom of expression and association; arbitrary arrests and detentions of thousands of real or perceived opponents of the political system; incommunicado detention; torture or other forms of ill-treatment; grossly unfair trials; unlawful killings and summary executions; and the imposition of the death penalty including for the peaceful exercise of the right to freedom of expression and association.” See Amnesty International, *‘Libya of Tomorrow’: What hope for human rights*, MDE 19/007/2010, June 2010, <http://www.amnesty.org/en/library/asset/MDE19/007/2010/en/65e2d9ca-3b76-4ea8-968f-5d76e1591b9c/mde190072010en.pdf> (accessed July 24, 2012), p. 18.

<sup>33</sup> Ibid.

<sup>34</sup> See Human Rights Watch, *Libya—Words to Deeds: The Urgent Need for Human Rights Reform*, vol. 18, no. 1(E), January 2006, <http://www.hrw.org/sites/default/files/reports/libya0106webwcover.pdf>, p. 48-49. Fifteen out of thirty-two individuals interviewed by Human Rights Watch that were imprisoned in Libya between 1990 and 2006 said that Libyan security authorities had tortured them during interrogations, usually to extract a confession.

<sup>35</sup> See Human Rights Watch, *Words to Deeds*, p. 38-42.

<sup>36</sup> Libyan Penal Code (1953), art. 173; See also Human Rights Watch, *Words to Deeds*, p. 29; and Amnesty International, *‘Libya of Tomorrow’*, p. 18 (“mass arrests of suspected opponents of the political system and public executions of presumed ‘counter-revolutionary’ elements”).

<sup>37</sup> See Human Rights Watch, *Words to Deeds*, p. 12.

directly in governmental affairs. All citizens were obliged to participate in Basic People's Congresses in their local districts, where they could debate all matters of government. Parliaments were considered "a misrepresentation of the people," and parliamentary governments were "a misleading solution to the problem of democracy." Political parties were considered "contemporary dictatorships."<sup>38</sup> New laws banned any group activity based on a political ideology opposed to these views.<sup>39</sup> As Gaddafi once declared, "It [the revolution] is a moving train. Whoever stands in its way will be crushed."<sup>40</sup>

Gaddafi created Revolutionary Committees, an extensive surveillance system that mobilized citizens to support his political agenda.<sup>41</sup> The rights to freedom of speech and assembly were virtually non-existent.<sup>42</sup> Both local and international phone calls were routinely monitored, as evidenced by the extensive monitoring equipment found after Gaddafi's fall.<sup>43</sup> In the years that followed, police and security forces arbitrarily detained hundreds of Libyans who opposed, or authorities feared could oppose, the new system, subjected them to arbitrary detentions, and many were killed."<sup>44</sup> Libyan authorities referred to these individuals as "stray dogs."<sup>45</sup> On many occasions, the executions were carried out in public and broadcast on television.<sup>46</sup>

---

<sup>38</sup> Human Rights Watch, *Words to Deeds*, p. 12. The Green Book is available in English at <http://www.geocities.com/Athens/8744/readgb.htm> (accessed August 12, 2012).

<sup>39</sup> Human Rights Watch, *Words to Deeds*, p. 13.

<sup>40</sup> Alison Pargeter, *Libya: The Rise and Fall of Qaddafi* (New Haven and London, Yale University Press, 2012), p. 94-95.

<sup>41</sup> *Ibid.*, p. 97. See also Amnesty International, *Libya: Time to Make Human Rights a Reality*, MDE 19/002/2004m April 2004, <http://www.amnesty.org/en/library/asset/MDE19/002/2004/en/ofoco416-d631-11dd-ab95-a13b602c0642/mde190022004en.pdf> (accessed August 12, 2012), p. 5.

<sup>42</sup> Amnesty International, *'Libya of Tomorrow'*, p. 18.

<sup>43</sup> Paul Sonne and Margaret Cocker, "Firms Aided Libyan Spies," *Wall Street Journal*, August 30, 2011, <http://online.wsj.com/article/SB10001424053111904199404576538721260166388.html> (accessed August 12, 2012); Ken Silverstein, "How Kadafi Went From Foe to Ally," *Los Angeles Times*, September 4, 2005, <http://articles.latimes.com/2005/sep/04/world/fg-uslibya4> (accessed May 20, 2012).

<sup>44</sup> Pargeter, *Libya: The Rise and Fall of Qaddafi*, p. 101; See also Cameron Robertson, et. al., "Libya Archive Reveals Pictorial History of Gaddafi's Brutal Reign—Video," *The Guardian*, July 18, 2011, <http://www.guardian.co.uk/world/video/2011/jul/18/libya-muammar-gaddafi> (accessed July 25, 2012); and Amnesty International, *'Libya of Tomorrow'*, p. 18.

<sup>45</sup> Pargeter, *Libya: The Rise and Fall of Qaddafi*, p. 102-103.

<sup>46</sup> Robertson, "Libya Archive Reveals Pictorial History of Gaddafi's Brutal Reign—Video," *The Guardian*; Lindsey Hilsum, *Sandstorm: Libya in the Time of Revolution* (New York: Penguin Press, 2012), p. 89; Pargeter, *Libya: The Rise and Fall of Qaddafi*, p. 101-103; Amnesty International, *'Libya of Tomorrow'*, p. 18.

Gaddafi also made major changes to the practice of Islam in Libya that he expected others to follow.<sup>47</sup> For example, the second source of authority in Sunni Islam, the *Sunnah* (the acts and sayings of the Prophet as told by his companions), was discarded.<sup>48</sup> The Islamic calendar was changed so that it no longer started with the date of the Prophet's migration from Mecca to Medina, but rather with the date of his death ten years later.<sup>49</sup> Libya began fasting for the holy month of Ramadan on a different day from the rest of the Middle East.<sup>50</sup>

The most contentious of these changes was the discarding of the second Sunnah, which was deeply offensive and sacrilegious to Muslims, and not just those in Libya. Though Gaddafi was not the only one advocating this at the time, it was very much a minority position and put him at odds with the clerical establishment, as well as Islamists.<sup>51</sup>

In the early 1980s, a series of fatwas were issued against Gaddafi which proclaimed him a heathen.<sup>52</sup> Libyans who were opposed to Gaddafi's changes began organizing. In turn Gaddafi stepped up surveillance and repression against them.<sup>53</sup> Many victims of the detentions, and killings going on at the time were members of Islamist opposition groups.<sup>54</sup> The former head of Libya's foreign intelligence service, Musa Kusa, once reportedly boasted to foreign visitors that he monitored domestic Islamic extremists so closely that he knew the name of every Libyan with a beard.<sup>55</sup>

---

<sup>47</sup> Sean Kane, "The Libyan Rorschach," *Foreign Policy*, June 14, 2012, [http://mideast.foreignpolicy.com/posts/2012/06/12/the\\_libyan\\_rorschach](http://mideast.foreignpolicy.com/posts/2012/06/12/the_libyan_rorschach) (accessed June 14, 2012).

<sup>48</sup> Pargeter, *Libya: The Rise and Fall of Qaddafi*, p. 114-115.

<sup>49</sup> *Ibid.*, p. 116.

<sup>50</sup> Kane, "The Libyan Rorschach," *Foreign Policy*.

<sup>51</sup> Pargeter, *Libya: The Rise and Fall of Qaddafi*, p. 114-115 ("It is difficult to express just how shocking this denial [of the Sunnah as the second source of authority of Sunni Islam] was to Sunni Muslims at the time (and indeed today)"); See also Francois Burget and William Dowell, *The Islamic Movement in North Africa*, Center for Middle Eastern Studies, University of Texas, Austin, 1983, generally Chapter 8.

<sup>52</sup> *Ibid.*, p. 115-116.

<sup>53</sup> Silverstein, "How Kadafi Went From Foe to Ally," *Los Angeles Times*; See also Camille Tawil, *Brothers in Arms: The Story of al-Qa'ida and the Arab Jihadists* (Saqi Books, London, 2011), p. 33 ("Those who escaped the mass arrests did not wait for further evidence that the time was not yet ripe for their jihad; instead, they packed their bags and followed their Arab brothers to Afghanistan.").

<sup>54</sup> Pargeter, *Libya: The Rise and Fall of Qaddafi*, p. 113-117; Tawil, *Brothers in Arms*, p. 33.

<sup>55</sup> Silverstein, "How Kadafi Went from Foe to Ally," *Los Angeles Times*.

Even fleeing the country did not mean escaping Gaddafi's reach. In the 1970s and 80s, Gaddafi's government reportedly formed assassination squads that tracked down and killed his opponents abroad.<sup>56</sup>

## Flight from Libya

State restrictions on the practice of Islam were the main reason most of the men interviewed for this report said they had left Libya, though some also cited more general freedom of expression issues. "I had a beard when I was at the university and it was obvious I used to pray," said Mustafa Salim Ali el-Madaghi, one of the men who fled Libya in 1990 only to be sent back by foreign governments. "I was afraid to show anything like that because such an appearance was considered an act of outright opposition. I started to be followed by a security person.... All of this plus the continuous arrests of people made me decide to leave Libya because I knew that if I stayed I would end up in prison."<sup>57</sup> Another former detainee, Abu Farsan, said he prayed at home and avoided the mosque because "going to the mosque was the route to prison."<sup>58</sup>

Those interviewed said that after they had left the country, a number of friends and relatives who stayed behind were harassed, detained, or killed.<sup>59</sup> After he fled Libya in 1988, Sami al-Saadi said that security forces repeatedly harassed his elderly father, even breaking into his house and beating him. Two of Saadi's brothers were also arrested and imprisoned in Tripoli's high security prison, Abu Salim, where many political prisoners were held. After being held for several years without trial, both lost their lives in the 1996

---

<sup>56</sup> Pargeter, *Libya: The Rise and Fall of Qaddafi*, p. 103-105 (On one occasion, Musa Kusa, Gaddafi's former Intelligence Chief, reportedly admitted to these killings, reportedly telling *The Times* "on 11 June 1980: 'We killed two in London and there were another two to be killed... I approve of this.'" On another occasion the attacker of a Libyan man killed in Rome reportedly told the police that he was sent by people to kill the victim because he was a "traitor" and an "enemy of the people."); See also these two *Associated Press* stories, one in the *Schenectady Gazette* and another in the *Gainesville Sun* reporting on May 18, 1984 that the Gaddafi government had taken a decision, according to *JANA*, the official Libyan news agency, to form squads to hunt down "traitors, fugitives and stray dogs," wherever they are, and "liquidate" them without "any hesitation": "Libya Forms Suicide Squads to kill 'Traitors, Fugitives, and Stray Dogs,'" *Schenectady Gazette*, May 18, 1984, [bit.ly/RK9UV2](http://bit.ly/RK9UV2) (accessed August 18, 2012); and "Libyan Suicide Squads to Chase, 'Traitors,'" *Gainesville Gazette*, May 18, 1984, <http://bit.ly/Sx6lkN> (accessed August 19, 2012); See also Hilsum, *Sandstorm*, p. 79-83.

<sup>57</sup> Human Rights Watch interview with Mustafa Salim Ali el-Madaghi (Madaghi), Tripoli, Libya, March 26, 2012.

<sup>58</sup> Human Rights Watch interview with Abu Farsan, March 26, 2012.

<sup>59</sup> See Human Rights Watch, *Truth and Justice Can't Wait: Human Rights Developments in Libya Amid Institutional Obstacles*, 1-56432-563-6, December 2009, <http://www.hrw.org/sites/default/files/reports/libya1209web.pdf> (accessed July 24, 2012), p. 53 ("Many of the prisoners who were killed in 1996 had been imprisoned in Abu Salim since 1989 or 1995, years in which mass arrests took place to crack down on perceived opposition.").

Abu Salim massacre, in which prison guards killed some 1,200 prisoners after a revolt over prison conditions.<sup>60</sup>

All of the men interviewed for this report were in their late teens or early twenties when they left Libya. Some of them were founding members of the Libyan Islamic Fighting Group (LIFG), discussed below. After leaving Libya, most were among a large group of Libyans who went to Afghanistan around this time, where they joined other Libyans there fighting with rebel groups, referred to broadly as “the mujahidin,” against Soviet military forces and the Soviet-backed Afghan government.<sup>61</sup> The United States, Saudi Arabia, Pakistan, and several other governments backed the Afghan rebels with covert funding, weapons, and training for the fighters.<sup>62</sup> The Saudi government for example, contributed \$350 to \$500 million per year for the mujahidin through a US government controlled Swiss bank account.<sup>63</sup> “In Saudi Arabia, everyone was talking about the Afghan Jihad,” said Osmail Omar Gebril al-Lwatty, one of the rendered Libyans who fought in Afghanistan. “They made it so easy for us. There were camps where you could live normally and train, in Jalalabad and Khost, then you went to Peshawar to get equipped.”<sup>64</sup>

A well-known Palestinian cleric at the time, Abdullah Azzam, authored numerous statements and texts, one of which was published as a book, considered by many to constitute a fatwa (legal pronouncement), in which he argued that Muslims had a personal obligation to defend Afghanistan against the Soviets.<sup>65</sup> “I believed the people in Afghanistan were

---

<sup>60</sup> Human Rights Watch interview with Saadi, March 14, 2012; See also Tawil, *Brothers in Arms*, p. 181, n. 1 and these reports for more information about the Abu Salim killings: Human Rights Watch, “Libya: June 1996 Killings at Abu Salim Prison,” June 28, 2006, <http://www.hrw.org/sites/default/files/reports/libya2003.pdf>; and Human Rights Watch, “Libya: Truth and Justice Can’t Wait,” Dec. 12, 2009, <http://www.hrw.org/sites/default/files/reports/libya1209web.pdf>, p. 46.

<sup>61</sup> Noman Benotman, a former member of the Shura Council of the LIFG, estimated in one account that there were between 800 and 1,000 Libyan fighters of various affiliations in Afghanistan. See Tawil, *Brothers in Arms*, p. 165, n. 38. In another account, Benotman estimated between 900 and 1,000. See Omar Ashour, “Post-Jihadism: Libya and the Global Transformations of Armed Islamist Movements,” *Terrorism and Political Violence*, Vol. 23, Issue 3 (2011), p. 382. Although Gaddafi supported Islamist rebel groups in other countries—the Philippines for instance—he did not throw his support behind Afghan rebel groups because of Libya’s then close relationship with the Soviet Union.

<sup>62</sup> Lawrence Wright, *The Looming Tower: Al-Qaeda and the Road to 9/11* (New York: Vintage Books, 2006), p. 119; Ahmed Rashid, *Taliban: Militant Islam, Oil and Fundamentalism in Central Asia* (New Haven: Yale University Press, 2000), p. 197. Steve Coll, *Ghost Wars: The Secret History of the CIA, Afghanistan, and Bin Laden, From the Soviet Invasion to September 10, 2001* (New York: Penguin Books, 2004), p. 65; Ali Soufan, *The Black Banners: The Inside Story of 9/11 and the War Against al-Qaeda* (New York and London: W. W. Norton & Company, 2011), p. 22.

<sup>63</sup> Wright, *The Looming Tower*, p. 119.

<sup>64</sup> Human Rights Watch interview with Lwatty, March 17, 2012 .

<sup>65</sup> Wright, *The Looming Tower*, p. 117-18; See also Tawil, *Brothers in Arms*, p. 17; and Soufan, *The Black Banners*, p. 23.

oppressed,” said Sami al-Saadi, when explaining to Human Rights Watch what took him to Afghanistan.”<sup>66</sup> He added that the Libyans who went also viewed their time in Afghanistan as a way to obtain military training that they could eventually use to overthrow Gaddafi.

## Libyan Islamic Fighting Group

The date the Libyan Islamic Fighting Group (LIFG) was founded is unclear. According to some senior members, the LIFG grew out of a secret group that was formed in Libya in the late 1980s out of frustration with Gaddafi’s rule and his crackdown on organized Islamist opposition.<sup>67</sup> Some scholars, however, assert that the group formed in Afghanistan in the 1990s.<sup>68</sup> “So many people think that we established our organization in Afghanistan and that it was due to the ideas in Afghanistan, but we started here in Libya in 1988,” said Mohammed al-Shoroeiya, who was the LIFG’s Deputy Head of the Military Council.<sup>69</sup> “We had one goal, getting rid of the Gaddafi regime.” In any case, the LIFG appears to have become a more organized and larger entity in Afghanistan during the 1990s.<sup>70</sup>

After the Soviets withdrew from Afghanistan in 1989, a struggle to remove the Soviet-backed proxy government of Mohammed Najibullah continued through the early 1990s. Infighting among many Afghan factions ensued and intensified, with many areas in Afghanistan, including Kabul, engulfed in civil war.<sup>71</sup> The fighting made it difficult for many Libyans to remain in Afghanistan. The LIFG began covertly sending operatives into Libya, staging operations against the government.<sup>72</sup> It also set up bases in Pakistan and Sudan, as well as in Europe and the Middle East. From 1995 until 1998, the LIFG waged a low-level

---

<sup>66</sup> Human Rights Watch interview with Saadi, March 14, 2012.

<sup>67</sup> Human Rights Watch interviews with Shoroeiya, March 18, 2012; and Sharif, March 14, 2012; See also Tawil, *Brothers in Arms*, p. 51-52.

<sup>68</sup> Hilsum, *Sandstorm*, p. 91-92.

<sup>69</sup> Human Rights Watch interview with Shoroeiya, March 18, 2012.

<sup>70</sup> There are several estimates that by April 1992 there were between 800 and 1,000 Libyans fighting with the mujahidin in Afghanistan. See Tawil, *Brothers in Arms*, p. 64, n.1; Ashour, “Post-Jihadism: Libya and the Global Transformations of Armed Islamist Movements,” p. 382.

<sup>71</sup> Human Rights Watch, *Afghanistan—Blood-Stained Hands: Past Atrocities in Kabul and Afghanistan’s Legacy of Impunity*, July 7, 2005, <http://www.hrw.org/reports/2005/07/06/blood-stained-hands-o>.

<sup>72</sup> Omar Ashour, “Libyan Islamists Unpacked: Rise, Transformation, and Future, May 2012,” Brookings Doha Center <http://www.brookings.edu/~media/research/files/papers/2012/5/02%20libya%20ashour/omar%20ashour%20policy%20briefing%20english.pdf> (accessed July 31, 2012), p. 2; See also Hilsum, *Sandstorm*, 91-95; and Pargeter, *Libya: The Rise and Fall of Qaddafi*, p. 168.



insurgency, mainly in eastern Libya, intended to overthrow Gaddafi militarily. It staged three unsuccessful attempts to assassinate Gaddafi between 1995 and 1996.<sup>73</sup>

The LIFG did not formally announce its existence until Libyan authorities discovered it in June 1995, after a clash over the rescue of an LIFG member who was under armed guard in a hospital.<sup>74</sup> This clash forced the LIFG into the open and was the start of several serious battles between the LIFG and the Libyan government for the next three years. This included large-scale aerial bombardment of the LIFG's strongholds in eastern Libya.<sup>75</sup> By 1998, the government succeeded in crushing the group's Libyan operations, and many of its members fled. Some sought asylum in the United Kingdom and elsewhere in Europe, but a large number of them returned to Afghanistan, one of the only locations where, according to many of those interviewed for this report, Libyans who did not have proper papers or documentation were able to remain.<sup>76</sup> "At the time there was no other country that allowed us to be together and train," said Muhammad Abu Farsan, an LIFG member who had fled Libya in 1990.<sup>77</sup> Many were also drawn to the Taliban's concept of an Islamic state.<sup>78</sup> At the time, many others from the region, such as Morocco and Algeria, who sought to overthrow their governments for being insufficiently Islamic, also went to Afghanistan.<sup>79</sup> Al Qaeda tried to use these groups and their members to further its own aims but most of them reportedly resented these efforts.<sup>80</sup>

"The regime was like an upside down pyramid built upon the personality of Gaddafi. Get rid of Gaddafi and everything changes," Shoroeyia said. "That was our goal.... We didn't anticipate that other groups [in Afghanistan] would have ideas to fight against others in this world."

---

<sup>73</sup> Ashour, "Libyan Islamists Unpacked," p. 2.

<sup>74</sup> Tawil, *Brothers in Arms*, p. 64-66; Ashour, "Libyan Islamists Unpacked," p. 2; Hilsum, *Sandstorm*, 93-95.

<sup>75</sup> Tawil, *Brothers in Arms*, p. 139.

<sup>76</sup> See also *Ibid.*, p. 179.

<sup>77</sup> Human Rights Watch interview with Abu Farsan, March 26, 2012.

<sup>78</sup> *Ibid.*

<sup>79</sup> Ali Soufan, *The Black Banners: The Inside Story of 9/11 and the War Against al-Qaeda* (New York and London: W. W. Norton & Company, 2011), p. 131.

<sup>80</sup> Soufan, *The Black Banners*, p. 131.

Some senior members of the LIFG said that al Qaeda tried to persuade the LIFG on several occasions in 2000 and 2001 to form an alliance with them, but that the LIFG refused.<sup>81</sup> At the time, the LIFG was the largest Arab armed group in Afghanistan besides al Qaeda.<sup>82</sup> In meetings in Kandahar, Afghanistan, in April and May 2000, both Sami al-Saadi and Noman Benotman, senior LIFG members, said the LIFG demanded that bin Laden cease using Afghanistan as a base from which to launch operations.<sup>83</sup> After the September 11, 2001 attacks, most of the core leadership of the LIFG, with some exceptions, fled Afghanistan, sure they would be swept up in post-September 11 arrests and unwilling to stay behind and fight with the Taliban and al Qaeda.<sup>84</sup> Indeed, as is documented in this report, many senior LIFG members were arrested in 2003 and 2004. The biggest blow came in March 2004 when both Belhadj, head of the LIFG, and Sami al-Saadi, the LIFG's religious leader, were taken into custody and sent back to Libya with direct US and UK participation.

Years later, there was speculation that two other longtime LIFG members—one of whom reportedly had been detained by US forces in Bagram, Afghanistan, but escaped, Abu Yahya al-Libi,<sup>85</sup> and another who remained behind in Afghanistan after the September 11 attacks, Abu Layth al-Libi<sup>86</sup>—had joined al Qaeda.<sup>87</sup>

---

<sup>81</sup> Tawil, *Brothers in Arms*, p. 153 (According to Noman Benotman, former senior LIFG member, on one of these occasions “[Bin Laden’s] plan to create the World Islamic Front for Jihad against Jews and Crusaders was put to us, just as it was to all other jihadist groups.... We rejected the proposals of our own free will, saying that the plan was incompatible with our own strategy and doomed to failure.”); See also Christophe Ayad, “‘We Are Simply Muslim’: Libyan Rebel Chief Denies Al-Qaeda Ties,” *Le Monde*, translated into English and published by *Time.com*, September 4, 2011, <http://www.time.com/time/world/article/0,8599,2091744,00.html> (accessed May 2, 2012) (where LIFG head Abdul Hakim Belhadj says, “when Osama Bin Laden founded the Global Islamic Front to fight against the Jews and crusaders, in the autumn of 1998, we refused to become members of it. How could we want to kill all Christians? Or all Jews? That’s absurd! And why not the Chinese or Japanese? Christians and Jews are the people of the Book, we have to protect them.”); See also Tawil, *Brothers in Arms*, p. 179-180 (“Merging with another group would have meant the LIFG losing its freedom to operate independently in Libya: it was an idea that we rejected from the outset,” Benotman said); During an interview with Human Rights Watch in Tripoli on March 14, 2012, a LIFG religious leader echoed the same sentiments as Benotman and Belhadj about this offer to join bin Laden’s organization.

<sup>82</sup> Tawil, *Brothers in Arms*, p. 170.

<sup>83</sup> *Ibid.*, p. 167-68 (“[O]f all the groups, the LIFG was the most outspoken. I myself called on bin Laden to stop, in the presence of Abu al-Mundhir al-Sa’idi, among others. Our argument was that attacking the US from Afghanistan would undermine the Taliban state and bring it under unbearable [international] pressure. We said all this to bin Laden’s face in Kandahar.”).

<sup>84</sup> Tawil, *Brothers in Arms*, p. 180; Human Rights Watch interview with Saadi, March 14, 2012.

<sup>85</sup> “...Abu Yahya al-Libi, was detained following the US invasion of Afghanistan. In July 2005 he escaped from Bagram Air Base, north of Kabul, with three other high-profile detainees. He subsequently appeared in video recordings threatening the United States with humiliation by the mujahidin.” Tawil, *Brothers in Arms*, p. 180, n2 and p. 196.

<sup>86</sup> “In 1996 Abu Layth al-Libi escaped with two other LIFG members from the al-Ruways Prison in Jeddah. They had been arrested in connection with a 1995 car bomb attack against a US-run training center for the Saudi National Guard in Riyadh.” Tawil, *Brothers in Arms*, p. 196, no. 1.

In late autumn of 2007, these reports appeared to be confirmed when Abu Layth al-Libi announced that the LIFG had joined al Qaeda.<sup>88</sup> This assertion, however, was later rejected by core leaders of the LIFG, which posted statements on several websites saying it was unauthorized. The LIFG “had no link to the al Qaeda organisation in the past and has none now,” the statement read.<sup>89</sup>

In fact, by the time Abu Layth made the announcement, the core leadership of the LIFG, then imprisoned in Libya, had already begun reconciliation talks with the Gaddafi government.<sup>90</sup> The mediator for these talks was Saif al-Islam, one of Gaddafi’s sons.<sup>91</sup> Noman Benotman, a LIFG member based in the UK, was allowed to return to Libya for the talks.<sup>92</sup> Abu Layth al-Libi and Abu Yahya al-Libi reportedly opposed reconciliation.<sup>93</sup> In January 2008, Abu Layth was reportedly killed in a US air strike.<sup>94</sup>

Ultimately the LIFG leadership imprisoned in Libya did reconcile with the Libyan government. Part of that reconciliation involved the publishing of a book, over 400 pages long, called “Corrective Studies in Understanding Jihad Accountability and the Judgment of the People,” in which the LIFG renounced the use of violence to achieve political aims.<sup>95</sup> The book was authored by six of the LIFG’s most senior members: Belhadj, Saadi, Sharif, Abd al-Wahhab (the elder brother of Abu Yahya al-Libi), Mitfah al-Duwdi, and Mustafa Qanaifid. It ultimately resulted in the early release in March 2010 of three of the men interviewed for this report—Belhadj, Sharif and Saadi—along with hundreds of other prisoners.<sup>96</sup>

---

<sup>87</sup> Ibid., p.180, 196.

<sup>88</sup> Ibid., p. 196.

<sup>89</sup> David Blair, “Extremist group announces split from al-Qaeda,” *The Daily Telegraph*, July 9, 2009, <http://bit.ly/mUx5al>, (accessed May 15, 2012).

<sup>90</sup> Tawil, *Brothers in Arms*, p. 196-97.

<sup>91</sup> Ibid., p. 196, n. 3.

<sup>92</sup> Ibid., p. 197.

<sup>93</sup> Ibid.

<sup>94</sup> Ibid.; See also Blair, “Extremist group announces split from al-Qaeda,” *The Daily Telegraph*.

<sup>95</sup> Camille Tawil, “The Libyan Islamic Fighting Group’s revisions: one year later,” *Magharebia*, July 23, 2010, [http://magharebia.com/cocoon/awi/xhtml1/en\\_GB/features/awi/features/2010/07/23/feature-02](http://magharebia.com/cocoon/awi/xhtml1/en_GB/features/awi/features/2010/07/23/feature-02) (accessed June 19, 2012); See also a text of selected translations of “Corrective Studies in Understanding Jihad, Accountability and the Judgment of People,” in Mohammed Ali Musawi, “Selected Translation of the LIFG Recantation Document,” Quilliam, 2009, <http://www.solami.com/jihadstudy.pdf> (accessed June 19, 2012).

<sup>96</sup> Tawil, “The Libyan Islamic Fighting Group’s revisions: one year later,” *Magharebia*,

Clearly some prominent LIFG members did sympathize with and even joined al Qaeda, but the announced merger did not occur until years after the LIFG's core leadership were detained, with US and UK help, and locked up in Libyan prisons. All of the former LIFG members interviewed for this report said that the LIFG never shared the ideology of al Qaeda or any of its goals. "It happened that we found ourselves in the same place at the same time as al Qaeda: in Afghanistan, where we sometimes fought next to them when it was to liberate the country, but we were never at their service," said Belhadj, the head of the LIFG who would play a leading role in the resistance that overthrew Gaddafi in 2011. "There was no other place [besides Afghanistan] for us to go," said Saadi, the LIFG's religion and legal expert. He said that al Qaeda asked the LIFG to join them, as other jihadist groups had, but that the LIFG refused. "Our purpose, the object of our fight, was the Gaddafi regime and we did not want to open any conflicts up with Western governments or with anyone besides the Gaddafi regime," he said.<sup>97</sup>

The US government took a different view. After September 11, 2001, Gaddafi condemned the attacks against the United States, said the US government had the right to retaliate, and urged Libyans to donate blood to victims. He later said that the United States and Libya had a common interest in fighting terrorism.<sup>98</sup> Shortly thereafter, on September 25, 2001, President George W. Bush signed an executive order freezing the assets of the LIFG in the United States.<sup>99</sup> One month later, senior administration officials went to Tripoli to meet with Musa Kusa, who handed over information on Libyans who he claimed were allied with al Qaeda, as well as the names of several Libyan militants living in the United Kingdom.<sup>100</sup> And in December 2004, after the United States and the United Kingdom had

---

<sup>97</sup> Human Rights Watch interview with Saadi, March 14, 2012. Saadi, who was the LIFG's spiritual leader, said he met personally with Osama bin Laden on two occasions before September 11, 2001 to tell him that al Qaeda's views about killing civilians violated Sharia law and his anti-US activities would be damaging to Islam. Another former LIFG leader, Noman Benotman, said he also travelled to Afghanistan in 2000 to personally tell bin Laden to stop his operations against the US. Paul Cruickshank, "How Muslim extremists are turning on Osama bin Laden," *Daily News*, June 8, 2008, [http://articles.nydailynews.com/2008-06-08/news/17899919\\_1\\_libyan-islamic-fighting-group-al-qaeda-laden](http://articles.nydailynews.com/2008-06-08/news/17899919_1_libyan-islamic-fighting-group-al-qaeda-laden) (accessed June 10, 2012); See also Tawil, *Brothers in Arms*, p. 13 ("Of all the jihadist factions, the LIFG was most outspoken in rejecting bin Laden's anti-American manifesto. Like other jihadists, the LIFG's leaders had emigrated [sic] to Afghanistan but remained committed to combating the Libyan regime.").

<sup>98</sup> Silverstein, "How Kadafi Went from Foe to Ally," *Los Angeles Times*.

<sup>99</sup> John C.K. Daly, "Libya and al-Qaeda: A Complex Relationship," The Jamestown Foundation, *Terrorism Monitor*, Vol. 3, Issue 6, March 23, 2005, [http://www.jamestown.org/programs/gta/single/?tx\\_ttnews%5Btt\\_news%5D=30146&tx\\_ttnews%5BbackPid%5D=180&no\\_cache=1](http://www.jamestown.org/programs/gta/single/?tx_ttnews%5Btt_news%5D=30146&tx_ttnews%5BbackPid%5D=180&no_cache=1) (accessed August 23, 2012).

<sup>100</sup> *Ibid.*; See also Human Rights Watch, *Words to Deeds*, p. 18.

reconciled with Gaddafi and a number of LIFG leaders had been sent back to Libya, the US State Department placed the LIFG on its list of terrorist groups.<sup>101</sup> Later the State Department elevated the LIFG to an al Qaeda “affiliate.”<sup>102</sup>

## Gaddafi’s Rapprochement with the West

Gaddafi’s willingness to provide intelligence about Islamist armed groups, and his agreement to give up Libya’s “weapons of mass destruction” program, appear to have been key to the thawing of relations between Libya and Western governments.<sup>103</sup> Some correspondence in the Tripoli Documents reflects this new relationship.<sup>104</sup> In September 2003, Gaddafi also agreed to pay compensation to family members of those killed in the bombing of Pan Am Flight 103 over Lockerbie, Scotland in 1988; in return, international sanctions against Libya would be lifted.<sup>105</sup> In February 2004 the United States opened a diplomatic mission in Tripoli and, in June 2006, the US State Department rescinded Libya’s designation as a state sponsor of terrorism.<sup>106</sup> The Tripoli Documents also show that at some point in March 2004, the CIA began to set up an office in Libya.<sup>107</sup>

On March 25, 2004, UK Prime Minister Tony Blair paid a visit to Libya, the first by a British prime minister since 1943. He and Gaddafi formally mended relations between the two countries and discussed their “common cause” in counterterrorism operations.<sup>108</sup> On the

---

<sup>101</sup> Human Rights Watch, *Words to Deeds*, p. 18; See also Daly, “Libya and al-Qaeda: A Complex Relationship,” *Terrorism Monitor*; and US Department of State, “Foreign Terrorist Organizations,” <http://www.state.gov/documents/organization/65479.pdf> (accessed August 29, 2012), p. 210.

<sup>102</sup> Human Rights Watch, *Words to Deeds*, p. 18

<sup>103</sup> See Tripoli Documents 2164-2165. See also Silverstein, “How Kadafi Went From Foe to Ally,” *Los Angeles Times*; and Sharon A. Squassoni and Andrew Feickert, “Disarming Libya: Weapons of Mass Destruction,” *Congressional Research Service*, April 22, 2004, <http://fpc.state.gov/documents/organization/32007.pdf> (accessed May 20, 2012).

<sup>104</sup> See Tripoli Documents 2165, 2169, 2173, 2226, 2252, 2266-2267.

<sup>105</sup> UN Security Council Resolution No. 1506 (2003), S/RES/1506 (2003), <http://www.unhcr.org/refworld/country,LEGAL,,RESOLUTION,LBY,,3f8d2e164,o.html> (accessed June 13, 2012). Libya agreed to pay the families of victims \$10 million each—\$4 million after the lifting of UN sanctions, another \$4 million after the lifting of US sanctions based on the International Emergency Economic Powers Act, and the last \$2 million when the US State Department took Libya off its list of states sponsoring terrorism.

<sup>106</sup> US Department of State, Bureau of Near Eastern Affairs, “Background Note: Libya,” March 9, 2012, <http://www.state.gov/outofdate/bgn/libya/196690.htm> (accessed June 11, 2012).

<sup>107</sup> Tripoli Document 2169.

<sup>108</sup> “Blair hails new Libyan relations,” BBC News, March 25, 2004, [http://news.bbc.co.uk/2/hi/uk\\_news/politics/3566545.stm](http://news.bbc.co.uk/2/hi/uk_news/politics/3566545.stm), (accessed June 17, 2012).

“I informed them that I faced a real danger if they sent me back. I was wanted in Libya.... If I reached Gaddafi that was when the real ‘ceremony’ was going to begin. I was so clear. I said they will kill me, they will torture me.... It was the first time I cried actually, the first tears I wept were when they told me I was being handed over to the Libyans.”

same day, Anglo-Dutch oil giant Shell announced it had signed a deal worth up to £550 million (approximately \$1 billion US) for gas exploration rights off the Libyan coast.<sup>109</sup>

Gaddafi’s rapprochement with the West had profound effects on the LIFG. After the United States added the LIFG to its official list of foreign terrorist organizations, the United Kingdom followed suit in October 2005.<sup>110</sup> As one prominent LIFG member, Noman Benotman, said at the time, “Now anyone who is an enemy of Kadafi is also an enemy of the United States.”<sup>111</sup>

After the September 11 attacks and the US-led invasion of Afghanistan in October 2001, the Libyans who had been training with the LIFG in Afghanistan—as well as many other armed groups that had established a foothold in Afghanistan—broke apart and fled. Many of the Libyans initially went to Pakistan and then on to Asia, Africa, and elsewhere in the Middle East. Those who spoke to Human Rights Watch said that they constantly feared apprehension and that their worst fear was being captured and returned to Libya. Mustafa Jawda al-Mehdi said he begged his American captors not to send him back:

I informed them that I faced a real danger if they sent me back. I was wanted in Libya.... If I reached Gaddafi that was when the real ‘ceremony’ was going to begin. I was so clear. I said they will kill me, they will torture me.... It was the first time I cried actually, the first tears I wept were when they told me I was being handed over to the Libyans.

---

<sup>109</sup> Ibid.

<sup>110</sup> “‘Terror group’ ban agreed by MPs,” BBC News, October 13, 2005, <http://news.bbc.co.uk/2/hi/4327964.stm> (accessed June 13, 2012).

<sup>111</sup> Silverstein, “How Kadafi Went From Foe to Ally,” *Los Angeles Times*.

**PLACES OF ARREST, DATES OF TRANSFER, AND TIME IN US SECRET DETENTION IN AFGHANISTAN OF FIVE LIBYANS HELD IN US CUSTODY**

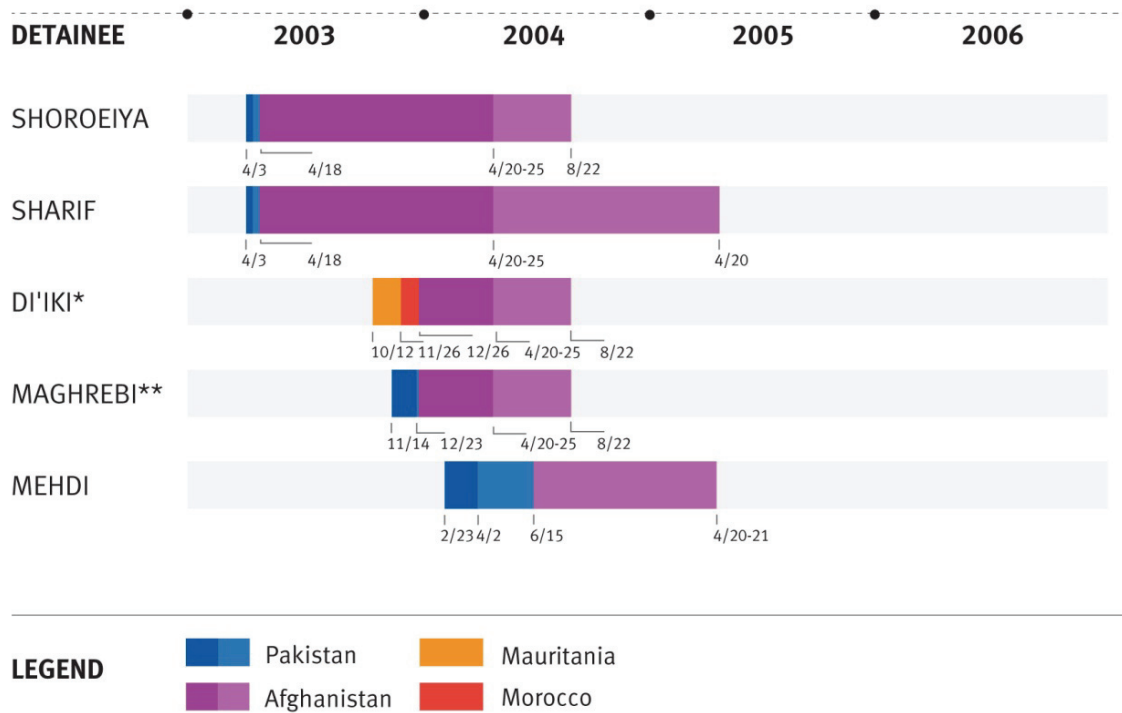

The dates in the table are approximations based on the accounts of the five Libyans as well as corroborating information from other detainees thought to be held in the same location. For example, the transfer between the different Afghan facilities is believed to have been around April 25, 2004, but that may not be the exact date for each detainee.

\*) The dates for Di'iki are estimates. He said he was arrested on October 12, 2003, detained in the first location in Mauritania for about two to three weeks, and then in the second place for about two weeks. That would have occurred around November 12-19, 2003. He said he was then sent to Morocco, where he was held for about one month.

That took place around December 8-15, 2003. He said he was then transferred to Afghanistan in early January 2004; he thought it was around January 7, 2004. If that is correct, it would mean he was in detention either in Mauritania or Morocco for longer than he thinks, or he is mistaken about the date of transfer to Afghanistan. In either case, he said he was forcibly returned from a second facility in Afghanistan to Libya on August 22, 2004.

\*\*\*) The dates for the time Maghrebi was in the first and second location in Afghanistan are estimates. He said that in the first location he was in his first cell for about two months, then another cell for about 15 days and then a third cell for another one and a half to two months. This would put him in the first cell until around February 10, 2004, the second cell until March 10, 2004, and the third cell until sometime between March 10 and April 25, 2004. Several other detainees said they were transferred around April 25, 2004 to a second location and Maghrebi said he was with about six other people during his transfer, so we believe that he was moved to the second location on that same date. The April 25 date is consistent with his assertion that he was held in the second facility for about four months and was returned to Libya on August 22, 2004 with Shoroeiya and Di'iki.

## II. Detainee Accounts from Afghanistan and Morocco

This section focuses on six individual cases involving detentions in Afghanistan or Morocco and subsequent transfers to Libya. We have grouped them together because, of the 14 individuals interviewed by Human Rights Watch, these are the ones whose unlawful renditions to Libya were most clearly connected to the United States. They also are the ones who spent the longest period of time in US custody, and experienced the most serious abuse. Five of them reported being held in US-run prisons in Afghanistan for between eight months and two years before being transferred to Libya. Four of the five were detained in Pakistan before being transferred to Afghanistan and one was detained in Morocco before being sent to Afghanistan. A sixth individual, connected to the latter by a communication in the Tripoli Documents,<sup>112</sup> was also held in Morocco. Unlike the others, he was not sent to Afghanistan but rather straight to Libya from Morocco.

### Mohammed Ahmed Mohammed al-Shoroeiya and Khalid al-Sharif

Mohammed al-Shoroeiya (Shoroeiya)<sup>113</sup> and Khalid al-Sharif (Sharif)<sup>114</sup> are two former LIFG members who said they left Libya in 1991 and 1988 respectively. Pakistani authorities arrested the two together in Peshawar, Pakistan, in April 2003. Pakistani and US personnel interrogated and then transferred them to US-run detention facilities in Afghanistan. While they were physically abused during interrogations in Pakistan, they said the mistreatment in Afghanistan was much worse.

---

<sup>112</sup> Tripoli Documents 2141-2142.

<sup>113</sup> Shoroeiya's name has also been spelled "Mohammed Ahmed el Shoro'eyya," and he has also gone by the name "Hassan Rabi'i" (also spelled "Rabii" or "Riba'i"). The transliteration of Arabic names into the Roman alphabet follows no standard guidelines. With full Arabic names often consisting of up to five parts, a name may commonly be translated to many different spellings; for example, four different spellings are commonly used for the English version of the name Muhammad. The varied spellings of a single individual's name have led to difficulty in identifying persons detained by the US, who may be documented under several forms of their name. Individuals who were detained together may also only be able to identify others by an alias, nickname, or mixed version of another detainee's name.

<sup>114</sup> Khalid al-Sharif's name has also been spelled "Khaled Sherif," "Khalid el-Sharif," and "Khaled el-Sherif." He has also gone by the names of "Abu Hazem" (also spelled "Hazim"), "Mohammed Daoud," and "Amer."



Shoroeiya and Sharif said that once in Afghanistan, they were detained and interrogated—for more than a year in Shoroeiya’s case, and for two years in Sharif’s case—by US personnel. This included being chained to walls naked—sometimes while diapered—in pitch black, windowless cells, for weeks or months at a time; being restrained in painful stress positions for long periods of time, being forced into cramped spaces; being beaten and slammed into walls; being kept inside for nearly five months without the ability to bathe; being denied food; being denied sleep by continuous, deafeningly loud Western music; and being subjected to different forms of water torture including, in Shoroeiya’s case, waterboarding.



Mohammed al-Shoroeiya. © 2012 Human Rights Watch

Following their US detention, they were rendered to Libya, where they were again abused in detention. Both were eventually summarily tried and convicted, with Shoroeiya sentenced to life in prison and Sharif sentenced to death by firing squad. Sharif was released on March 23, 2010, after nearly five years in prison, as part of a negotiated agreement involving other imprisoned LIFG leaders and hundreds of other prisoners. Shoroeiya was released on February 16, 2011, when the uprisings against Gaddafi began.



Khalid al-Sharif  
© 2012 Human Rights Watch

Human Rights Watch interviewed Shoroeiya and Sharif separately on two different days in March 2012 in Tripoli and then again by phone from New York in May 2012. Human Rights Watch also spoke to Shoroeiya in Abu Salim Prison in Tripoli in April 2009. The men have been in contact with one another since their release from Libyan custody.

### *Departure from Libya*

Sharif was born in 1965 in Tripoli and left Libya in April 1988 when he was 23 because “the situation was getting worse,” he said. “Our religious people were subjected to abuse. We had no ability to express ourselves, no choices. Even attending the mosque was a crime.” He had been studying pharmacology at college in Tripoli. He and some others started a secret group to try and overthrow the government, but one of his friends was executed. After that, he and others in the group decided to leave Libya, out of fear, but also to organize and train. Sharif left Libya for Saudi Arabia, then Pakistan and Afghanistan. He became very active in the LIFG, eventually becoming the deputy head of the organization. In 1995 he moved to Sudan, where he said the LIFG started to take some action against the Libyan government. He said he was forced to leave Sudan in 1996 and went to Turkey, then back to Pakistan, where he lived until 2002. After the September 11 attacks, he and his family went to Iran, but in Iran he was detained and forced to return to Pakistan. He arrived back in Pakistan in early 2003.<sup>115</sup>

Shoroeiya is from Misrata in eastern Libya. He was born on March 22, 1969 and left Libya in 1991. He was in the middle of his studies in science but left, he said, because of threats against committed Muslims, especially those who were students. He first went to Algeria and then to join other members of the LIFG in Pakistan and Afghanistan. In 1995 he moved to Sudan, where the LIFG was based and planning actions against the Gaddafi government. The actions drew new recruits, he said, but the Sudanese government would not allow the LIFG to train the recruits, so they moved back to Afghanistan. He left Afghanistan for Turkey in 1999 and married an Algerian woman, Fawziya, while there. They returned to Afghanistan in 2000 and were in Kabul during the September 11 attacks, though they quickly moved to Karachi, Pakistan. He said that for him this was a very frightening time and that the LIFG did not agree with bin Laden’s actions. He told Human Rights Watch, “[f]or us there were huge differences between us [al Qaeda and the LIFG], but we knew that they were going to see us all as one group together. At that time, the US lost its ability to distinguish between people.” He began to feel that Karachi was not safe, so he moved to Peshawar. He wanted to try and get to Iran as other LIFG members had done, but his wife was pregnant so his ability to travel was limited.<sup>116</sup>

---

<sup>115</sup> Human Rights Watch interview with Sharif, Tripoli, Libya, March 14, 2012.

<sup>116</sup> Human Rights Watch interview with Shoroeiya, March 18, 2012.

### *Arrest and Detention*

Shoroeiya and Sharif were both arrested in Peshawar on April 3, 2003. Shoroeiya was living with his wife, Fawziya, and their 9-month-old daughter, Aisha. Sharif was staying on the second floor of Shoroeiya's home.<sup>117</sup> Around noon, the house was suddenly surrounded by what seemed to both of them like scores of police, some in vans with black windows.<sup>118</sup> Sharif tried to escape by jumping out the window and climbing over a wall next door. In the process he broke his foot.<sup>119</sup> Shoroeiya was also injured during the arrest, breaking his leg.<sup>120</sup> Shoroeiya was detained for about ten days in a place he referred to as "Khyber." Sharif said he was detained for about seven days in a building called the "army stadium" near a fair-ground. Both places were in Peshawar, but it is not clear if these were the same locations.

Both men were then moved to a facility in Islamabad, Pakistan's capital. Sharif and Shoroeiya said they were in cells next to each other while in Islamabad.<sup>121</sup> Sharif said he knew he was in Islamabad because he had been living in Pakistan by then for many years and knew Islamabad well. He was not blindfolded, and on the second day of his arrival he was brought to a hospital in Islamabad to treat his broken foot.<sup>122</sup>

During this period both say they were interrogated by Pakistani and US personnel. Shoroeiya said there were two teams of Americans, one in Peshawar and one in Islamabad, all men. Sometimes he was hooded during interrogations, but not always. The Pakistanis at times beat him during these interrogations, in some cases after the Americans ordered them to do so. Whenever he was beaten, however, the Americans would leave the room.

Sharif provided additional details of his arrest and detention in Pakistan, including his reasons for believing his captors and interrogators were Pakistani and American. After the arrest, he was immediately blindfolded and hooded. The interrogation began on the same day as the arrest, right after he was taken to the detention facility in Peshawar. He said he believed it was a Pakistani Inter-Services Intelligence (ISI) facility because during his

---

<sup>117</sup> Human Rights Watch interview with Shoroeiya, March 18, 2012.

<sup>118</sup> Human Rights Watch interviews with Sharif, March 14, 2012; and Shoroeiya, March 18, 2012.

<sup>119</sup> Human Rights Watch interview with Sharif, March 18, 2012.

<sup>120</sup> Human Rights Watch interview with Shoroeiya, Abu Salim Prison, Tripoli, Libya, April 27, 2009.

<sup>121</sup> Human Rights Watch interviews with Sharif, March 14, 2012; and Shoroeiya, Abu Salim Prison, Tripoli, April 27, 2009.

<sup>122</sup> Human Rights Watch interview with Sharif, March 14, 2012; and telephone interview, May 24, 2012.

detention the guards were wearing Pakistani military uniforms and the officers, who were in civilian clothes, had a file on him.

During his interrogation, Sharif's blindfold and hood were taken off. He said that because of his broken foot he could not walk, and he would be carried into the interrogation room, an American on one side, a Pakistani on the other. He said the American, who spoke Arabic poorly, would ask the questions and when Sharif did not provide an answer they seemed to think was adequate, the Pakistani would step on his broken and untreated foot. The Pakistani officer would also beat Sharif and lash him with a whip all over his body.

Sharif said that while he was detained in Peshawar, a Pakistani officer who spoke to him in Pashto beat him. He spread Sharif's legs apart and kicked him in his groin. The officer also hit Sharif on his head with a whip so violently that he nearly lost consciousness. While the Pakistani was beating him, a different American sat on a chair right in front of him.

On another occasion at the Peshawar facility, the first American asked him in his poor Arabic for help finding Abu Faraj al-Libi (now detained in Guantanamo). He offered millions of dollars as a reward. This questioning session did not involve any physical abuse. Sharif said that during the final few days of his detention he was not interrogated. He was then moved to Islamabad.

Both Shoroeyia and Sharif said they were interrogated by Pakistanis and Americans at the facility in Islamabad. Sharif said that a few hours after he arrived he was told he was going to be transferred to a place where he would be "better able to speak." He said the comment felt like a threat.

## CIA Rendition Transportation Procedures

The accounts of many former detainees subjected to CIA renditions between the years 2002-2005 show standardized treatment during transfer. In most cases, the detainee was stripped of his clothes, photographed naked, and administered a body cavity search (rectal examination). Some detainees described the insertion of a suppository at that time. The detainee was then dressed in a diaper. His ears were plugged, headphones were placed on his head, he was blindfolded or provided black goggles, and his head was wrapped with bandages and adhesive tape. The detainee's arms and legs were shackled and he was put into the transportation vehicle.<sup>123</sup> (Hereinafter "CIA rendition transportation procedures").

The UN Standard Minimum Rules for the Treatment of Prisoners allow the use of instruments of restraint when prisoners are being transferred. However, some instruments may never be used, such as chains or irons, and others, including handcuffs and straitjackets, shall never be applied as a punishment.<sup>124</sup> The transfer of a prisoner also does not permit treatment that would amount to torture or cruel, inhuman, or degrading treatment.<sup>125</sup> While the US was entitled to use constraints as necessary for transporting detainees by plane, some of these methods, particularly when used in conjunction with others, appear intended to punish the detainee or were, at a minimum, degrading.

---

<sup>123</sup> See Glenn L. Carle, *The Interrogator* (New York: Nation Books, 2011), p. 191, n. 2; Amnesty International, *Below the Radar: Secret Flights to Torture and 'Disappearance*, April 5, 2006, AMR 51/051/2006, <http://www.amnesty.org/en/library/info/AMR51/051/2006/en> (accessed July 30, 2012) (describing the experience of three Yemeni detainees—Muhammad Bashmilah, Salah Qaru, and Muhammad al-Assad—while in CIA custody), p. 12; Declaration of Mohammed Farag Ahman Bashmilah in Support of the Plaintiffs' Motion to Dismiss or, in the Alternative, for Summary Judgment (hereinafter "Bashmilah Declaration"), *Mohamed v. Jeppesen Dataplan, Inc.*, 539 F. Supp. 2d 1128 (N.D. Cal. 2008), (subsequently reversed by *Mohamed v. Jeppesen Dataplan, Inc.*, 614 F.3d 1070 (9th Cir. 2010)(cert. denied May 2011)), <http://www.chrgj.org/projects/docs/declarationofbashmilah.pdf> (accessed May 27, 2012), paras. 37-40; Craig S. Smith and Souad Mekhennet, "Algerian Tells of Dark Term in U.S. Hands," July 7, 2006, *New York Times*, [http://www.nytimes.com/2006/07/07/world/africa/07algeria.html?\\_r=1&pagewanted=all](http://www.nytimes.com/2006/07/07/world/africa/07algeria.html?_r=1&pagewanted=all) (accessed July 30, 2012) (describing the treatment of Algerian detainee, Laid Saidi, under CIA custody); International Committee for the Red Cross, "ICRC Report on the treatment of Fourteen 'High Value Detainees' in CIA Custody," February 2007, <http://assets.nybooks.com/media/doc/2010/04/22/icrc-report.pdf> (accessed July 30, 2012), p. 6-7 (describing the common treatment and experience of 14 "high value" detainees under CIA custody); Human Rights Watch, *Ghost Prisoner*, February 2007, <http://www.hrw.org/sites/default/files/reports/uso207webwcover.pdf>, p. 24, (describing the experience of detainee Marwan Jabour); Amnesty International, *A Case to Answer: From Abu Ghraib to Secret CIA custody: The Case of Khaled al-Maqtari*, March 2008, AMR 51/013/2008, <http://www.amnesty.org/en/library/info/AMR51/013/2008/en> (accessed July 30, 2012), p. 12; ACLU of Northern California, "Biography of Plaintiff Ahmed Agiza," [https://www.aclunc.org/cases/active\\_cases/jeppesen/biography\\_of\\_plaintiff\\_ahmed\\_agiza.shtml](https://www.aclunc.org/cases/active_cases/jeppesen/biography_of_plaintiff_ahmed_agiza.shtml) (accessed July 30, 2012); and ACLU, "Witness: Khaled El-Masri-Victim of Extraordinary Rendition," July 14, 2006, <http://www.aclu.org/human-rights/witness-khaled-el-masri-victim-extraordinary-rendition> (accessed July 30, 2012).

<sup>124</sup> Standard Minimum Rules for the Treatment of Prisoners, adopted Aug. 30, 1955, by the First United Nations Congress on the Prevention of Crime and the Treatment of Offenders, U.N. Doc. A/CONF/611, annex I, E.S.C. res. 663C, 24 U.N. ESCOR Supp. (No. 1) at 11, U.N. Doc. E/3048 (1957), amended E.S.C. res. 2076, 62 U.N. ESCOR Supp. (No. 1) at 35, U.N. Doc. E/5988 (1977), rule 33.

<sup>125</sup> International Covenant on Civil and Political Rights (ICCPR), adopted December 16, 1966, G.A. Res. 2200A (XXI), 21 U.N. GAOR Supp. (No. 16) at 52, U.N. Doc. A/6316 (1966), 999 U.N.T.S. 171, entered into force March 23, 1976, art. 7; Convention against Torture and Other Cruel, Inhuman or Degrading Treatment or Punishment (Convention against Torture), adopted December 10, 1984, G.A. res. 39/46, annex, 39 U.N. GAOR Supp. (No. 51) at 197, U.N. Doc. A/39/51 (1984), entered into force June 26, 1987, arts. 1 and 16.

After one week in Islamabad, both said they were stripped, blindfolded, handcuffed, and their legs shackled.<sup>126</sup> Their captors also put ear plugs in their ears and hoods over their heads.<sup>127</sup> Shoroeiya said that they did some additional things to him, but they were things he could not describe to a female Human Rights Watch researcher.<sup>128</sup> Before being stripped, Sharif mentioned that they examined his mouth, ears, and eyes. The two said they were then taken on a vehicle, and then boarded onto a plane.

They flew for about half an hour to a location they believe was inside Afghanistan. Sharif said that after they disembarked, the detainees were thrown into the back of trucks. Sharif believed he was brought to a hangar-type facility near Kabul airport.<sup>129</sup> Shoroeiya also said he was in a hangar-type facility and believed it was in or near Bagram Air Base, which is about 40 kilometers north of Kabul airport.<sup>130</sup> Neither was sure of their locations but both said they knew they were in Afghanistan because of the time it took to fly to the location and the fact that the guards were dressed in traditional Afghan clothing when they first arrived, occasionally spoke to them in Dari (the local Afghan language), and served them Afghan food. Both knew they were detained in the same location because although they never saw each other, occasionally they were able to talk to one another over the loud music that played constantly.<sup>131</sup>

---

<sup>126</sup> Human Rights Watch interviews with Sharif, March 14, 2012; and Shoroeiya, March 18, 2012.

<sup>127</sup> Ibid.

<sup>128</sup> Human Rights Watch interview with Shoroeiya, Abu Salim Prison, Tripoli, April 27, 2009.

<sup>129</sup> Sharif thought this because, despite the constant music, he said he could at times hear airplanes landing and taking off, and they landed somewhere near where the men were detained when they arrived from Islamabad.

<sup>130</sup> Shoroeiya based this determination on rumors he heard about a secret CIA “black site” in Bagram before he was arrested by US and Pakistani authorities in Peshawar; the time it took him to travel to this location from Islamabad; and one non-verbal exchange he had with an Afghan guard. He asked the guard if he was in Bagram and the guard, though he could not speak to Shoroeiya, returned an expression and a smile that Shoroeiya took to mean confirmation of that fact. Shoroeiya’s hypothesis was shared by other prisoners at the facility. Mohamed Farag Ahmad Bashmilah, a former Yemeni detainee who appears to have been held at the same facility and who knew the two Libyans by the aliases they were using at the time (“Hazem” for Sharif and “Raba’i” for Shoroeiya), recalls hearing other prisoners also guessing that the prison was part of Bagram Air Base. Bashmilah’s descriptions of the facility in Afghanistan and of the treatment he received there are strikingly similar to those offered by Shoroeiya, Sharif, and others interviewed for this report. Like Shoroeiya and Sharif, Bashmilah was also later moved to a second facility where he remained until May 5, 2005. See Bashmilah Declaration, <http://www.chrgj.org/projects/docs/declarationofbashmilah.pdf>, (accessed August 27, 2012), para. 84-92.

<sup>131</sup> Human Rights Watch interview with Shoroeiya, March 18, 2012.

Both were detained in this first location in Afghanistan for about a year. Shoroeiya gave the exact dates, stating that he was there from April 18, 2003 to April 25, 2004.<sup>132</sup> Sharif said he was there for about a year from the time he arrived from Islamabad, though he did not know the exact date of his arrival, until sometime between April 20 and April 25, 2004. They were then moved to a second facility that they both also believed was in Afghanistan and run by Americans. Shoroeiya stayed there for about four months and Sharif for approximately one year.

The following is a description of the first facility in Afghanistan, where they allege the worst abuse occurred.

### *Afghanistan I*

Shoroeiya and Sharif each said they were kept in almost total darkness the entire time they were in the first facility in Afghanistan. Their cells, as well as the rooms where they were interrogated, were dark. Guards and interrogators would come to them with flashlights and in some cases strong spotlights they would shine in their eyes. In addition to the darkness, there was loud, Western music blaring constantly.<sup>133</sup> Both said they were denied clothing during the first few months of their detention.

Shoroeiya had a thin mat in his cell, while Sharif said he had a carpet, perhaps a mat, in his cell. Both had a bucket in their cell they were to use as a toilet. The men said that chemicals were in the bucket that, when mixed with their urine and excrement, gave off a terrible stench. Shoroeiya drew a layout of the facility where he was detained and his cell

---

<sup>132</sup> When we asked Shoroeiya to explain how he was able to know the dates he was detained with precision given that he was kept in darkness for much of his confinement, he said he knew the date he was arrested and how long he was detained in different places in Pakistan. He noted that after he had been held for what seemed like a long period of time, he was taken outside for the first time to see sunlight. When this happened, he glanced at his guard's watch and noticed it was September 5, 2003, nearly five months since his detention in Pakistan. Later, his captors put very small lamps in his room and gave them a Quran, a pencil that was flexible so that it could not be used as a weapon, and some papers. When this happened he took the opportunity to make a calendar. The date he started with was September 5, 2003. From then on he kept track of the days with the help of the person in cell 5, someone named Naseem, who he described as "a sort of specialist with time" because he had a birds' nest outside his window so when "a kind of movement started [in the nest] he could tell it was morning." Shoroeiya was fully composed up until that point of the interview, but when a Human Rights Watch researcher commented on the remarkable adaptability of human beings, Shoroeiya became visibly emotional, tried to continue, but then needed to stop for a break in the interview.

<sup>133</sup> Bashmilah also described the same loud, Western music being played throughout his detention. Bashmilah Declaration, para. 64.

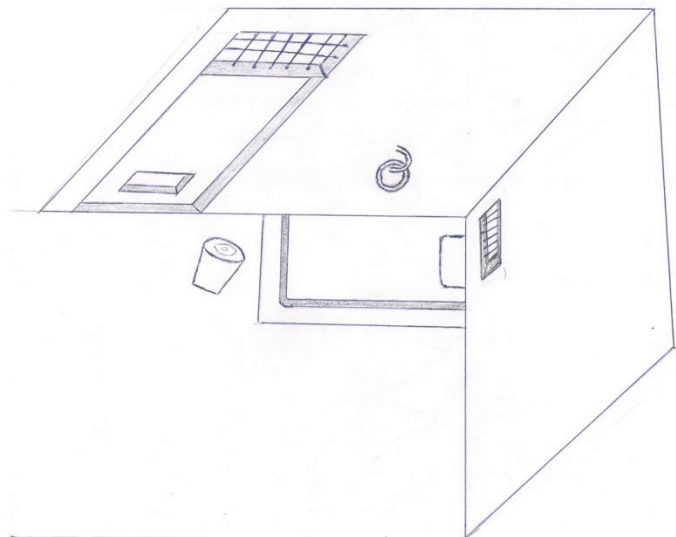

for Human Rights Watch (see below). He was in cell one, which he said was slightly bigger than the rest of the cells. According to Shoroeyia, there were about 15 cells for prisoners in this same location.<sup>134</sup>

A sketch by Mohammed Shoroeyia depicts his cell. © 2012 Mohammed Shoroeyia

Though neither Sharif nor Shoroeyia saw other prisoners, occasionally they were able to talk when there was a break in the music or the volume lessened. Sharif said these periods were usually very short so he and the other prisoners would immediately take the opportunity to shout to each other. Once, the break lasted an entire day: “One day there was a day-long failure of the music so it was a great opportunity for us to talk,” said Sharif.<sup>135</sup> They would try and remember names and details of each other’s cases so that if anyone got released, they could communicate this information to their families and the outside world.

From this type of communication, Shoroeyia was able to provide a list of those who he believed were detained within this facility. Some he just knew by nickname or first name and where they were from.<sup>136</sup> They include:<sup>137</sup>

---

<sup>134</sup> Although it was dark much of the time he was held in this facility, Shoroeyia said he was able to create a sketch of the premises based on his occasional conversations with other prisoners over the loud music and what he could see of the facility when he was being transported from one room to another. Bashmilah drew depictions of the facility where he was detained that are similar to Shoroeyia’s. See Bashmilah Declaration, paras. 55-78, Exhibits H, I, and N. The experience of another detainee, Khaled al-Maqtari, also corroborates the testimonies of Shoroeyia and Sharif. After his release in May 2007, Maqtari described being detained at a facility in Afghanistan during the same time period and under similar conditions. He further noted that, while at that facility, he spoke or came into contact with Bashmilah, “Adnan al-Libi” (an alias for Maghrebî), “Riba’i” (an alias for Shoroeyia), and “Hazim” (an alias for Sharif). See Amnesty International, *A Case to Answer*, March 2008, <http://www.amnesty.org/en/library/info/AMR51/013/2008/en>, (accessed August 27, 2012), p. 19-22.

<sup>135</sup> Human Rights Watch interview with Sharif, March 14, 2012.

<sup>136</sup> Maqtari has offered a similar list of names for those he was detained with. “I think Riba’i may have been Tunisian, but he was very far away; Hazim is Libyan; Naseem is Tunisian; Adnan is Libyan of course; Marwan al-Adenni is a Yemeni from Aden,



Abu Yasser al Jazairi, from Algeria;<sup>138</sup> Omeir, from Yemen;<sup>139</sup> Reyad, from Yemen; Khalid Sharif; Majed;<sup>140</sup> Nassem; Ahmad, from Malaysia; Malik, from Saudi Arabia; Mu'ad, from Syria; Saleh De'ayki;<sup>141</sup> Ibn Sheikh;<sup>142</sup> Marwan, from Yemen; and Ayoub.<sup>143</sup>

From the sound of their voices and information he obtained from other prisoners, Shoroeyia drew where he believed each individual was detained within the facility.<sup>144</sup>

---

he is here now [meaning in Yemen], and so is Shumilla [Muhammad Bashmilah]... Riyadh Haitham al-Sharqawi—they were calling him Riyadh. And Abu Malik al-Qasemi was another Yemeni. Also there was Abu Ahmed, who was called Abu Ahmed 'the Malaysian.' Abu Mu'ath al-Suri was very near me, and Abu Yasser al-Jaza'iri was near to Ahmed." Maqtari clarified in a later interview that he actually thought "Riba'i" (Shoroeyia) was Libyan. Amnesty International, *A Case to Answer*, p. 19-22.

<sup>137</sup> Human Rights Watch interview with Shoroeyia, March 18, 2012.

<sup>138</sup> A prisoner with a virtually identical name (Yassir al-Jazeera), though identified as being Moroccan, not Algerian, was reportedly apprehended on March 15, 2003 in Lahore, Pakistan and at some point transferred to a CIA-operated section of Bagram Air Base, Afghanistan, where he was held from late 2003 through early 2004. In December 2006, another prisoner who was in US custody in a different US-run facility in Afghanistan, Marwan Jabour, reportedly saw al-Jazeera and was allowed to meet with him on several occasions. During these times, al-Jazeera, told him that he had been in a place with US interrogators where he had been tortured, and that he had permanent damage to his arm as a result of being badly beaten. Jabour said, "I saw very clearly the marks of torture on his body." Al-Jazeera also indicated that he had been subjected to loud music for four months straight. In 2003, the US government acknowledged that Yassir al-Jazeera had been captured or killed. On July 19, 2006 his name was included in the "Terrorists No Longer a Threat" List. Human Rights Watch, *Off the Record: US Responsibility for Enforced Disappearances in the "War on Terror,"* June 7, 2007, <http://www.hrw.org/legacy/backgrounder/usa/cto607/cto607web.pdf>, p. 15. Bashmilah also heard Yassir al-Jazeera talking while he was detained in Afghanistan. Bashmilah Declaration, para. 102.

<sup>139</sup> Shoroeyia places Omeir from Yemen in cell 6 but Bashmilah, also from Yemen, identifies himself as the occupant of cell 6. Bashmilah Declaration, para. 53.

<sup>140</sup> Shortened form of Majed Mokhtar Sasy al-Maghrebi, who was also interviewed by Human Rights Watch for this report..

<sup>141</sup> Alternate spelling for Saleh Di'iki, who was also interviewed by Human Rights Watch for this report and whose experience is recounted in a later section. Di'iki said he was detained with Shoroeyia and Sharif in the first facility and was sent back to Libya on August 22, 2004 on the same plane as Shoroeyia and Majed Mokhtar Sasy al-Maghrebi. Human Rights Watch telephone interview with Di'iki, May 24, 2012.

<sup>142</sup> Family members and others detained with Ibn Sheikh (short for Ibn Sheikh al-Libi or Ibn Sheikh from Libya), whose real name was Mohamed al-Fakheri, were interviewed for this report.

<sup>143</sup> "Ayoub" is an alias used by Mustafa Jawda al-Mehdi, who was also interviewed by Human Rights Watch for this report.

<sup>144</sup> Human Rights Watch interview with Shoroeyia, March 18, 2012. Not every cell in the facility is depicted in this diagram. The numbered cells continued in the direction of the arrow. Shoroeyia believed that those not depicted in cells on this page were in cells numbered higher up in the direction of the arrow and that there were approximately 15 cells total in the facility.

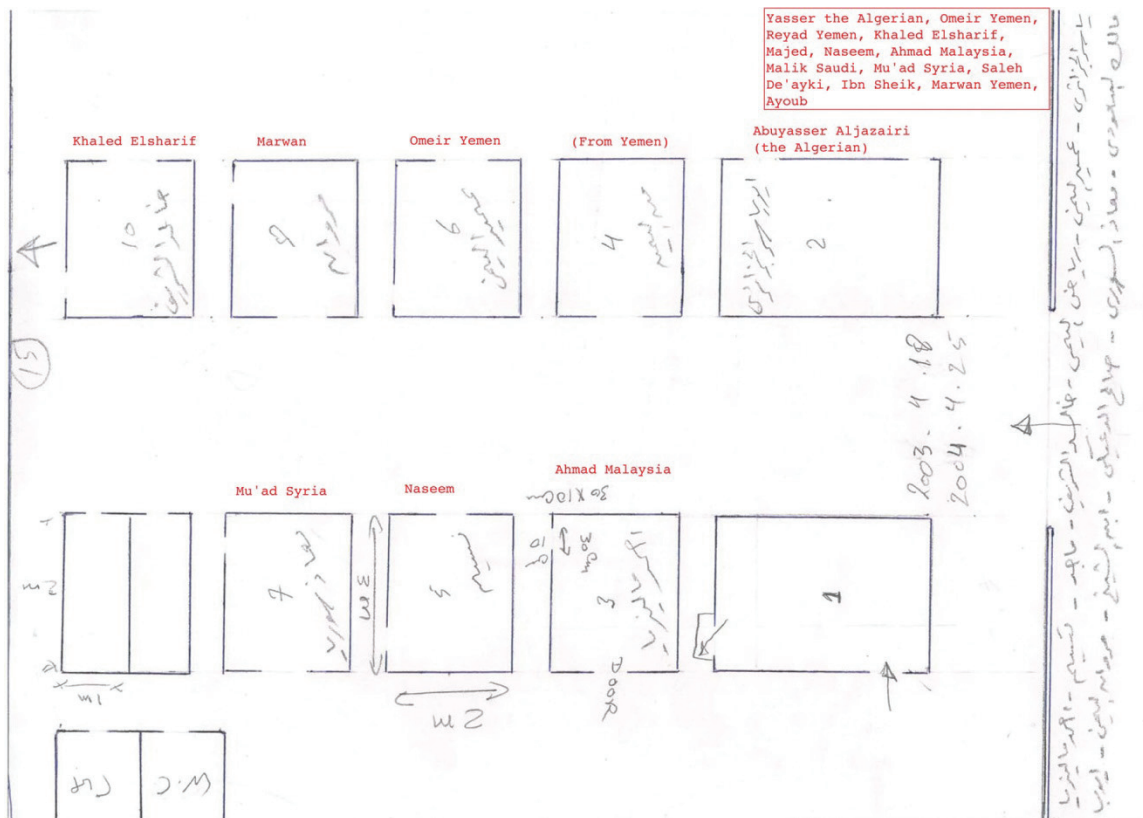

Mohammed Shoroeyia drew this rough depiction of the facility in Afghanistan where he was held for nearly a year. The typed, red writing are English translations of the Arabic names Shoroeyia drew in pencil on this sketch. © 2012 Mohammed Shoroeyia.

Sharif also said that he was either able to speak to, or heard the voices of, other prisoners during his detention in this facility:<sup>145</sup>

Abu Nasseem al-Tunisi; Marwan al-Yemeni; Assad Allah—the son of Sheikh Ibn Omar Abdul Rahman—from Libya; Shoroeyia; Majed Adnan;<sup>146</sup> Salah al Di'iki;<sup>147</sup> someone from Malaysia whose name he could not remember; someone from Baluchistan; Abu Ammar, but he was not sure of his name; and Ibn Sheikh al-Libi.<sup>148</sup>

<sup>145</sup> Human Rights Watch telephone interview with Sharif, May 24, 2012.

<sup>146</sup> Maghrebi acknowledged going by the name of Adnan al-Libi (or Adnan the Libyan) in an interview with Human Rights Watch, Tripoli, Libya, March 16, 2012.

<sup>147</sup> Human Rights Watch interviewed Di'iki in Tripoli on March 18 and 19, 2012.

<sup>148</sup> Family members and others detained with Ibn Sheikh al-Libi (or Ibn Sheikh from Libya), whose birth name is Mohamed al-Fakheri, were interviewed for this report.

Sharif also said he learned the names of some prisoners he was told were there before he arrived, who he believed were transferred to Guantanamo.<sup>149</sup> They were:

Abu al-Faraj al Libi;<sup>150</sup> Nuqman from Zliten; Abu Ahmad; Abu Omar al Baidawi, from al Bayda; and Munir al Khomsi, from Khoms.

Sharif said his cell was about 4 x 3 meters. It had a steel door in the middle and a window with steel bars over the door. On what he described as the backside of the cell there was also another small window.<sup>151</sup> Shoroeiya did not provide measurements for his cell, but he said it was slightly bigger, and drew it as slightly bigger than Sharif's cell. Shoroeiya's cell also had a door with a window at the top with bars on it and a slot in the middle of the door that the guards used to pass food through and check on him occasionally. There was a small window, about 10 x 30 centimeters that had bars on it too, was about 13 centimeters from the ground, and provided some ventilation.<sup>152</sup> He added that it also "was a very good entrance for rats."<sup>153</sup>

In their cells, during the first three to four months of interrogation, which both called the first "period" of interrogation, each was chained to two iron rings that came out of the wall. Shoroeiya said the rings were about one meter above the ground. They described being chained to these rings, sometimes by one arm so that the other arm and both legs were free (Position 1); sometimes by both arms with both legs free or at times chained together (Position 2); and sometimes both legs and arms were all shackled to the ring together (Position 3;). Later, after about a four-month period of intense interrogation and abuse, Shoroeiya said he was allowed to be unchained in his cell and to walk freely around it.

---

<sup>149</sup> Human Rights Watch telephone interview with Sharif, May 24, 2012.

<sup>150</sup> Abu Faraj al Libi, at the time of this writing, was one of four Libyans still held in Guantanamo. See "The Guantanamo Docket," *New York Times*, <http://projects.nytimes.com/guantanamo/country/libya> (accessed May 27, 2012). Of these five named, only Abu al-Faraj al-Libi was known to be, at the time of this writing, ever at Guantanamo.

<sup>151</sup> Human Rights Watch interview with Sharif, March 14, 2012.

<sup>152</sup> Bashmilah described cell conditions very similar to what both Shoroeiya and Sharif described. See Bashmilah Declaration, paras. 56-60 and Exhibit I.

<sup>153</sup> Human Rights Watch interview with Shoroeiya, March 18, 2012.



Position 1<sup>154</sup>



Position 2

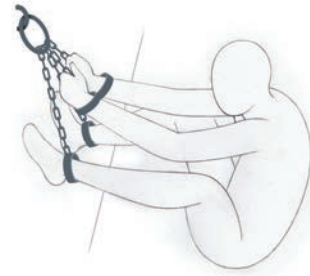

Position 3

**“I would try to take that time to use the bucket for a toilet I had in my room, but could not do so all the time, so I usually would just pass urine through my clothes.”**

Sharif said that at one point he spent two weeks in position 3, with both his arms and legs shackled to the iron ring. During this time, they would unchain him only once a day for half an hour to eat the one meal they gave him. Afterwards they would chain his hands and feet back up to the wall: “I would try to take that time to use the bucket for a toilet I had in my room, but could not do so all the time, so I usually would just pass urine through my clothes.”<sup>155</sup>

Shoroeiya said he was in either position 1, 2, or 3 in his cell for four months continuously after he first arrived. After four months he was not shackled or handcuffed but was able to move freely around his cell until he was moved to the second place of his detention in

---

<sup>154</sup> Four of the men interviewed for this report, Mohammed al-Shoroeiya, Khalid al-Sharif, Majid al-Maghrebi, and Saleh Di’iki, said that for most of the duration of their detention at the first site in Afghanistan they were held in one of the three positions depicted here (referred to in this report as Positions 1, 2, and 3). They were held in these positions for varying amounts of time ranging from multiple days to months. For more details regarding an individual detainee’s imprisonment refer to the section of the report documenting his specific experience. These illustrations were drawn based on the testimony and re-enactments of the positions by the victims. One of victims, Khalid Sherif, was shown the three images and said they were very accurate depictions.

<sup>155</sup> Human Rights Watch interview with Sharif, March 14, 2012.

Afghanistan on April 25, 2004. Both men said they were not able to shower or bathe during the first several months of their detention.

“For the first three months we were not able to have any showers. We could not wash our bodies.”<sup>156</sup> Shoroeiya said of that same time period, “That whole time we didn’t even get a drop of water over our body. We couldn’t cut our hair or even the nails of our fingers. We looked horrible. We looked like monsters.”<sup>157</sup> After this first period, they were allowed to shower for 10 to 15 minutes weekly. They were also allowed some exposure to the sun, for a short period of time, mostly once a week for the whole year.<sup>158</sup>

“That whole time we didn’t even get a drop of water over our body. We couldn’t cut our hair or even the nails of our fingers. We looked horrible. We looked like monsters.”

Sharif said sometimes his captors sent him to a cell where his hands were suspended above his head for significant periods of time. One time this period lasted three days. During this time he was provided limited sustenance:

They only gave me water once, at night. They gave me a milkshake and a small cup of milk with cocoa. That was all I had for three days. They banned me from going to the restroom for those three days. I had to pass urine and go to the bathroom standing up. I wasn’t wearing clothes. At night, they gave me some water to drink but poured the rest of it over my body. I was trying to move to create some warmth in my body. Because of the lack of sleep for three days, I went hysterical. I thought I was going crazy. Everything was spinning around me and it was totally dark.<sup>159</sup>

---

<sup>156</sup> Ibid.

<sup>157</sup> Human Rights Watch interview with Shoroeiya, March 18, 2012.

<sup>158</sup> Human Rights Watch interview with Sharif, March 14, 2012.

<sup>159</sup> Ibid.

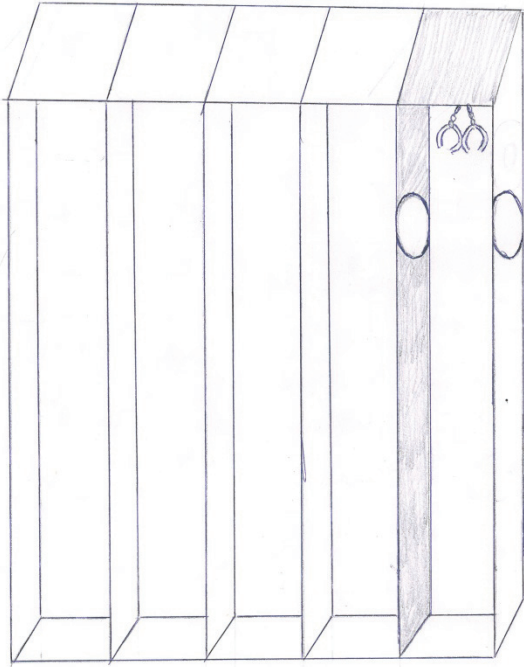

A sketch by Mohammed Shoroeiya depicts a narrow windowless box where he said he was held naked for one and a half days.

© 2012 Mohammed Shoroeiya

On another occasion he said he was in a room that was about 1.5 x 1.5 meters.<sup>160</sup> Again his hands were suspended above his head from an iron bar that went between the walls. His feet could touch the ground but he also could only stand on one foot because his broken foot was still not healed. There were no windows and it was dark, but there were small, “yellow” holes. He could see a small red light that made him think there may have been a camera in there. They left him there for several hours.

Shoroeiya said that when he first arrived, he was also put in a place with his hands suspended above his head in a similar position, though he describes the conditions differently.

He said it was a very narrow room or box, about 0.5 meters wide and just high enough for him to stand with his hands above his head. He is 1.75 meters tall. His hands were handcuffed to a bar that went across the top of the room. There were other rooms next to his. His feet could touch the floor but he could only stand on one leg because the other leg was still broken and very swollen. Speakers built into the walls of the box were on each side of his head just centimeters to his ears blasting loud Western music. There were no windows. It was dark but there was just enough light to see what he said looked like blood stains on the walls. He was held there, with his hands suspended above his head, for one and a half days, with no food, naked, with the music blasting loudly the entire time.

---

<sup>160</sup> It is unclear if this is the same room or a different room than Sharif mentioned he was in previously.

Shoroeiya and Sharif both alleged this facility was run by Americans. With one exception, however, they said the Americans were not wearing official uniforms.<sup>161</sup> Shoroeiya said all of the Americans were dressed in black with caps on their heads and sometimes, when they carried out severe physical abuse, they wore masks. They were able to see some of this, despite the darkness, because guards and interrogators would come to them with lights on their foreheads and flashlights in their hands.

Afghan guards brought them food and maintained the facility, but mostly the Americans ran it. Shoroeiya said he knew the guards were Afghan because he spoke Dari and Pashto, and some of them spoke to him in these languages when he first arrived and occasionally afterwards. After some time, however, the guards stopped all interactions entirely. Shoroeiya said the guards wore traditional Afghan clothes in the beginning but then later began also wearing black clothes with military boots and facemasks similar to the attire of the Americans. Sharif said that when he spoke Pashto or Dari, the guards never spoke back but would sometimes give indications that they understood what he was saying. He also said their dress was “mixed,” with some in Afghan clothes and some all in black with black facemasks.<sup>162</sup>

“I found a woman there who was screaming and beat on the table. She literally told me, ‘Now you are under the custody of the United States of America. In this place there will be no human rights. Since September 11, we have forgotten about something called human rights. If you think you are going to stay here in a very good room and get your newspaper daily, you are wrong.’”

When asked how they knew they were in US custody, they each said it was made very clear. Sharif said that after he arrived at the facility:

---

<sup>161</sup> Sharif said he saw one man several times in both facilities, who he said was American and from the “army.” He wore a military uniform, spoke English, and usually had an interpreter with him. Sharif described him as tall and thin. He also had a shaved head and wore a red beret. He believes he was the prison director. He described him as one of the few Americans there with whom he used to have “actual conversations.” “We had some small talk. We would talk about the differences between the US and Arab countries,” Sharif said.

<sup>162</sup> Bashmilah also said the Afghan guards were always masked and that he heard some of the other prisoners saying they overheard them speaking to each other in Pashto and Farsi. Bashmilah Declaration, paras. 82-83. Maqtari similarly stated, “all of the prison staff wore black clothes ... the guards were gloved and masked.” See Amnesty International, *A Case to Answer*, p. 16.

I was approached by a tall, thin officer from the army [he was in uniform] who told me he was American. He was bald, but not naturally—his head was shaved. He had a lamp with a light on his head and was with a translator. And the room was totally dark—the only light in there was the light on his head. He started threatening me. He said, ‘Now we can kill you and no one will know. We want to hear about your last plan to strike America. All of what you said in Peshawar, we are not interested in that. We want new things now.’<sup>163</sup>

Later this army officer would suddenly be very nice to Sharif, asking if his leg was hurting and promising to get him some medical attention for it.

Shoroeiya said that within the complex, there were several types of rooms. One was a group of rooms where he was interrogated. Another set of rooms were freezing cold and were used to submerge the prisoners in icy water while lying on plastic sheeting on the ground. A third set of rooms he called the “torture rooms,” where they used specific instruments. One of these instruments was a wood plank that they used to abuse him with water.

Although he did not refer to the abuse he received as waterboarding, the abuse he described fit that description.<sup>164</sup>

---

<sup>163</sup> Bashmilah also described an American official with a shaved head that he concluded was responsible for the harsh torture of certain other prisoners including Adnan al-Libi (Maghrebi). Bashmilah nicknamed this American “Kojak.” See Bashmilah Declaration, paras. 69-70.

<sup>164</sup> Waterboarding was one of 12 Enhanced Interrogation Techniques (EITs) the CIA requested permission to use. See “Department of Justice Office of Professional Responsibility Report,” (DOJ OPR Report, July 29, 2009), July 29, 2009, <http://judiciary.house.gov/hearings/pdf/OPRFinalReport090729.pdf> (accessed August 27, 2012), p. 35-36. The CIA’s request describes waterboarding in the following manner: “The subject is restrained on a bench with his feet elevated above his head. His head is immobilized and an interrogator places a cloth over his mouth and nose while pouring water onto the cloth. Airflow is restricted for twenty to forty seconds; the technique produces the sensation of drowning and suffocation.” DOJ OPR Report, July 29, 2009, p. 36. The Department of Justice approved the use of waterboarding on August 1, 2001. “Office of Legal Counsel, Memorandum for John Rizzo, Acting General Counsel of the Central Intelligence Agency, Re: Interrogation of an al Qaeda Operative,” August 1, 2002, [http://media.luxmedia.com/aclu/olc\\_08012002\\_bybee.pdf](http://media.luxmedia.com/aclu/olc_08012002_bybee.pdf) (accessed August 26, 2012), p. 11. See also reference to a “classified Bybee memo” also approving the techniques on pages 1-2. DOJ OPR Report, July 29, 2009, p. 68.



## The Interrogators

Shoroeiya said the interrogators, all of whom he believed were American, came to him in three waves.<sup>165</sup> The first group would do a sort of soft interrogation, just asking questions. They were wearing what Shoroeiya described as “special forces” black uniforms with black caps on but no masks. Then the second group would come in. They were also wearing the same type of black uniforms with caps on, but unlike the first group, had what appeared to be some sort of bodyguards with them. “They were tougher,” he said. They had “some sort of specialists in this group who were very rough with us and who did the beatings,” he said. “The third group was the toughest.” They also wore the same black uniforms, but their faces were masked. They were the ones that used what he called “torture instruments:” the waterboard, the small box, and a tall, thin box. Sharif said the interrogators were assisted by interpreters who, based on their accents, he believed to be from different Arab countries, possibly including Lebanon, Egypt, Algeria, and Syria.<sup>166</sup> Sharif also mentioned that at times he had been interrogated by women while he was naked. It was not clear if this occurred in one or both of the places in Afghanistan where he was detained.<sup>167</sup>

## Waterboarding

Shoroeiya said the board was made of wood and could turn around 360 degrees (see above).<sup>168</sup> Sometimes they would strap him onto the board and spin him around while wearing a hood that covered his nose and mouth. This would completely disorient him. While he was strapped to the board with his head lower than his feet, they would pour buckets of extremely cold water over his nose and mouth to the point that he felt he was going to suffocate. After the hood was put over his face, he said, “then there is the water pouring.... They start to pour water to the point where you feel like you are suffocating.”<sup>169</sup> When asked how many times this was done to him, he said “a lot ...a lot ... it happened many times .... They pour buckets of water all over you.”<sup>170</sup>

---

<sup>165</sup> Human Rights Watch telephone interview with Shoroeiya, May 7, 2012.

<sup>166</sup> Human Rights Watch telephone interview with Sharif, May 24, 2012.

<sup>167</sup> Human Rights Watch interview with Sharif, March 14, 2012.

<sup>168</sup> During Human Rights Watch’s interview with Shoroeiya while he was in Abu Salim in 2009, he also told Human Rights Watch researchers about this board and drew a picture of it in a researcher’s notes.

<sup>169</sup> Human Rights Watch interview with Shoroeiya, March 18, 2012

<sup>170</sup> Ibid.

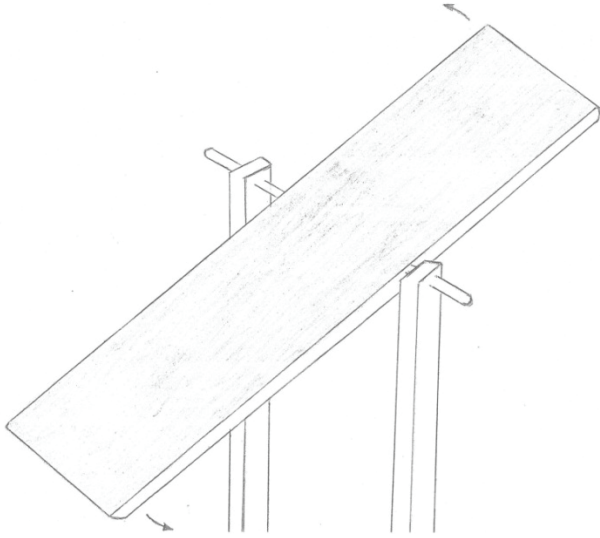

A sketch by Mohammed Shoroeiya depicts a wooden board to which he was strapped and on which his interrogators put him when he underwent abuse with water. © 2012 Mohammed Shoroeiya

Shoroeiya in a later interview explained that each session took about half an hour, and during this half hour he was waterboarded

many times.<sup>171</sup> He said he felt like each time lasted about three minutes but said there was no way to really tell time. When told that the United States had admitted to doing this to a few people for between 20 and 40 seconds each time, he said he was sure his sessions were definitely longer than that.<sup>172</sup> He said: “I could hold my breath for 20, even 40 seconds, so it was definitely longer than that.”<sup>173</sup> They would do this numerous times over and over again during a session. They would ask him questions in between. He told Human Rights Watch,

“They wouldn’t stop until they got some kind of answer from me.”

---

<sup>171</sup> Human Rights Watch telephone interview with Shoroeiya, May 7, 2012

<sup>172</sup> Malcom Nance, author, counterterrorism specialist, and former US Navy SERE (Survival, Evasion, Resistance and Escape) instructor, who was consulted about this case, said, “When you are on the board you have no idea how much time is really going by, time literally stands still.” When the procedure was being administered on him (Nance), for example, he thought it lasted about three minutes, when in fact it was only about 30 seconds. “You have no idea what is happening to you, you panic.”

<sup>173</sup> When asked about this comment, Nance said, “He might have thought that holding his breath was helping him resist but if it [waterboarding] is being administered properly holding your breath is not really going to help. Everyone develops their own method of resistance and maybe this was part of his, but you can’t really resist waterboarding by holding your breath.” See also Department of Justice Guidance on Waterboarding from Steven Bradbury, Principle Deputy Assistant Attorney General at the time, explaining one thing an interrogator can do if a detainee tries to resist waterboarding by holding his breath: “In addition, you have informed us that the technique may be applied in a manner to defeat efforts by the detainee to hold his breath by, for example, beginning an application of water as the detainee is exhaling.” Memo from Steven Bradbury, Principle Deputy Assistant Attorney General, to John Rizzo, Senior Deputy General Counsel, CIA, May 10, 2005, [http://media.luxmedia.com/aclu/olc\\_05102005\\_bradbury46pg.pdf](http://media.luxmedia.com/aclu/olc_05102005_bradbury46pg.pdf) (accessed August 28, 2012), p. 13.

He said there were doctors present. He knows they were doctors because his leg was broken while he was there and he was treated by these same people. The doctors would monitor him as the cold water was poured on him, and when his body temperature got too low, they would order warm water be added to the cold. Once his temperature was okay, they would begin adding cold water again.<sup>174</sup>

“They wouldn’t stop until they got some kind of answer from me.”

In addition to waterboarding, his interrogators would also make a sort of basin out of a type of plastic sheeting. They would have him lie down on the floor in the basin and then pour freezing water over him. Shoroeyia said the water was so cold it had a gel-like, icy texture. Again, when his body temperature got too cold, they would pour warmer water on him. Doctors were present during these sessions also, monitoring his body temperature. He was often naked when subjected to both types of abuse with water.<sup>175</sup>

Sharif described being subjected to a similar type of treatment, though not with a board.<sup>176</sup> He said he was threatened with use of the board, was shown the board, and was aware it was being used on other prisoners, but that it was not used with him. During this treatment, Sharif would be made to lie down on his back on plastic sheeting while guards would hold the sides of it up, so that when water was poured in, it would not spill out. The water was freezing cold, with an icy, gel-like consistency. His whole body was lying in it. While this was going on he would be made to wear a black hood made out of thick cloth over his head and they would also pour jugs of freezing cold water directly over his nose and mouth. Sharif told Human Rights Watch:

Sometimes they put a hood over my head and they lay me down and they start to put water in my mouth.... They poured the water over my mouth and

---

<sup>174</sup> The Department of Justice, in approving the use of waterboarding, made reference to the fact that a doctor would be present during the procedure. Office of Legal Counsel, Memorandum for John Rizzo, Acting General Counsel of the Central Intelligence Agency, Re: Interrogation of an al Qaeda Operative, August 1, 2002, [http://media.luxmedia.com/aclu/olc\\_08012002\\_bybee.pdf](http://media.luxmedia.com/aclu/olc_08012002_bybee.pdf) (accessed August 26, 2012), p. 4 (“We also understand that a medical expert with SERE experience will be present throughout this phase and that the procedures will be stopped if deemed medically necessary to prevent severe mental or physical harm to Zubaydah.”).

<sup>175</sup> Shoroeyia also described being subjected to this treatment when he spoke to Human Rights Watch researchers in Abu Salim prison in 2009.

<sup>176</sup> Human Rights Watch interview with Sharif, March 14, 2012.

nose so I had the feeling that I was drowning. I couldn't breathe.... I tried to turn my head left and right as much as I could to take in some gulps of breath. I felt as if I was suffocating.<sup>177</sup>

When asked how often this happened, he said he could not be sure about the number of times or how long the sessions lasted:

"I really can't be sure about the numbers. I spent three months getting interrogated heavily during the first period and they gave me a different type of torture every day. Sometimes they used water, sometimes not.... Sometimes they stripped me naked and sometimes they left me clothed."<sup>178</sup>

Sharif said a male doctor was present during the sessions with water. He could feel him putting his hands on his upper arms while he was undergoing this treatment, as if he were measuring his body temperature. He would then tell others in the room to either continue with the treatment or stop.<sup>179</sup> Sharif also said that the cast he had on his leg due to his broken foot became soft as a result of this water treatment, so the doctor put another type of cast on him that had three sides that could be removed. They would take off his leg cast before the sessions with water and then put it back on afterwards, binding it with mesh.<sup>180</sup>

### **Wooden Box**

Shoroeiya described the use of a small wooden box, about 1 x 1 meter in size, with a lock on it and small holes on the sides. A number of times his American interrogators would threaten to lock him in the box. He said that he was only actually put in there on one occasion which lasted for an hour or more.<sup>181</sup> While in the box, they prodded him with long thin objects through the holes on the side of the box.<sup>182</sup>

---

<sup>177</sup>Human Rights Watch telephone interview with Sharif, May 24, 2012.

<sup>178</sup>Ibid.

<sup>179</sup> Sharif understands some English.

<sup>180</sup> Human Rights Watch telephone interview with Sharif, May 24, 2012.

<sup>181</sup> The use of "cramped confinement" was another technique on the list of EITs the CIA requested permission to use and that the Department of Justice approved on August 1, 2002. The CIA's request to use this technique described it in the following manner: "The subject is placed in a confined space, typically a small or large box, which is usually dark. Confinement in the smaller space lasts no more than two hours and in the larger space up to 18 hours." See DOJ OPR Report, July 29, 2009, p. 35-36. See also "Memorandum for John Rizzo," p. 13-15, 18, approving the technique for Zubaydah,

Mohammed Shoroeiya said his interrogators would sometimes threaten to lock him in a small wooden box, such as the one drawn by him above, and once did lock him in the box.

© 2012 Mohammed Shoroeiya

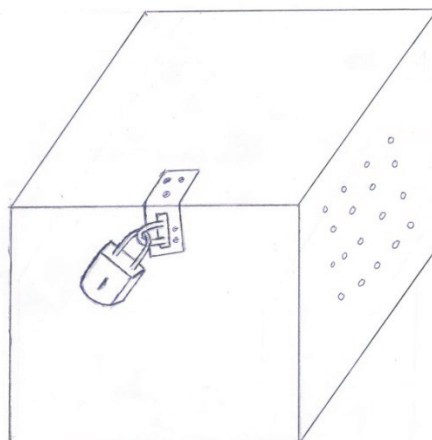

Sharif said he was threatened with use of a box that fit the same description, but they never actually put him inside. He told Human Rights Watch, “Then he [the interrogator] brought me a small box. They said, ‘We are going to push you into this box and we will close it. That’s what’s going to happen to you if you don’t talk and tell us everything. We will squeeze you until you fit inside this box.’”<sup>183</sup>

### Wooden Wall

Both Shoroeiya and Sharif said they at times were taken to a room that had a wooden wall and Americans beat them against it. Sharif said, “They had a ring covered with foam that they would put around my neck and then they would push me against the wall. They were also slapping and punching my face and torso.” Sharif explained that his back was to the wooden wall when he was being pushed into it.<sup>184</sup>

Sharif said that the Americans warned him that unless he was more cooperative, they would strap him to a table (pointing to a steel one that was in the room), turn him upside down and leave him like that until he died.

---

[http://media.luxmedia.com/aclu/olc\\_o8o12o02\\_bybee.pdf](http://media.luxmedia.com/aclu/olc_o8o12o02_bybee.pdf) (accessed August 26, 2012), p. 18. See also DOJ OPR Report reference to a “classified Bybee memo” also approving the technique on pages 1-2, DOJ OPR Report, July 29, 2009, p. 68.

<sup>182</sup> Human Rights Watch interview with Shoroeiya, March 18, 2012.

<sup>183</sup> Human Rights Watch interview with Sharif, March 14, 2012.

<sup>184</sup> “Walling” was another of the 12 EITs the CIA asked permission to use on detainees and the Justice Department approved. The request for its use was described in the following manner: “the subject is pulled forward and then quickly and firmly pushed into a flexible false wall so that his shoulder blades hit the wall. His head and neck are supported with a rolled towel to prevent whiplash.” DOJ OPR Report, July 29, 2009, p. 35-36; See also “Memorandum for John Rizzo,” p. 11.

## *Afghanistan II*

Shoroeyia said he was moved with other prisoners to another facility on April 25, 2004.<sup>185</sup> Sharif said the transfer took place sometime between April 20 and 25, 2004.<sup>186</sup> Sharif said he knew he was in a group because he could hear voices all around him, but he was not sure who was in the group.<sup>187</sup> Shoroeyia believes Sharif was among those moved with him.<sup>188</sup>

Sharif said he went through a process similar to what he went through when he was taken from Islamabad to the first detention facility in Afghanistan: his captors cut off all his clothes; examined his mouth, eyes, and ears; took pictures of him while naked; put him back in diapers; and put him back in clothes. They then put plugs in his ears, covered his eyes, and put a hood over his head and headphones over his ears on the outside of his hood.<sup>189</sup> Shoroeyia described similar treatment during the move and said whenever they moved him from place to place he went through the same process. Then they were put in a plane and flown somewhere. The plane took off from someplace very near where they were being detained. They knew this because they did not have to travel very far to get to the plane. Once they landed they were rushed to a helicopter and flown somewhere again.<sup>190</sup>

After landing, they were taken to a new detention facility about a five minute drive from where they landed. They were sure it was still in Afghanistan, though again, they were not sure exactly which part of Afghanistan. “We lived in Afghanistan for a long time. We know the atmosphere and the climate there,” said Shoroeyia. “When you look at the buildings, you can tell from the structure and the materials they are made out of that it is Afghani-

---

<sup>185</sup> Human Rights Watch interview with Shoroeyia, March 18, 2012.

<sup>186</sup> Human Rights Watch interview with Sharif, March 14, 2012.

<sup>187</sup> Ibid.

<sup>188</sup> Human Rights Watch interview with Shoroeyia, March 18, 2012.

<sup>189</sup> Human Rights Watch interview with Sharif, March 14, 2012. See text box, “CIA Rendition Transportation Procedures,” (above).

<sup>190</sup> Both Bashmilah and Maqtari were moved to a second facility around the same time and in the same manner, but both thought the second detention facility might not have been in Afghanistan but somewhere else in the Middle East or Europe. Despite the disagreement over location, Bashmilah suggests that at least he, Shoroeyia, and Sharif had all ended up in the same place. He states, “My cell was part of a cluster of three cells.... There were two other detainees in my cluster whose voices I recognized from the detention facility in Afghanistan and who I heard identify themselves as Hazem [Sharif] and Raba’i (Rib’i) [Shoroeyia].” Bashmilah Declaration, paras. 84-92, 101-102. Maqtari thought nine detainees had been transferred to the new facility from the previous site in Afghanistan, based on the fact that he saw “nine separate body charts on the doctor’s desk” as he was prepared by the doctor for removal. Amnesty International believes that in addition to Maqtari, the nine included Bashmilah, Shoroeyia, and Maghrebi. Amnesty International, *A Case to Answer*, March 2008, p. 26-27.

stan.”<sup>191</sup> Both thought they might have been taken to a location not far from where they were previously detained, but neither could be sure. They suspected the plane and helicopter flights were intended to deceive them into thinking they had been moved far away because their captors, who they again alleged were Americans, seemed to go to a lot of effort, in addition to the flights, to make them think they were somewhere else.<sup>192</sup> They brought in food from places like Turkey and Germany, Shoroeiya said.<sup>193</sup> They asked them where they thought they were and when they answered Afghanistan, they asked them, “Why, how can you be sure?”<sup>194</sup>

Shoroeiya said the structure of the second location differed from the first in that it was more like a building than a hangar.<sup>195</sup> Sharif also said the facility was much newer: “This place was brand new. We could tell it was new because everything in it was new, even the toilets, and there were all new cameras, and all new microphones and speakers everywhere.”<sup>196</sup> Shoroeiya also said there were cameras everywhere.<sup>197</sup> In the prior location, Sharif said, there were not cameras and microphones everywhere, just loudspeakers.

Shoroeiya described the building itself where the cells were contained as being “closed and tight.”<sup>198</sup> The cells themselves had only a door, not a gate, and there was “no ventilation at all in there.”<sup>199</sup> Sharif also said “it was all closed in, no bars, just walls.”<sup>200</sup> This

---

<sup>191</sup> Human Rights Watch interview with Shoroeiya, March 18, 2012.

<sup>192</sup> Human Rights Watch interviews with Sharif, March 14, 2012; and Shoroeiya, March 18, 2012.

<sup>193</sup> Human Rights Watch interview with Shoroeiya, March 18, 2012.

<sup>194</sup> Ibid. Shoroeiya and Sharif were not the only prisoners who believed the facility was in Afghanistan. This belief was shared by Marwan Jabour, a detainee who was brought to the site in June 2004 after being previously held in Pakistan and who provides further corroboration of Shoroeiya and Sharif’s testimony. Not only did Jabour offer similar descriptions of the facility and the treatment he received, but he also identified by name some of the prisoners who had arrived from Afghanistan with Shoroeiya and Sharif. Jabour said that at one point during a break in noise at the facility, a number of prisoners gave their names. These included “Adnan” (Maghrebi), Abu Yassir al-Jazeera, and Ayoub al-Libi (an alias for Mustafa Jawda al-Mehdi, who was also interviewed for this report). Human Rights Watch, *Ghost Prisoner*, p. 13-14, 21.

<sup>195</sup> Human Rights Watch telephone interview with Shoroeiya, May 8, 2012.

<sup>196</sup> Human Rights Watch interview with Sharif, March 14, 2012.

<sup>197</sup> Human Rights Watch interview with Shoroeiya, March 18, 2012.

<sup>198</sup> Ibid.

<sup>199</sup> Ibid.

<sup>200</sup> Human Rights Watch interview with Sharif, March 14, 2012.

“We were locked to the floor like animals. You could walk around but your legs were still chained.”

time, they both said, they were not handcuffed to a round steel ring connected to a wall but to a long chain that was connected to the floor of their cell.<sup>201</sup>

“We were locked to the floor like animals. You could walk around but your legs were still chained.”<sup>202</sup>

Sharif said he had a toilet and a basin as well as a mattress in his cell.<sup>203</sup> He also said there was a very loud noise, like the sound of a turbine, going on all the time. “When the door to your cell opened, you could hear it very loudly but if your door was kept closed, you couldn’t hear it as well,” Sharif said. “It kept us from being able to speak to each other.”<sup>204</sup> Loud music was also played at times, but it was not continuous like it was in the other location, Sharif said.

In this location, both Shoroeyia and Sharif said there was not the same kind of physical abuse there was in the other location. It was more just isolation, restraint, use of music and noise, and continuous interrogation. Sharif told Human Rights Watch,

The whole period of my detention they were interrogating me. I can’t remember a time I spent more than two days without interrogation. They brought me photos of people from all over the world, photographed in other countries, and they would ask, “Do you know this guy, do you recognize him?” When I would say no, they were astonished. They would say: “How come you don’t know this guy? He was in Pakistan, how come you don’t know him?”<sup>205</sup>

---

<sup>201</sup> Human Rights Watch interviews with Sharif, March 14, 2012; and Shoroeyia, March 18, 2012. Bashmilah also said he was chained by the ankle to his cell floor during the first three to four weeks at the new facility. Bashmilah Declaration, para. 99.

<sup>202</sup> Human Rights Watch interview with Sharif, March 14, 2012.

<sup>203</sup> Ibid. Shoroeyia did not specify whether he had the same.

<sup>204</sup> Ibid. Jabour offered a similar description: “Besides the music, there was also a constant, low-level, white noise.... It sounded like a generator.” Human Rights Watch, *Ghost Prisoner*, p 16.

<sup>205</sup> Human Rights Watch interview with Sharif, March 14.



Shoroeiya said there were intrusive searches and rough treatment, but it was more psychological abuse—not treatment with instruments as in the first location. The American interrogators here were in civilian clothes, not masked and not wearing black.<sup>206</sup> The guards were Afghans and, like the guards at the prior location, wore all black uniforms and facemasks. According to Shoroeiya, however, the guards at the second location looked “neater” and were not the same guards as at the first location.<sup>207</sup>

### *Shoroeiya’s Transfer and Treatment in Libya*

Shoroeiya was sent back to Libya on August 22, 2004. He was threatened many times with being sent back to Libya, but on the day it happened they did not let him know where he was being taken.<sup>208</sup>

After he arrived, Shoroeiya was housed in several different prisons, including Tajoura, al Nasser bureau, Sikka, Ajn Zara, and finally Abu Salim, where he was taken in 2006. Initially he was not mistreated. He said that foreign intelligence chief Musa Kusa personally told him upon arrival that there was some kind of agreement with the United States not to mistreat those who were transferred back to Libya with US assistance. Though he was not abused personally, he heard and saw other prisoners (who had not been sent back with US assistance), being abused. After about six months he too was abused, he said. In addition to long periods of solitary confinement, the guards punched him and beat him with sticks, steel pipes, and electrical cables that were used as a whip. He was bloodied and bruised, but the abuse never resulted in broken or fractured bones. The physical abuse was sporadic and mostly occurred in one prison on Sikka Road. Conditions improved once he got to Abu Salim prison sometime around 2006.

“I didn’t realize I was back in Libya until I actually arrived in Tripoli,” he said. “It was a horrifying feeling. It was terrible.... We knew that Gaddafi had been treating people, especially from our group, in a very bad way.”<sup>209</sup>

---

<sup>206</sup> Human Rights Watch telephone interview with Shoroeiya, May 8, 2012.

<sup>207</sup> Ibid.

<sup>208</sup> Ibid.

<sup>209</sup> Human Rights Watch interview with Shoroeiya, Tripoli, Libya, March 18, 2012.

He had been allowed to see his Algerian wife, Fawziya, and his child, Aisha, for the first time in September 2004. The last time he had seen Aisha, she was nine months old. “By this time [she] was running around and talking,” he said.<sup>210</sup> He saw them again two months later, but then not again until April 2006. After that he received four visits and then no visits for another two years, after which he was able to see his family for about half an hour every 60 days. Several months after her husband was apprehended in Pakistan, Fawziya contacted the Libyan embassy in Pakistan. They did not have any information on her husband’s whereabouts, but made arrangements for her and her daughter to go to Libya to be with Shoroeiya’s family. She had never been to Libya before. It was not until August 2004 that she had any news about her husband. “The first time I knew he was alive was when the Americans handed him over to Musa Kusa,” she told Human Rights Watch.<sup>211</sup>

After several years of detention without charge, Shoroeiya was finally taken to court. On his first appearance, the court read out the charges; the next time, the court appointed him a lawyer; and the third time, the court sentenced him to life in prison.<sup>212</sup> He told Human Rights Watch,

“It was like an absurd play. I was presented to the court in June, met my lawyer once, and then they sentenced me in July. The whole thing, the three days combined, took about an hour.”

Despite the sentence, he said he still was hopeful that he would one day be released. “In all honesty, I could even imagine us sitting here like we are right now, having a conversation,” he said. “I knew there were people like [Human Rights Watch] out there trying to get the truth, letting people know about Gaddafi and all that was going on at Bagram.” Shoroeiya was imprisoned until February 16, 2011, when the uprising began against Gaddafi.

Shoroeiya said the most difficult thing him while in Libyan custody was that he knew how his detention was affecting his family. He said,

---

<sup>210</sup> Human Rights Watch interview with Shoroeiya and his wife, Fawziya, and daughter, Aisha, Misrata, Libya, March 27, 2012.

<sup>211</sup> Human Rights Watch interview with Shoroeiya, Fawziya, and Aisha, March 27, 2012.

<sup>212</sup> Shoroeiya did not make clear with what offense he was actually charged.

“The biggest suffering for any prisoner like myself was the situation with our families. When my daughter comes to me and says they prevented her from going to school or my wife comes to me and says she doesn’t have a dime to spend, that is suffering. You asked me about the physical abuse. That was number 10 on the list of the worst things that I was going through.”<sup>213</sup>

### *Sharif’s Transfer and Treatment in Libya*

Sharif was not returned to Libya until many months after Shoroeiya. Prior to this, his American interrogators frequently asked him what he thought they should do with him. This question was one of the “most disturbing things to me psychologically,” he told Human Rights Watch. By then, he said, “it was clear—they knew I was not associated with al Qaeda and was not a threat to the US. They kept asking me ‘What is the solution for you? We are not just going to open the door for you and let you go.’” He suggested they help him get political asylum in another country; he promised to respect the laws of that country and begged them not to transfer him to Libya. “I will sign any document ... [b]ut please, don’t send me back to Libya. If you send me back there I will be sentenced to death and killed,” he said he told them.

Despite his pleas, Sharif was transferred to Libya on April 20, 2005. His US captors secured his hands, blindfolded him, took off his clothes, examined his body, and took photographs of him naked.<sup>214</sup> They then drove him by car somewhere five or ten minutes away. When they took the hood off his head, he found himself in a shipping container and his arm was handcuffed to a steel ring welded to the wall of the container. The container was in a hangar that appeared to be some sort of military storage facility. He said he could tell because it was filled with boxes of ammunition and other military equipment, even large airplane bombs. At that point he was informed he was being transported to Libya. “I felt like this was the end,” he told Human Rights Watch. “I am a military opponent of the Gaddafi regime, a leader of an armed group against Gaddafi, that participated in actions against him, and now I am going to be handed over, delivered to him.”

---

<sup>213</sup> Human Rights Watch interview with Shoroeiya, March 18, 2012.

<sup>214</sup> Human Rights Watch interview with Sharif, March 14, 2012. See also See text box, “CIA Rendition Transportation Procedures,” (above).

Sharif said that once in Libya, although he was held in extreme isolation for prolonged periods of time, he was not physically abused. “Fortunately, it was the destiny of God or my fate that during this time, Gaddafi was trying to brighten his image with the outside world and build good relationships with the West,” he said. The periods of solitary confinement were extremely difficult: “Even in the cells next to me, there was no one. For six months I was kept like that, not able to talk. Every morning they would bring you what you were going to eat and then leave. ... I could not even hear people walking to and from the bathroom or hear anyone moving around. I was totally and completely alone.”

Unlike Shoroeyia and others, he was held in just two locations: Tajoura, in the same cell for two years and eight months, and then Abu Salim. In January 2008 he was taken to court, convicted of attempting to overthrow the regime, and sentenced to death by firing squad. He said that at one point he was interrogated by individuals speaking French who said they were from the French intelligence service. He was allowed family visits sporadically in the beginning, denied them entirely for a year, and then later allowed to receive regular visits once every two months.

Sharif was released, along with Belhadj and Saadi, on March 23, 2010 after the three publicly renounced their aim of overthrowing the government and the use of violence as a means to political change.<sup>215</sup> Sharif was arrested again on April 28, 2011, a little over two months after the Libyan uprising began. During this period he often witnessed physical abuse including beatings, sometimes with iron rods, and beards being lit on fire, among other things. We did not determine how long Sharif was detained during this period or when he was ultimately released. He is currently head of the Libyan National Guard. One of his responsibilities is security in facilities holding high value detainees, mostly officials of the former Gaddafi government, who are now in the custody of the current Libyan government.

---

<sup>215</sup> Sharif was released with Belhadj and Saadi on this date as part of their negotiated release (see “Libyan Islamic Fighting Group” part of the “Background” section above).

## Majid Mokhtar Sasy al-Maghrebi

Majid al-Maghrebi (Maghrebi)<sup>216</sup> is a former LIFG member who left Libya in 1989. He was arrested in Pakistan in 2003 and detained and ill-treated by Pakistani authorities as well as interrogated by persons he believes were Americans. He was then transferred to Afghanistan, where he was held by the United States. He said US personnel interrogated and physically mistreated him for about eight months. The United States then rendered him to Libya, where he was again subjected to abuse. He was summarily tried and convicted in Libya of trying to overthrow the government and was sentenced to 10 years in prison. He was released on February 16, 2011 when the uprisings against Gaddafi began.



Majid al-Maghrebi. © 2012  
Human Rights Watch

Human Rights Watch interviewed Maghrebi in Tripoli in March 2012. The information in this section is drawn from that interview, unless otherwise noted.<sup>217</sup>

### *Departure from Libya*

Maghrebi was born in 1970. He said he left Libya in November 1989 at the age of 19 because the government had made it clear to him that anyone who was serious about practicing Islam was a target. The authorities came to his house looking for him and some of his friends were arrested, detained, and even killed. “I feared for my life, so I decided to leave.”

Maghrebi left from Benghazi and traveled through Egypt and Saudi Arabia before arriving in Afghanistan in December 1989. There he joined up with other Libyans to become part of the LIFG. Two friends decided to return to Libya to take part in LIFG operations against the

---

<sup>216</sup> Majid Maghrebi’s name has also been spelled “Majed Mukhtar Sasi al-Maghrebi” and Majid Sassi al-Meghrebi. He also confirmed he went by the name Adnan al Libi.

<sup>217</sup> Human Rights Watch interview with Majid Mokhtar Sasy al-Maghrebi, Tripoli, Libya, March 16, 2012.

government, but Maghrebi felt it was too dangerous. His friends were arrested, sent to Abu Salim prison, and killed in the Abu Salim massacre of 1996.

Maghrebi remained in Afghanistan, training in Libyan camps, until after the Soviet-backed Afghan government was overthrown in 1992. He told Human Rights Watch, “[w]e didn’t interfere in the Afghan matter. Our aim was to get rid of the Libyan regime. The Afghan jihad helped me train in how to use guns.” He went to Syria and Saudi Arabia twice, and then from 1995 to 1997 he was with the LIFG in Sudan. From Sudan the LIFG attempted to infiltrate Libya and conduct operations against Gaddafi, which failed. He then went to Pakistan, got married in Peshawar in 1998, and moved to Kabul. He was with the LIFG in Afghanistan in 2000. After the September 11 attacks, he returned to Peshawar.

### *Pakistan*

Maghrebi said that he did not feel Peshawar was safe for him and he moved with his wife and two sons from apartment to apartment. On November 14, 2003 at 1 a.m., Pakistani authorities arrested him at home. They took him to a facility that he believes was in Peshawar and detained him there for 39 days. During this time, Pakistani authorities, who spoke to him in Pashto, repeatedly interrogated him, beating and otherwise ill-treating him. In addition to slapping and punching him, they repeatedly struck him on his bare back with a bamboo stick and a whip made of thick leather. He was not sure the number of times this occurred but estimated about 15 separate occasions. “I was screaming and crying openly,” he said.

He said that on one occasion his interrogators used electric shocks on his feet until he lost consciousness. They did this multiple times that day. Also, nearly every day, they took him downstairs to a room where he was forced to lie on his stomach with his hands handcuffed to the top of a steel frame and his feet handcuffed at the bottom. They would take a rope and tie it around his shackled feet and pull his legs towards his head, stretching him painfully.

Maghrebi said that during his detention in Peshawar, he was interrogated on two occasions by individuals he believes were from the United States—once a few days after he arrived and another time about half-way through his period of confinement. He was blindfolded, so his vision was mostly obstructed, but he believes they were American because he could recognize their American accents; unlike the Pakistanis who spoke to

him in Pashto, they spoke to him in very bad Arabic, and they asked him questions that concerned the United States such as the whereabouts of Osama bin Laden and Abu Faraz al Libi (who, as previously noted, is now detained in Guantanamo). The Americans were not present when he was being beaten, but he thinks it was very unlikely they were not aware of his mistreatment given his physical condition. He also said that during this time he could hear the screams and pleas for mercy from other prisoners being abused. He told Human Rights Watch,

“I can still hear the voice of one of the guys in my head asking them to stop, saying blood was coming out of his mouth.”

“I can still hear the voice of one of the guys in my head asking them to stop, saying blood was coming out of his mouth.”

In late 2003, Maghrebi was taken to a villa somewhere in Islamabad. After a day and a half, guards blindfolded and handcuffed him and took him to a car. In the car, several people spoke English and Arabic with a broken accent then pushed him down on his stomach. Using apparent CIA rendition transportation procedures, his captors cut off all his clothes, put something in his anus using a plastic applicator, and put him in diapers. Then they put earplugs in his ears, headphones on his head, and bandages all around his head and eyes so he could not see. Then they wrapped adhesive tape all around him. He also felt he was being chained but is not sure. They took him to a plane and threw him in, “like I was a piece of luggage.”<sup>218</sup> Based on the period of time that passed between when they took off and landed, he assumed they had taken him to Bagram in Afghanistan, where the United States was known to be holding many detainees.

### *Afghanistan I*

Maghrebi said that after his arrival in a facility in Afghanistan, he was detained in a few different cells in the facility. Each usually had a thin blanket and a bucket to use as a toilet. His first cell, where he was held for just a short time, was about 2 x 2.5 meters in size. It had a thin mattress when he first arrived, which was taken away after a few days. His cell

---

<sup>218</sup> See text box, “CIA Rendition Transportation Procedures,” above.

had almost no light. He told Human Rights Watch, “[i]t was so dark I couldn’t find the bucket to use as a toilet. I banged my head against the wall.” Loud Western music blared almost constantly the entire time of his detention. At some point, he overheard Shoroeyia and Sharif talking loudly over the music, and they were able to converse a little.<sup>219</sup> He said he was denied food for the first five days after his arrival. He was so sick he called for a doctor, but when the doctor came he behaved like an interrogator. One night the “doctor” stripped him of all his clothes, shackled him to the wall naked, and took away his blankets. Maghrebi said he was left in that position the entire night.

After being held in the first cell, he was taken to a different room and interrogated particularly harshly. He said his interrogators cut off his clothes with scissors, shaved off all his body hair, and put him in diapers.<sup>220</sup> They handcuffed his arms to something above his head and shackled his legs beneath him to the floor. They kept him in that position for what he said felt like about 15 days, only taking him out of the room roughly five times for questioning. He said,

“I was there for 15 days, hanging from my arms, another chain from the ground. They put a diaper on me but it overflowed so there was every type of stool everywhere, the temperature was freezing.”<sup>221</sup>

---

<sup>219</sup> Maqtari recalled that Maghrebi (Adnan al-Libi) was one of the more vocal prisoners who made constant attempts to communicate with his fellow detainees. “I later found out that the person calling was Adnan al-Libi, he had a strong voice. He kept saying ‘number 19, talk to us, number 19’ but I didn’t know that I was number 19 yet.” Amnesty International, *A Case to Answer*, p. 20.

<sup>220</sup> Number 10 on the list of 12 Enhanced Interrogation Techniques (EITs) the CIA requested permission to use was the “Use of Diapers.” See DOJ OPR Report, July 29, 2009, p. 35-36 (The request from the CIA read: “Use of diapers: The subject is forced to wear adult diapers and is denied access to toilet facilities for an extended period, *in order to humiliate him.*” (emphasis added)). The Department of Justice does not appear to have approved the use of diapers as part of the 10 techniques it approved on August 1, 2002. See Office of Legal Counsel, “Memorandum for John Rizzo,” p. 11. See also DOJ OPR Report reference to a “classified Bybee memo” approving 10 techniques. DOJ OPR Report, July 29, 2009, p. 68. However the use of diapers appears to have been approved at some point according to a memo from George Tenet dated January 28, 2003. See CIA Office of the Inspector General, “Special Review: Counterterrorism Detention and Interrogation Activities (September 2001 – October 2003),” May 7, 2004, declassified in August 2009, <http://graphics8.nytimes.com/packages/pdf/politics/20090825-DETAIN/2004CIAIG.pdf> (accessed July 2, 2012), appendix E; See also, Spencer Ackerman, “The Mysterious Eleventh Torture Technique: Prolonged Diapering?” *Washington Independent*, August 24, 2009, <http://washingtonindependent.com/56394/the-mysterious-eleventh-torture-technique-prolongued-diapering> (accessed August 26, 2012).

<sup>221</sup> Maghrebi’s abuse at the facility is corroborated by Bashmilah, who wrote that he heard the screams of prisoner Adnan al-Libi (Maghrebi’s alias). “I began to hear the screams of detainees being tortured there, particularly the prisoner called Adnan al-Libi [Maghrebi]. On their way to the torture and interrogation room, American officials, including ‘Kojak’ [because of his shaved head] would first stop by my cell with a female interpreter and tell me that when I hear people screaming that I



Loud music was blaring constantly. He could touch the floor, but his legs became very swollen while restrained in this position. He said he started having delusions; once he was sure he saw his wife and one of his children in front of him. Sometimes the interrogations that took place during these 15 days were conducted in front of a woman while Maghrebi was naked. They would take his diaper off for these interrogations. The day they released him from detention in this room, they brought him to the showers, chained one arm to the wall and told him to shower. They were watching him, but he could not move his arms to bathe so they had to bathe him.

He said that his next cell was completely dark. He was handcuffed to a steel ring low to the ground, sometimes by one arm so the other arm and both legs were free; sometimes by both arms but legs shackled together; and at times with both arms and legs handcuffed together on the same steel ring. These are the same positions that Shoroeyia and Sharif described being detained in. (See illustrations and descriptions above). Sometimes they would take him to another room and shackle his hands and feet together to the bottom of the table and keep him there for hours. Towards the end of his time in this cell, he was permitted to walk around freely in his cell but with his arms handcuffed and his feet shackled together.

While he was detained, his captors brought him unclean water, for prayers and drinking. “We could see inside the bottles, there was this green fungus,” he said. “Sometimes there would be bugs in my food. Once when this happened it made me cry.”

After one and a half to two months in this third cell, they moved him to a different place. They used the same transfer procedures as they had utilized when transporting him to the first site.<sup>222</sup>

---

should not be afraid because this treatment was just for people who did not cooperate. They told me that they had a way of dealing with people who did not cooperate. I concluded that it was ‘Kojak’ who was so harshly interrogating Adnan al-Libi, because when he came into my cell he would be wearing surgical gloves.” Bashmilah Declaration, para. 70. Maqtari said Adnan al-Libi (Maghrebi) spoke to him when he first arrived, trying to encourage the new detainee to speak. Maqtari was later moved to the cell adjacent to Maghrebi’s. Amnesty International, *A Case to Answer*, p. 19-20.

<sup>222</sup> See text box, “CIA Rendition Transportation Procedures,” above.

“I screamed ‘I want to die, why don’t you just kill me?’”

### *Afghanistan II*

Maghrebi, like Sharif and Shoroeiya, was taken to a second location first by airplane, then by helicopter. He added that they moved him by car from the helicopter to his place of detention. He did not know who else was

with him, but he was counting the chains trying to figure out the number of other prisoners and thought there were about six. At this next location he was put in a cell that was about 2 x 2 meters in size. He was kept naked in this cell, which had a camera and speakers, for about two of the four months he was there. His legs were shackled together, but from time to time his hands were free. He had no mattress but a very small rug that he used at night to try and cover himself up. It was cold. There were other prisoners there and they used to call out to each other. Once he called out to Di’iki (see full case description in later section), who answered him. He was hooded some of the time, but his interrogators would take the hood off during questioning.

Maghrebi told Human Rights Watch that his interrogators spoke English and looked like Americans or Westerners. They had Arabic-speaking interpreters with them, who he believed were Americans from different countries of origin. Though he was not clear about how he knew this, he said one of the interpreters was a woman of Lebanese ancestry and the other two were men, one of Egyptian ancestry and the other of Moroccan ancestry. He counted the number of interrogators and said there were exactly 17.

Maghrebi told Human Rights Watch that he nearly went insane in this cell. At one point he began banging his head against the wall and stopped eating. Reacting to this, guards chained him again to the wall and put cushions on the wall and on the ground that would prevent him from injuring himself. He said,

“I screamed ‘I want to die, why don’t you just kill me?’”

They then restrained him with a belt and started “pretending to be nice,” bringing him a carpet for praying and a Quran. They bathed him, tried to convince him to eat, and took him to a doctor. It was around this time that they told him that they would be taking him someplace else, though they did not say where. This place later turned out to be Libya.

On various occasions while detained in both prisons, he was photographed while naked from many different angles.

### *Transfer and Treatment in Libya*

Maghrebi said he was returned to Libya on August 22, 2004. His American captors prepared him for transport using the exact same procedures that they had employed when moving him from Pakistan to the first detention center in Afghanistan and then from there to his current location. He thought he was going to Guantanamo, but instead they took him to Libya.

Maghrebi was put into what he described as a container and saw Di'iki and Shoroeiya in front of him. After he arrived he was housed in a number of different prisons in Libya over a long period of time. The first prison was Tajoura, where he was held for nine months. There he was beaten and threatened with rape. He was then taken to an internal intelligence building, Amen Dakhali, then another prison on Sikka Road, then Abu Salim prison, then al Nasser bureau, then Ajn Zara (or Enzara), and then again to Abu Salim for the duration of his detention.

After being detained without charge for nearly two years, he was charged in December 2007 with attempting to overthrow the government, summarily tried, and sentenced to 10 years in prison. He said that during his incarceration he was beaten many times, once so badly that he lost a tooth after being punched in the jaw. He was also put into solitary confinement for long periods, though for how long was not clear. He did not have contact with his wife until April 2005. At that time he learned that one of his two sons, age 6, had died. He saw his brother for the first time on July 22, 2006 and learned that his mother had died of cancer four months earlier. Maghrebi was released on February 16, 2011.

## Saleh Hadiyah Abu Abdullah Di'iki

Saleh Hadiyah Abu Abdullah Di'iki (Di'iki)<sup>223</sup> is a former LIFG member who was in US custody before being returned to Libya. He left Libya in 1990, spent time training and fighting against the Soviet-installed Afghan government, and eventually ended up in Mauritania. In 2003 Mauritanian authorities arrested him. Both the Mauritians as well as individuals he alleges were Israeli and American interrogated him. The Mauritanian authorities then transferred him to Morocco, where he believes he was again interrogated by Americans.

US authorities transferred him from Morocco to Afghanistan, where US personnel detained, interrogated, and ill-treated him. The United States eventually transferred him to Libya, where he was detained for years before being tried and sentenced to life in prison. He was released when the uprising against Gaddafi began in February 2011 but then re-arrested shortly thereafter and detained and mistreated until Gaddafi's forces fell that August.

Human Rights Watch interviewed Di'iki over the course of two days in March 2012 in Tripoli and then again by phone from New York in May 2012. The information in this section is drawn from these two interviews unless otherwise noted.<sup>224</sup>

### *Departure from Libya*

Di'iki was born in 1973 and was 17 years old when he left Libya in 1990. He had been studying applied engineering but had not yet finished his studies. He said he left Libya due to abuse and harassment against devout Muslims at the time. He first went to Pakistan and Afghanistan, where he became part of the LIFG, trained in Libyan camps, and participated in fighting against the formerly Soviet-backed government of Mohammad Najibullah. He said that after the Najibullah government fell in 1992, infighting among the different Afghan armed factions made it difficult for Libyans to remain, so he left the country in late 1992 for Mauritania. He said he lived in Mauritania until June 1998 and, while there, pursued religious studies, worked with the LIFG, and got married. He travelled to Syria and then back to the Afghanistan-Pakistan region in 2000. He said that on September 11, 2001

---

<sup>223</sup> Saleh Hadya Abdusalam al-Di'iki's name has been spelled "Salah" or "Saleh De'ayki" and "Abd el-Salam el-Diki." He has also gone by the name "Saad" and "Abu Abdullah al Zlitni," which has been spelled "Abu Abdallah al-Zulaytini".

<sup>224</sup> Human Rights Watch interview with Saleh Hadiyah Abu Abdullah Di'iki, Tripoli, Libya, March 17 and 18, 2012 and phone interview, May 24, 2012.

he was in Karachi, Pakistan. After the attacks, he went to Iran via Afghanistan, then to Malaysia, and then back to Mauritania.

### *Arrest and Detention*

Mauritanian authorities arrested Di'iki on October 12, 2003 and took him to the headquarters of the main military intelligence agency, where he was interrogated for two to three weeks. He said that after two weeks, the Mauritanian authorities informed him that they had no problem with him but that the Americans wanted him detained. Then a second group of interrogators came. They spoke Arabic but did not seem to be Mauritanian. He said a Mauritanian official told him that these interrogators were Israeli. They took him to a villa, which was called Kufra Zeina, asked him many questions about Israel, and accused him of planning to use his car to blow up the Israeli embassy in Mauritania. Di'iki called these allegations "ridiculous." Then he was taken back to military intelligence headquarters where the senior official there, Abdullah, told him that someone from the United States had come to ask him some questions. Di'iki said that the American, who spoke to him in French, was perhaps under 30, of medium height, with white skin and blond hair, and wearing glasses and military boots. The man questioned him for one day. Di'iki remained at the military intelligence building for another two weeks.

One day at noon, Mauritanian authorities handcuffed him and took him to the airport. They told him he was being taken to Morocco because he had a Moroccan passport. He said the Mauritanian authorities were well aware he was Libyan. He had told them he only had a Moroccan passport because he could not get a Libyan one. At the airport there was a small Fokker aircraft for 14 passengers waiting for them. When he arrived in Morocco, Moroccan agents took him to a prison where he said there were a lot of names on the walls of people who were eventually taken to Guantanamo. One he remembers was a Yemeni, Ramzi bin al-Shibh.<sup>225</sup> Di'iki told Human Rights Watch, "He had written on the wall, 'For the one who is going to read this, I am Ramzi bin al-Shibh and for anyone who can read these lines, I

---

<sup>225</sup> Ramzi bin al-Shibh is currently in Guantanamo. He is one of five accused, in addition to Khaled Sheikh Mohammed, of planning and orchestrating the September 11 attacks. After his arrest in September 2002, he was forcibly disappeared into secret CIA custody, his whereabouts not known to the public until September 2006 when President George W. Bush announced his transfer, along with 13 other detainees, to Guantanamo. For evidence that bin al-Shibh was in Morocco at this time, see Matt Apuzzo and Adam Goldman, "CIA flight carried secret from Gitmo," *Associated Press*, August 6, 2010, <http://www.utsandiego.com/news/2010/aug/06/ap-exclusive-cia-flight-carried-secret-from-gitmo/> (accessed August 22, 2012).

ask him to please inform my family in Yemen that I believe that on this date \_\_\_\_ I will be transferred to Guantanamo tomorrow.” Di’iki could not remember the date. Another was Kuwaiti, but he couldn’t remember his name.

In Morocco, Di’iki was detained for about one month. He said his detention conditions were not that bad. His cell was made of stone, had a window and a mattress on the floor. “If you want to compare it to the other places I was later held,” he said, “it was five stars.” He was able to communicate with one other prisoner, Abu Omar al-Maghrebi.<sup>226</sup> The others were too afraid to talk. Abu Omar al-Maghrebi confirmed that he was in Morocco, but the food and the guards who identified themselves as Moroccan and spoke Arabic with a Moroccan accent also made this clear. Di’iki and Abu Omar al-Maghrebi would signal by banging on the walls that it was safe to speak and then they would whisper to each other through the wall very carefully so as not to be heard. Abu Omar al-Maghrebi said he had come from Guantanamo and that all the prisoners where the two of them were being held at the time seemed to be taken to either Guantanamo or Bagram.

Di’iki said that in Morocco he was interrogated by a woman who he believes was American. She was tall, blonde, with light green eyes, about 35 years old, and wore civilian clothes and the same type of military boots that the American interrogator in Mauritania wore. She spoke with an American accent and used a female Tunisian interpreter. She interrogated him about four or five times over the course of about two weeks. He said she was continuously angry with him. He was blindfolded in the beginning, but then she had the blindfold removed, saying that she was not afraid of “you Arabic people.” When he asked if he could call his wife, who was seven months pregnant, the interrogator accused him of being insensitive to the crimes that “his people” had committed.

After a month, his guards took him to a place where he could hear a plane. This was sometime in early January 2004, possibly January 7. Another detainee was there—he could hear him walking—and he counted six American guards. They used mainly sign language, but sometimes they said a word or two in English, which they spoke with an American accent. They wore military uniforms with American flags on them and had masks on their

---

<sup>226</sup> The name Abu Omar al-Maghrebi indicates in Arabic that he is from Morocco. While al-Maghrebi means “the Moroccan one,” it does not necessarily mean he comes from there.

faces. He said he saw from the eyeholes cut out of their masks that two had light skin and one had dark skin.

They told him to bathe, and if he didn't do it himself, they said they would bathe him. His Moroccan handcuffs were removed and he was re-handcuffed and his legs shackled. They cut off all his clothes using scissors. He told Human Rights Watch,

“I was totally naked...Then they did horrible things to me that I can't talk about. They didn't rape me but they did terribly humiliating things.”

“I was totally naked...Then they did horrible things to me that I can't talk about. They didn't rape me but they did terribly humiliating things.”

Then they diapered him, put patches over his eyes, plugs in his ears, and a hood over his head. Then they wrapped him in what he described as adhesive tape all around his head. He said every time they moved him to a new place they went through this same procedure.<sup>227</sup> Then they took him to the plane and threw him in the back. They lay him on one side and bound him by rope. It was a very long trip and from time to time someone he believed was a doctor would come around and put something on his finger, which appeared designed to check his pulse. The person also examined his nose.

### *Afghanistan I*

Di'iki said that after arrival he was put in a cell approximately 2 x 2 meters. The cell was one of approximately 15 to 20 that were in a big hangar. His was “very simple,” with no paint on the walls and iron doors. He was handcuffed and his feet shackled for one month. After that he was attached by one arm to a steel ring attached to the wall of his cell, the position described by Shoreiyya, Sharif, and Maghrebi.

He said a number of factors led him to the conclusion that he was in Afghanistan. Even though the guards wore masks and rarely spoke to him, sometimes they wore traditional Afghan clothes and they fed him Afghan food.<sup>228</sup> The Afghan bread specifically, he said, is

---

<sup>227</sup> See text box, “CIA Rendition Transportation Procedures,” (above).

<sup>228</sup> Di'iki also said some guards wore a mix of traditional “Afghan clothes and army shirts.”

“At that moment, if I had found anything in Sharia [Islamic law] that would have allowed me to commit suicide, I would have done it. But there is nothing. Suicide is prohibited in our religion.”

very distinctive. Also, though they clearly were not supposed to, some of the guards spoke to him in Pashto.<sup>229</sup> Sometimes he could see a little bit of their beards, too. After some time, they began to take him out once a week for about 15 minutes of exposure to sunlight. When they did this it was usually around noon. They would stand him in front of a wall, and on several occasions he could hear children playing nearby, speaking in Pashto.<sup>230</sup> At some point, his captors asked him where he thought he was. He told them Afghanistan and said he could tell because of the texture of the soil and the structure of the buildings.<sup>231</sup>

Other than the brief outdoor sessions and weekly baths that he was allowed to take after some time, his captors only took him out of his cell to interrogate him. Much of this time he was kept naked, though it is not clear for how long. He went on a hunger strike over this, asking only for clothes because he said it is forbidden in Islam to pray while naked. He said,

“At that moment, if I had found anything in Sharia [Islamic law] that would have allowed me to commit suicide, I would have done it. But there is nothing. Suicide is prohibited in our religion.”

There was a loudspeaker over his head that played loud Western music continuously. He said, “Even if the music they were putting on was something nice, you would end up hating it because they were playing it so loud.” It was dark almost all the time, but every now and then the lights would come on—he thought usually because of some power failure or other malfunction.

---

<sup>229</sup> Once he asked one of his guards in Pashto the direction of Mecca and the guard answered back in Pashto.

<sup>230</sup> Bashmilah described similar “sunning” sessions, where he was placed in front of a wall outside and he could hear children playing and speaking Pashto nearby. See Bashmilah Declaration, paras. 73-74.

<sup>231</sup> Khaled al-Maqtari said he spoke to someone who was in cell 20 during his detention in Afghanistan that appears to be Di’iki. The prisoner in cell 20 went by the name Sheikh Saleh al-Libi (a version of Di’iki’s first name indicating he is from Libya). Maqtari said “Saleh al-Libi” told him he had been detained in Mauritius and rendered through Morocco to their current place of detention. However, it is possible the connection with Mauritius is mistaken and was actually Mauritania where Di’iki was initially detained. See Amnesty International, *From Abu Ghraib to Secret CIA Custody: The Case of Khaled al-Maqtari*, p. 20.



His interrogators would come to him with flashlights. He believes his interrogators wore civilian clothes but had military boots on and the American guards wore military uniforms. Several of the interrogators were female. They all spoke English and used interpreters. He thought some of these interpreters were American as well because their Arabic had a strong American accent.

Di'iki described his cell as rat and insect infested. "We know most rats are afraid of humans but these ones were so irreverent, going all over my head and body," he said.

He told Human Rights Watch that this was the first time he had described his confinement in detail and that in doing so he felt a sense of relief. He was not sure he could adequately convey the abuse he received:

"They were taking good care to harm me with psychological abuses. The concentration was on humiliating me. It was not really physical abuse.... What they did to me was so humiliating I am not sure I can explain it properly—especially forcing me to be naked."

Sometimes when the music was low, he would speak to other prisoners. He remembers speaking to Shoroeiya, Maghrebi, and Sharif. He also heard the voices of two people from Yemen and one from Algeria, but he did not remember their names. He said their voices seemed like they were close to him. Shoroeiya and Maghrebi, he said, were both on his plane back to Libya in August 2004.

### *Afghanistan II*

Di'iki said that after four months in the first place of detention, he was moved to another location. This would have been sometime in late April 2004. When they moved him, they

"They were taking good care to harm me with psychological abuses. The concentration was on humiliating me. It was not really physical abuse.... What they did to me was so humiliating I am not sure I can explain it properly—especially forcing me to be naked."

used the same CIA rendition transportation procedures that were used before.<sup>232</sup> He was then taken to the next location either by helicopter or plane or both, he could not remember. He did not know who else was on the flight with him. They arrived at night, which he could tell because they took off his hood and blindfold.

In this location they seemed to be making a lot of effort to get him to think he was no longer in Afghanistan. They brought in different kinds of non-Afghan food in cans. He told Human Rights Watch, “I find it very strange that the Americans were so intent on obscuring the fact that I was in Afghanistan. In the second place they tried to change the entire set up and I don’t know if it was just for me or for everyone else but they even tried to change the food, they gave me canned food, to try and obscure the fact that I was in Afghanistan.”

Nevertheless, Di’iki said he could tell he was still in Afghanistan by the guards, who on one or two occasions accidentally spoke to him in Dari. His cell was bigger than it was in the other location, though still about 2 x 2 meters, but unlike the first location there was not a lot of distance between each cell. The structure was more like a building and was much bigger and newer. The first place was much simpler, less polished, and seemed to be an older facility, made out of mud, bricks, and stones.

His cell in the second facility was gray, including painted concrete floors that had a lacquer finish. His cell had two doors, one in front of the other. His feet were shackled the entire three to four months he was there, but not to the wall, so he was able to walk around. Occasionally, his hands were cuffed as well. There was a camera in his cell in this second location. In the middle of the room there was a hole connected to a sewage line so his whole cell smelled every time a toilet flushed. There was loud music playing constantly, but it seemed to be mostly outside his cell, not inside. They also played other sounds, like the sound of water dripping or the sound of an electric shock. They would use the loud electric shock sound sometimes to wake the detainees up.

For his first few weeks in the new facility he was kept naked. They gave him just one blanket that was very rough. He described it as being “like from World War II. When I tried to use it, it was so prickly, it was like getting acupuncture.” There was no mattress.

---

<sup>232</sup> See text box, “CIA Rendition Transportation Procedures,” (above).

He again went on hunger strike, asking for clothes, a mattress, a different cell, and to be told the direction of Mecca for prayer. He said he was also very sick during this time, but “by the grace of God,” managed to sleep about three quarters of the time. Sometimes a doctor would come in to check on him, picking up an arm or a leg. He has a thyroid gland problem that requires medication and rest but he did not tell anyone about it because he was afraid they would use it against him. Before his detention he weighed between 95 and 100 kilos (209 and 220 pounds) but by the time he arrived back in Libya, he was 70 kilos (154 pounds), a loss of some 25 to 30 kilos (approximately 55 to 66 pounds). He is about 185 centimeters tall (approximately 6 feet 1 inch).

“When you are in a place like this ... when you are alone and talking to no one, life is stopped. Nothing is new. The only thing new going on is the interrogations.... I can guarantee they have studied psychology very well.”

He said he faced fewer questions and interrogations in this second location. The interrogators, who he believed were Americans, would mostly just bring him photographs, asking him if he knew the person in them and some questions about the people in the photos. As in the first location, the interrogators wore civilian clothes. There again were American guards in military uniform, but they appeared to play more of a supervisory role over the Afghan guards, who at this location wore all black with facemasks rather than traditional Afghan clothes.

Although the interrogations were less intensive, he felt that time in this location was more difficult from a psychological perspective because of the isolation. It was more difficult to communicate with others and detect the passage of time. This and the lack of knowledge about his future—how long he was going to be there and what they were going to do to him—made his time in this facility very difficult:

“When you are in a place like this ... when you are alone and talking to no one, life is stopped. Nothing is new. The only thing new going on is the interrogations.... I can guarantee they have studied psychology very well.”

“When I realized I was being sent back to Libya, I thought they would hang me by my tongue. There was a guy from the east that died that way and I was sure, because of what I had been writing and saying about the regime, I would die that way too.”

Di’iki said that despite the circumstances, it was possible to find some humanity. He could tell that the interpreter used by a doctor did not agree with the way he and the other prisoners were being treated and once got into an argument with the doctor over it in front of Di’iki. “This young man, every chance he got, he would try and throw a smile or a joke my way,” Di’iki said, “trying to cheer me up, show me some kindness.” He still appreciates this small show of support from the interpreter.

### *Transfer and Treatment in Libya*

Di’iki said one day, which he later learned was August 22, 2004, his captors told him he would be transferred the following day, but did not say where. He thought he would be taken to Guantanamo. They took off his metal handcuffs and put on plastic ones. Prior to that, however, they put him through the same CIA rendition transportation procedures<sup>233</sup> as they had on previous occasions, except this time, the man he believed was a doctor took photos of him while he was naked. Then they put him in a shipping container.

For a moment his blindfold was taken off and he saw Shoroeiya on the floor of the container. On the plane back to Libya he could tell that he was sitting next to someone but did not know whom. It was not until he heard the driver say “back up” using the Libyan word derived from Italian, *indietro*, that he realized he was in Libya. He told Human Rights Watch,

“When I realized I was being sent back to Libya, I thought they would hang me by my tongue. There was a guy from the east that died that way and I was sure, because of what I had been writing and saying about the regime, I would die that way too.”

Upon arrival his blindfold was removed and he was put in a car with Maghrebi in which he was driven to Tajoura prison.

---

<sup>233</sup> See text box, “CIA Rendition Transportation Procedures,” above.

Di'iki was detained in solitary confinement at Tajoura until May 2005. Then he was taken to Ain Zara, where he remained for 13 months. Then around June 2006 he was moved to Abu Salim, where he remained for the duration of his detention. He was not physically abused while in detention in Libya. While detained in Ain Zara, he saw his wife for the first time since his return. Following that visit he had no family contact for about two years. When he was moved to Abu Salim in 2009, however, the visits became more regular.

After being detained without trial for years, Di'iki was charged with attempting to overthrow the government and, after a summary trial, was sentenced to life in prison. He was released on February 16, 2011 when the uprisings against Gaddafi began but was arrested again on June 18, 2011 and held until Tripoli fell to rebel forces on August 24, 2011. He said this last period of detention was the worst he experienced in Libya. He was beaten repeatedly. A man came and broke a broom over his head, and he was forced to be naked. He was in a cell with three other prisoners that was smaller than 2 x 2 meters, including the toilet. Human Rights Watch did not find out when he was finally released. Now Di'iki works with Khalid al-Sharif at the Libyan National Guard. Both he and Sharif are in charge of security at facilities holding high value detainees (mostly officials of the former Gaddafi government) in Libyan government custody.

One of the Tripoli Documents, found in the folder marked "USA" and containing a number of faxes apparently from the CIA, mentions Di'iki in the context of an offer to transfer his supposed deputy, "Mustafa Salim Ali Moderi Tarabulsi, aka Shaykh Musa" to Libya. Mustafa Salim Ali Moderi Tarabulsi or Shaykh Musa's real name is Mustafa Salim Ali el-Madaghi. Human Rights Watch interviewed Madaghi for this report as well.<sup>234</sup> The document where he and Di'iki are mentioned is dated April 15, 2004 (see below). It appears to have been sent by the CIA to Libyan security.<sup>235</sup>

By then Di'iki had already been picked up in Mauritania, moved to Morocco, and was being detained in the first location in Afghanistan.

---

<sup>234</sup> Human Right Watch in interview with Madaghi, Tripoli, Libya, March 26, 2012.

<sup>235</sup> Pasted here but see also Tripoli Documents 2142.

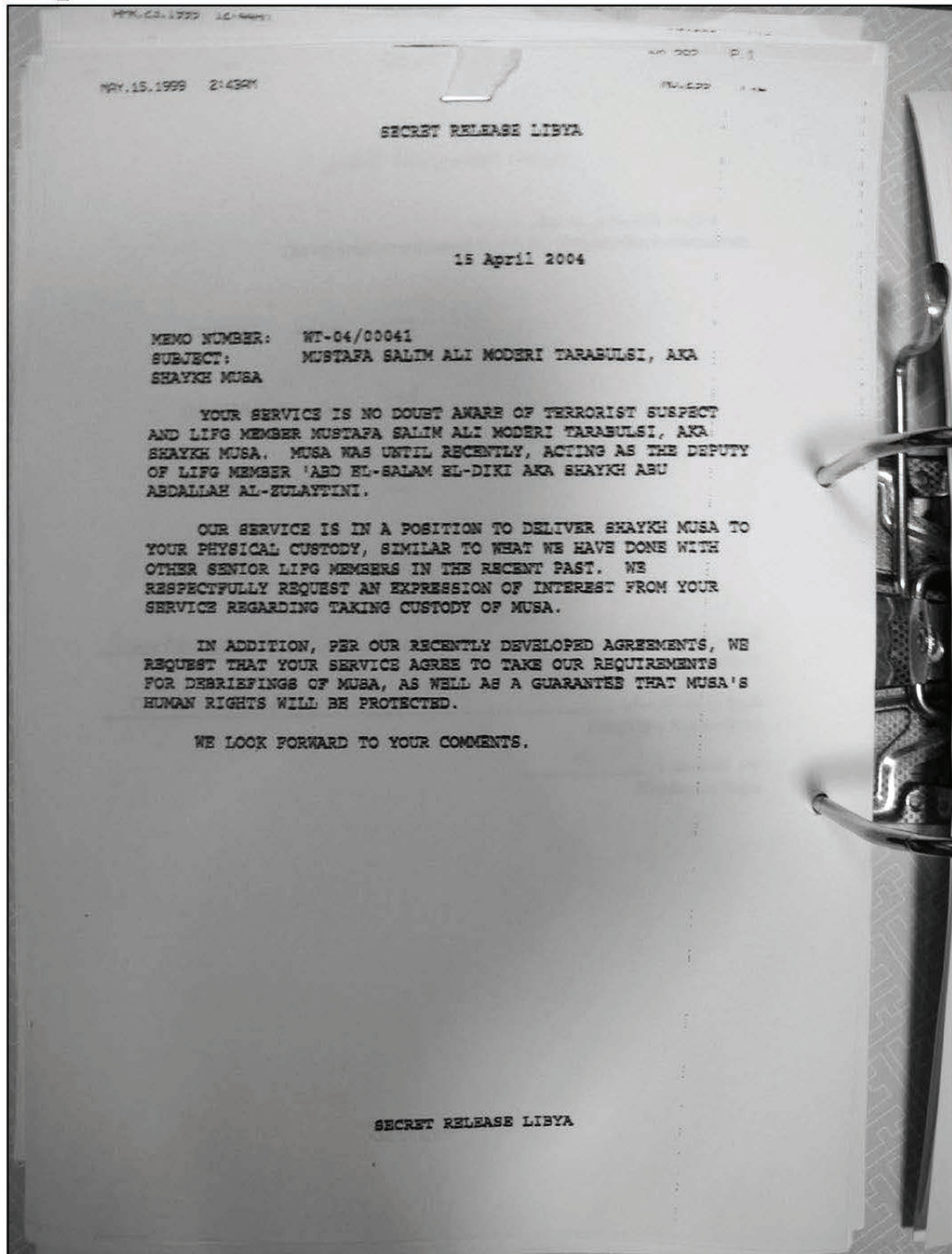

Tripoli Document 2142 © 2012 Human Rights Watch

## Mustafa Salim Ali el-Madaghi

Mustafa Salim Ali el-Madaghi (Madaghi)<sup>236</sup> was an LIFG member who said he left Libya in 1990. He was arrested in Mauritania and coercively interrogated by someone he believes was American. As the Tripoli Documents indicate, US authorities later transferred him to a prison in Morocco, where he was held for a month and then returned to Libya. In Libya he was charged with trying to overthrow the government, given a summary trial, and then sentenced to life in prison. This sentence was later reduced to seven years, then to four, but he remained in custody after the four years were up, until the uprising against Gaddafi began on February 16, 2011.

Human Rights Watch interviewed Madaghi in Tripoli in March 2012. The information in this section is drawn from this interview unless otherwise noted.<sup>237</sup>

Mustafa Salim Ali el-Madaghi said he left Libya in 1990 because of religious oppression. He joined the LIFG in Afghanistan, spent time in Sudan, and finally ended up in Mauritania. He was arrested in Mauritania on February 5, 2004, where he was living with his wife and children. He told Human Rights Watch that the Mauritanian intelligence service took him to a detention facility, but no interrogations began until a group of foreigners arrived about two days later. The foreigner who led the interrogations spoke Arabic with a Lebanese accent and was dressed in civilian clothes. He was joined in one interrogation session by the head of Mauritanian intelligence and a Mauritanian interrogator named Ismael. Madaghi believes the foreigner was American because he asked about threats to the United States, talked on the phone in English, and sent text messages in English on his cell phone.

The foreign interrogator in Mauritania questioned Madaghi for about 10 days. He wanted Madaghi to confess to being part of al Qaeda, to give up the location of a man named Abdul Rahman, and to describe the next attacks being plotted against the United States.<sup>238</sup>

---

<sup>236</sup> Mustafa Salim Ali el-Madaghi's name has been spelled "Mustafa Salim Ali Moderi Tarabulsi" (Tarabulsi meaning "from Tripoli") and he has also gone by the name "Shaykh Musa," sometimes spelled "Sheikh Musa." He served as the deputy of Di'iki in Mauritania for the LIFG.

<sup>237</sup> Human Right Watch interview with Madaghi, March 26, 2012.

<sup>238</sup> Abdul Mohammed Omar al-Tawaty is another Libyan interviewed for this report who was in Mauritania at the time and went by the name of Abdul Rahman (see below).

The interrogator also asked him if he knew people in al Qaeda as well as other questions about Libyans in the United Kingdom. Madaghi said he explained that he was with the LIFG, not with al Qaeda.

Madaghi said that the foreign interrogator threatened him throughout the interrogations. He told Madaghi that harm would come to his wife and family if he did not provide the answers he wanted. His captors brought his wife to the detention center, showed her to Madaghi through a keyhole, and threatened to rape her if he did not cooperate. They also warned that his children would be orphaned. They went to his home and returned with recordings of his children's voices for him to hear and then threatened their safety. The language used by the foreign interrogator was full of derogatory and obscene sexual comments.

After two weeks another foreigner, who Madaghi said appeared more European than the alleged American interrogator, administered a lie detector test that Madaghi said he passed. He thought this might be the end of his detention, but then he was taken to a different facility in Mauritania.<sup>239</sup> In total, Madaghi was detained in Mauritania from February 5, 2004 until sometime at the end of March 2004.

### *Morocco*

Madaghi told Human Rights Watch that one night around midnight, he was taken abruptly from the detention center in Mauritania and put on a bus. He was blindfolded and his hands were bound, but he could see the feet of the people holding him. At some point all the Mauritians got off the bus and others, wearing boots, got on. They took his blindfold off and he saw that he was now in the custody of several large men, perhaps five or six. He knew that he had been taken to the airport.

He believed the men who boarded the bus were Americans. They were wearing black and had masks on their faces; through the eyeholes he could see fair skin and eyes and light eyebrows. They were careful not to say very much, but he could hear some English. His belief that they were American was confirmed by the Tripoli Documents and his subsequent detention at a facility in Morocco that appeared to be run by Americans. While on the bus they took off all of his clothes; inspected his eyes, ears, and mouth with a device;

---

<sup>239</sup> This would be sometime in early March.



took photos of him; put him in diapers; covered his ears with headphones; put a hood and blindfold around his head very tightly; and bound both his feet and hands together—the standard CIA rendition transportation procedures.<sup>240</sup> He was then put on a plane, though they did not tell him to where.

Upon landing, his guards put him in a cell that had Arabic poetry written all over the walls. The guards would repeat phrases glorifying the king of Morocco. Because once he heard Moroccan military training exercises going on outside, he concluded the detention facility was either inside or near a military base.

The interrogations occurred intermittently and were conducted by Moroccans. Madaghi said that they asked essentially the same questions that the interrogators in Mauritania had but added more questions about Europe and other LIFG members such as Belhadj and Saadi. They often threatened to beat him, but never actually did. Madaghi said his cell was freezing cold. They also left him barefoot, bathed him in ice cold water, and clothed him in short-sleeve shirts and knee-high pants. He was kept in a cell that was below ground level, but there was a small window that allowed him to see some light. With that and the sound of the call to prayer, he was able to keep track of the number of days he was detained there—about one month and five days. He did not speak to any other prisoners while there, but there was a Moroccan woman in the cell across from his who would scream from time to time. He could also hear other prisoners shouting and screaming. Occasionally, late at night he would hear cars arriving, doors slamming, and the sounds of new prisoners being brought in.

On April 14, 2004, according to the date on document from the CIA, the CIA informed Libyan authorities that they were in a position to “deliver” Madaghi, who was then in a prison in Morocco.

### *Transfer and Treatment in Libya*

On May 5, 2004, Madaghi was taken away without notice in the middle of the night. They blindfolded him and put him in a car. Because it was clear they were moving him again, he begged them not to send him back to Libya.

---

<sup>240</sup> See Text Box, “CIA Rendition Transportation Procedures,” (above).

“He asked me: ‘Do you know who brought you here?’ I didn’t want to say anything. He said ‘The Americans brought you here. It’s all over now. There is cooperation between us and the Americans.’ I was sure that was the case, but then he just confirmed it for me.”

They drove for what felt like a very long time. Then they put him in a place where he was left alone. He said he was again put through the same CIA rendition transportation procedure as before.<sup>241</sup> He was able to loosen the headphones a bit this time, and though he was beaten for it, they did not tighten the headphones again, so he was able to hear a little. Then they put him in another car and drove him to a plane. They put him in the plane, but this time he was bound to a chair instead of to a bed. He said the flight took a very long time. Every now and then someone would come around and put something on his finger to check him. They stopped someplace to refuel. He could tell they were at an airport because he could hear other planes, and he could tell they were refueling because he felt the movement of the refueling machinery.

Because the flight took so long, he was sure he was being taken to Guantanamo, but in fact he was taken to Libya.

Madaghi told Human Rights Watch that Musa Kusa came to see him about two weeks after he arrived:

“He asked me: ‘Do you know who brought you here?’ I didn’t want to say anything. He said ‘The Americans brought you here. It’s all over now. There is cooperation between us and the Americans.’ I was sure that was the case, but then he just confirmed it for me.”

Some Eurocontrol flight data on file with Human Rights Watch corroborated Madaghi’s belief that the United States rendered him to Libya. The flight data states that a CIA-linked Gulfstream V, registration N8068V (formerly N379P), used in other CIA renditions,<sup>242</sup> filed a

---

<sup>241</sup> See text box, “CIA Rendition Transportation Procedures,” above.

<sup>242</sup> The aircraft N8068V/N379P was owned from 2001 to at least 2004 by a US company called Premier Executive Transport Service (Premier) and operated by pilots employed by Aero Contractors Ltd. (Aero) in Smithfield, North Carolina—companies with known ties to the CIA. Joby Warrick, “Ten years later, CIA ‘rendition’ program still divides N.C. town,” *Washington Post*, February 9, 2012, <http://www.washingtonpost.com/world/national-security/ten-years-later-cia-rendition-program-still->

flight plan to go into Nouakchott, Mauritania on March 25, 2004 at 1:22 am local time (from Washington, DC, via the Canary Island of Tenerife, presumably for refueling). This is around the time that Madaghi said he was taken to Morocco. The data also shows a plan was filed to fly out immediately to Rabat, Morocco, at 2:34 am, and to land in Rabat at 4:52 am. The pilots then filed a plan to return to Washington (again, via Tenerife). The same Eurocontrol flight data on file with Human Rights Watch also shows that CIA-linked Gulfstream IV, registration N85VM, used in other CIA renditions,<sup>243</sup> filed a flight plan to go into Rabat on May 4, 2004 (from Washington via Palma Majorca), arriving at 10:52 PM, and then to Misrata in Libya. The flight appears to have stopped and refueled at a military airport in Italy en route to Misrata on or about May 5, 2004—the same day that Madaghi said he was returned to Libya by the US.

Madaghi said he was not physically abused in Libya but that his conditions of confinement were still very difficult. He was first held in Tajoura prison for about one year, in solitary confinement in a 1.8 x 1.8 meter cell. He was not allowed to speak to any other prisoners during this time. He was then moved to Abu Salim for a few weeks, where he said the conditions were worse than Tajoura and the cell smaller. He was then taken to al Nasser bureau for another few weeks. He said his cell there was the worst of all: very dirty and tiny, about the size of a mattress. It had no windows and no bed, just a blanket on the concrete floor. He was then in Ain Zara for another year, from May 2005 until June 2006, and finally in Abu Salim for nearly five more years. After two years in detention, he was charged with trying to overthrow the government, given a summary trial, and then sentenced to life in prison. This sentence was later reduced to seven years, then to four, but he remained in custody after the four years were over. He was not released until the uprising against Gaddafi began on February 16, 2011.

---

divides-nc-town/2012/01/23/gIQAwrAU2Q\_story.html (accessed August 28, 2012); See also “Europe: Pending Questions on CIA Activities in Europe,” Human Rights Watch news release, February 21, 2006, <http://www.hrw.org/news/2006/02/20/europe-pending-questions-cia-activities-europe>.

<sup>243</sup> The airplane N85VM has been firmly linked to the rendition of an Egyptian cleric, Abu Omar, from Italy to Egypt in 2003, via the US military base in Ramstein, Germany. Eurocontrol data reveal that the airplane traveled from Ramstein Air Base in Germany to Cairo on February 17, 2003, precisely the same date that Abu Omar was transported from Germany to Egypt. See Peter Finn and Julie Tate, “N.Y. Billing Dispute Reveals Details of Secret CIA Rendition Flights,” *Washington Post*, August 30, 2011, [http://www.washingtonpost.com/world/national-security/ny-billing-dispute-reveals-details-of-secret-cia-rendition-flights/2011/08/30/gIQAbggXsJ\\_story.html](http://www.washingtonpost.com/world/national-security/ny-billing-dispute-reveals-details-of-secret-cia-rendition-flights/2011/08/30/gIQAbggXsJ_story.html) (accessed July 31, 2012). The N85VM aircraft and its use by the CIA was the subject of several earlier media investigations. See, for example, John Crewdson and Tom Hundley, “Jet’s Travels Cloaked in Mystery,” *Chicago Tribune*, March 20, 2005, [http://articles.chicagotribune.com/2005-03-20/news/0503200504\\_1\\_31st-fighter-wing-suspects-abu-omar](http://articles.chicagotribune.com/2005-03-20/news/0503200504_1_31st-fighter-wing-suspects-abu-omar) (accessed July 31, 2012).

## Mustafa Jawda al-Mehdi



Mustafa Jawda al-Mehdi  
© 2012 Human Rights Watch

Mustafa Jawda al-Mehdi (Mehdi)<sup>244</sup> was an LIFG member who left Libya in 1989. He first went to Saudi Arabia, then to Afghanistan and Pakistan. He was arrested in Pakistan in 2004 by persons he believed were with the Pakistani intelligence services. He alleged he was interrogated multiple times and in multiple locations by the same set of American interrogators. Subsequently, he was transferred to Afghanistan, where he said US personnel detained, interrogated, and mistreated him and then rendered him to Libya. In Libya he was subjected to prolonged solitary confinement in multiple places of detention. After a summary trial for his involvement with the LIFG, he was sentenced to death. He was released from prison on February 16, 2011.

Human Rights Watch interviewed Mehdi in March 2012 in Tripoli and then again by phone from New York in June 2012. The information in this section is drawn from these two interviews, unless otherwise noted.

### *Departure from Libya*

Mustafa Jawda al-Mehdi was born in Tripoli in 1965 and left Libya in 1989 at the age of 24. He had been working as an administrator at the al Brega Oil Company. He said he left Libya because of the religious persecution going on at the time: “Anyone who was committed to Islam, who attended mosque five times a day, especially youths, was committing a crime—especially those who dressed in a certain way, had a beard for example. It didn’t matter which school of Islam you belonged to, just that you were devout.” About 30 of his friends had been arrested, he said, and the authorities were coming to his home asking questions, so he felt threatened. Many of his friends were later imprisoned and killed in the 1996 Abu Salim prison massacre.

---

<sup>244</sup> Mustafa Jawda al-Mehdi has also had his name spelled “Al Mahdi Mostafa al-Mahdi Gouda,” “Mahdi Jawda,” and “Al Ahdi Mostafa Al Mahdi Gouda.” He also went by the names “Abd al-Wahed,” “Abu Ayoub,” and “Ayoub al-Libi.” Sometimes Ayoub was spelled “Ayyub” or “Ayub.”

Mehdi said he first went to Saudi Arabia “just to get out of Libya—to survive.” But once there, he found that many people were going from there to Afghanistan and that it was very easy to do so. He followed suit. It was in Afghanistan and Pakistan that he first became involved with the LIFG. He stayed in the area, met his wife in Peshawar, married in 1993, and remained in Pakistan until 2004.

### *Arrest and Detention*

On February 23, 2004, when Mehdi was travelling on Kohat Road about 10 minutes outside of Peshawar, around 20 cars suddenly surrounded his vehicle. He was arrested by men that Mehdi believed were members of the Pakistani Inter-Services Intelligence (ISI), because he recognized their uniforms. Two other people with him were also arrested, but the authorities were clearly just interested in him, as they asked for him specifically by the name he was using at the time, “Ayoub.”

Documents found in Musa Kusa’s office, in a binder marked “UK,” indicate that the British intelligence service MI6, also referred to as SIS, was looking for Mehdi (noting that he was born in 1965 in Tripoli) at some point after January 29, 2003.<sup>245</sup>

### *Peshawar*

Mehdi said he was detained in Peshawar for about 40 days at the Army Stadium in the military area. He told Human Rights Watch that on that first day in detention, the interrogations were initially just done by the Pakistani ISI, but by noon Americans were present. He said he knew they were Americans because when they came, they put a hood over his head, used an interpreter, and asked questions solely about the United States. He said the same interrogators who questioned him in Peshawar later questioned him in Islamabad and after that, in Afghanistan, where he was in US custody for 10 months. During those later interrogations, he was not forced to wear a hood and could see their faces.

While in Peshawar, Mehdi was interrogated about seven to ten times by an American woman, using an interpreter. He said he was later able to tell that the interrogator had blond hair and green eyes, was of medium height, and was likely in her thirties. He was not

---

<sup>245</sup> Tripoli Document 2220.

physically abused in Peshawar, but he said the food was bad, the lights were on all the time, there was just a mat on the floor, he was alone in the cell, and they threatened to bring his wife there and rape her. Although he was not physically harmed, he heard other people screaming in the basement.

### *Islamabad*

After about 40 days in Peshawar, Mehdi said he was taken to Islamabad, where he was held for another two and a half months. Approximately 8 to 10 other prisoners were there. After about two weeks, the same American woman who interrogated him in Peshawar did so in Islamabad as well. She interrogated him several times with an interpreter. One of these times there was another woman there who was young, in her twenties, had black hair, and had some sort of malformation in her teeth. His face was not covered during these interrogations.

Mehdi said he was physically assaulted by Pakistani authorities numerous times. Sometimes they beat him using a broomstick on various parts of his body and other times they slapped him. They also forcefully took away his clothes, leaving him naked. No beatings occurred in the presence of US interrogators, he said, but the Pakistanis told him they had “no problem with him, it was the US that had the problem.”

The first time he saw his American interrogator in Islamabad, he told her the Pakistanis were beating him but she accused him of lying. She kept threatening to take him to a place where he would “begin talking right away” if he did not begin to provide more information. She kept insisting that he had been living in Waziristan, along Pakistan’s border with Afghanistan in its Federally Administered Tribal Areas, and knew people there, but he said had been living in Peshawar and was only on his way to Waziristan when he was arrested.<sup>246</sup>

### *Afghanistan*

Mehdi said that one night in June the guards entered his cell, told him he was leaving, and drove him—handcuffed and with his face covered—to an airport about 15 minutes away. On the plane there were both American and Pakistani guards, but when he spoke Urdu, the

---

<sup>246</sup> Mehdi said it was not safe in Peshawar anymore, so he sent his family to Waziristan ahead of him and was on his way there to meet them when he was arrested.

Pakistanis responded in Pashto. He thought other prisoners were there with him, but he was not sure. They landed after about half an hour at what he believes was Kabul or Bagram. He told Human Rights Watch,

“I was scared. I knew that the worst was coming now. I knew I was going to face worse than what I had before. It was true. I was right. That’s when the nightmare began.”

“I was scared. I knew that the worst was coming now. I knew I was going to face worse than what I had before. It was true. I was right. That’s when the nightmare began.”

He said that at the detention facility, two people took him to a cell, put his hands up against the wall, and then cut off his clothes with scissors. They put his bare feet in shackles and then chained him by one arm to the cell wall. His arm was positioned so that the bottom of his elbow was just about four fingers from the floor. He could stand up but only by bending over, forcing him to either sit or lie down. “It was like torture in medieval times,” he said. He remained in this position, totally naked, for about two months. After two months his captors gave him some pants and, a month later, a shirt. After the fifth month, they stopped handcuffing him to the wall and he was able to move around inside his cell.

The guards there were all wearing what he described as “black special forces” uniforms. They were masked and wore black jackets that had four pockets in the front. They wore black boots made out of a Gore-Tex-like fabric and black gloves. He thinks the guards were a mix of Americans and Afghans, but he could not be sure. They never spoke to him, but only communicated with signs and signals. Sometimes when his cell door was opened to bring him food, he would hear guards speaking in English. And when he was taken out of his cell for washing, he sometimes heard Dari- or Pashto-style music coming from what he believed were the guards’ rooms.

His cell was approximately 2 x 2 meters. The lights were kept on, along with cameras with microphones, 24 hours a day. He also heard loud noises playing all the time from loud-speakers, as well as the sound of a loud generator or turbine that never stopped. According to Mehdi, the noise made it difficult for prisoners to speak to each other: “They used loud music there, but it only appeared to be to punish prisoners. The guards were very strict

there.” The only other prisoner he heard during his time there was a Yemeni man who was trying to talk to other prisoners. He said he thought the man was Yemeni because of his accent, but he did not know his name. As punishment for trying to communicate with other prisoners they played extremely loud music in the Yemeni man’s cell. It was so loud that Mehdi could hear it over the loud constant sound of turbines. He said he was too afraid to ever try to communicate with other prisoners there. One time he knocked on the cell next to him and someone knocked back but he was too afraid to try and speak with him.

In his cell, there was a bottle of water, a rubber spoon like the ones used to feed children, a small bucket with a chemical for a toilet, and a thin blanket. There was no mattress. The floor was made of painted concrete. The cell had two doors: a full door that was visible from the exterior and an interior door with a gate. There were two holes: a small one allowed people outside to see and talk to him, and a second one that his guards used to pass food to him.<sup>247</sup> He said there was virtually no ventilation in the cell—no natural air, just air conditioning and one small hole. The vapors coming from the bucket, combined with the lack of ventilation, made it very hard to breathe and caused his eyes to burn. About one month into his time there, the air conditioning was turned up so that it was very cold all the time, which seriously aggravated his rheumatism.

Mehdi said he was interrogated daily, sometimes twice a day, and often while naked in front of female interrogators. He said that for the entire first month he was questioned while naked every day by a woman. He believes this was the same woman who had interrogated him in Pakistan. He said,

“She would scream and yell and was so angry. She would throw chairs, push away tables. She would say, ‘Ok, we will start all over again.’”

In total, about 10 different people, including four women, asked him questions. Unlike the guards, the interrogators wore civilian clothes, though some of them at times wore green camouflage military trousers and regular T-shirts. He described them as very fit, as if they had received professional physical training. Some questioned him over a day, others a week, and some a month.

---

<sup>247</sup> It is not clear on which of the two doors this was.



There were about 12 interpreters, possibly American, he said, but from what seemed to be different backgrounds, such as Egypt, Syria, Algeria, and Lebanon. They spoke to him in Pashto, not Arabic. They asked him questions about whom he knew and about people in photographs shown to him. One of the reasons he is sure he was in US custody is that whenever they asked him questions, they would say “Washington says this and Washington says that.” Sometimes the interpreters asked questions of their own and the interrogators would stop them and tell them only to ask the question they told them to ask.

Mehdi figured out later that he was detained in this facility for about 10 months, but while he was there it was nearly impossible to keep track of time. Sometimes he could tell the passage of time by noting when meals were delivered. Other times he would pour water on the floor before he went to sleep and would try to tell how much time had passed based upon how much water had evaporated. He was only able to tell how long he was at the facility later by calculating the time between his arrest and return to Libya.

### *Transfer and Treatment in Libya*

One night he was told that the next day, which he later learned was April 21, 2005, he would be taken to Libya. He begged his American captors not to send him back there:

I informed them that I faced a real danger if they sent me back. I was wanted in Libya.... If I reached Gaddafi, that was when the real ‘ceremony’ was going to begin. I was so clear. I said they will kill me, they will torture me. And [the proof of that was] I was [eventually] sentenced to death [there]. It was the first time I cried actually, the first tears I wept were when they told me I was being handed over to the Libyans.

He said he asked if any sort of international organization, like the International Committee of the Red Cross (ICRC), would be involved. When the Americans said no, he asked if they could be involved. He told Human Rights Watch, “They just laughed and said ‘no.’ I knew the dangers of being handed over without anyone registering me, I needed someone to know, to be involved so it was public... If this went through the ICRC, I felt like it would be safer.”

The next day the US personnel overseeing his detention transferred him to another room where they took off all his clothes. They made note on a human body chart of every mark on his body.<sup>248</sup> They also took photographs of him naked.<sup>249</sup> Before boarding a plane, they replaced one blindfold with another, which allowed him to see a huge hangar with military equipment and large aerial bombs, indicating he was at an air base.

He said he was put into a container containing a three-person American team wearing black T-shirts. These men accompanied him on the flight back to Libya. He was stripped again and more photos were taken of him naked.<sup>250</sup> Then they put him in diapers and put on earplugs, eye patches, and a hood over his head. He was given something to drink and some clothes. They handcuffed him to the seat and wrapped an adhesive or belt around him. He did not know it at the time but later learned that Khalid Sharif was with him.

Upon arrival he heard Libyan voices all around him. “Being returned to Libya was the worst fear I had,” he said. “I thought this was the end—that the real interrogations were going to start and the real suffering was going to begin.”

Mehdi said he was held in a number of different prisons in Libya. While conditions were very difficult, he was not physically abused. He was first detained for 14 months in Tajoura, where he said he was held in poor conditions, kept in solitary confinement for long periods, and subjected to numerous long and arduous interrogations. The questions very often had nothing to do with Libya but were about people from Saudi Arabia, Yemen, and other countries. His interrogators demanded information about the individuals and if they were part of al Qaeda. They often came with photos, sometimes with English writing next to them.

He experienced the worst conditions while in Libya in his next place of detention, al Nasser bureau, where he was held for four and a half months. He was in solitary confinement during this time in a very small cell that he said was about 2 x 0.5 meters in size, with no light. “They just leave you there in this place and forget about you,” he said. “You don’t

---

<sup>248</sup> Bashmilah and Maqtari also describe examinations by a doctor who noted distinctive marks and injuries on a human body chart. See Bashmilah Declaration, <http://www.chrgi.org/projects/docs/declarationofbashmilah.pdf>, (accessed May 27, 2012), para. 84; and Amnesty International, *A Case to Answer*, p. 26.

<sup>249</sup> Mehdi said in his interview that he remains concerned about the existence of these photos.

<sup>250</sup> See text box, “CIA Rendition Transportation Procedures,” (above).

know what's going to happen to you." Then he was moved to what he called the "political part" of Ain Zara prison for two months. Then on January 10, 2007, he was sent to Abu Salim prison, where he was placed in the military section, along with Belhadj, Saadi, and other senior LIFG members.

Initially the Libyan authorities accused him of being a member of the LIFG and trying to overthrow the government. He first denied the charges, but after long interrogations and time in solitary, he eventually confessed. In 2006 he was charged and prosecuted. When at trial he tried to deny the allegations and say the confession was forced, they returned him to solitary confinement.

"I don't know how to describe it," he said. "I was very hurt psychologically at that point. Because I had been in a group and then they put me back in solitary—that was the most horrifying moment for me." He confessed after one day of solitary: "I had had questions and solitary confinement. I said yes, whatever you say, I will sign it."

He was appointed a lawyer, but he never talked to her. He had one day in court and then they issued a verdict on a different day, when he was not there. He was convicted and sentenced to death. Mehdi remained in Abu Salim until February 16, 2011, when the uprisings against Gaddafi began.

### III. Transfers to Libya that Began in Asia

For three of those interviewed by Human Rights Watch, their returns to Gaddafi's Libya began in Asia. Their testimonies are described below.

#### Abdul Hakim Belhadj

Abdul Hakim Belhadj (Belhadj)<sup>251</sup> said he left Libya in 1988. He fought against the Soviet-installed government in Afghanistan in the early 1990s and later became the leader of the LIFG. After fleeing Afghanistan following the September 11 attacks, Belhadj went to various countries, ending up in China. From there, he and his wife sought asylum in the United Kingdom by traveling through Malaysia. He was denied exit from Malaysia and detained by immigration authorities there. After a subsequent attempt to reach the United Kingdom by traveling through Thailand, Belhadj and his wife were denied exit and detained by Thai authorities. They allege that while in detention there they were interrogated and ill-treated by persons they believed were Thai and US authorities.



Abdul Hakim Belhadj  
© 2012 Human Rights Watch

Belhadj and his wife were later rendered to Libya under circumstances indicating American and British involvement, which is corroborated by documents in the Tripoli Documents. Once in Libya, Belhadj was detained for years and subjected to ill-treatment—including prolonged solitary confinement—and numerous interrogations by Libyan, American, British, and other foreign personnel. After six years in Libyan detention, Belhadj was summarily tried, convicted, and sentenced to death. He was released in March 2010 as part of a “de-radicalization” initiative pushed by Saif Gaddafi and later played a prominent role in the revolution. Most notably, Belhadj served as commander of the Tripoli Military Council after revolutionary forces seized control of the city from regime forces in August 2011. He resigned his post in May 2012 to run for election to the National Congress.

<sup>251</sup> Abdul Hakim Belhadj also went by the name of Abu Abdullah al-Sadiq, sometimes spelled Sadeq.

## *Departure from Libya*

Belhadj was born in 1966 in Tripoli. He left Libya in 1988 because he said it was impossible to live under the Gaddafi government. “I was forced into exile, I didn’t have a choice! In Libya we were living under a dictatorial regime that did not permit any sort of freedom of thought or expression.... The Gaddafi regime wanted to destroy us.”<sup>252</sup> He was in his last year of engineering school when he left Libya. He first went to Saudi Arabia and then Afghanistan, where he fought against the Soviet occupation of that country.<sup>253</sup> After the Soviet-backed Afghan government of Mohammad Najibullah lost power in 1992, he and other Libyans who were part of the LIFG focused on their main aim—the overthrow of Gaddafi. Belhadj went on to become the leader of the LIFG, which from various locations around the world waged a low-level insurgency against the Libyan government for many years. Belhadj spent time in Turkey, Sudan, and other countries as well.<sup>254</sup> During this time the LIFG had bases in several different countries but also in eastern Libya, where they launched operations against the Gaddafi government. However, in the mid-1990s the LIFG in Libya was crushed, and in 1999 Belhadj, along with other LIFG members, returned to Afghanistan.<sup>255</sup>

Before September 11, 2001, Belhadj was based in Afghanistan with other LIFG members.<sup>256</sup> After the attacks, he and other LIFG members left the country, worried they would be swept up in US-led post-September 11 arrests. Belhadj and others fled to different parts of the Middle East, Africa, and Asia.<sup>257</sup> By 2004, Belhadj was living in China with his Moroccan wife, Fatima Bouchar. In early 2004, with Bouchar pregnant, the couple feared they were under surveillance and decided to seek asylum in the UK.<sup>258</sup> They first tried to travel to London from Beijing in February 2004, but the authorities in Beijing sent the couple to Kuala Lumpur, from where they had previously travelled.<sup>259</sup>

---

<sup>252</sup> Christophe Ayad, “‘We Are Simply Muslim’: Libyan Rebel Chief Denies Al-Qaeda Ties,” *Le Monde*, translated into English and published by *Time.com*, September 4, 2011, <http://www.time.com/time/world/article/0,8599,2091744,00.html>. (accessed May 2, 2012).

<sup>253</sup> *Ibid.*; Tawil, *Brothers in Arms*, p. 53.

<sup>254</sup> Ayad, “‘We Are Simply Muslim’,” *Le Monde*.

<sup>255</sup> Tawil, *Brothers in Arms*, p. 179.

<sup>256</sup> *Ibid.*

<sup>257</sup> Human Rights Watch interviews with Belhadj, Saadi, Abu Farsan, and others, Tripoli, Libya, March 2012.

<sup>258</sup> “Libyan rebel leader Abdel Hakim Belhadj sues British Government for illegal rendition to Libya,” Reprieve news release, December 19, 2011, [http://www.reprieve.org.uk/press/2011\\_12\\_19\\_belhadj\\_action/](http://www.reprieve.org.uk/press/2011_12_19_belhadj_action/) (accessed August 6, 2012).

<sup>259</sup> “Libyan rebel leader Abdel Hakim Belhadj sues British Government for illegal rendition to Libya,” Reprieve news release.

## *Malaysia and Thailand*

In Kuala Lumpur, Belhadj and his wife were detained by Malaysian authorities for 13 days and held in very bad conditions.<sup>260</sup> “My wife needed a doctor and couldn’t get health care,” Belhadj said.<sup>261</sup> He said that one of his associates had visited the British embassy in Kuala Lumpur and let officials there know that Belhadj wanted to seek asylum in the UK.<sup>262</sup> Shortly thereafter the couple was told, though it is not clear by whom, that they would be allowed to travel to the UK but only through Bangkok.<sup>263</sup> However, after the two arrived in Bangkok, they were arrested while in the airport waiting room.<sup>264</sup> They were then taken to a special room in the airport in Bangkok in which, Belhadj alleges, he and his wife were severely mistreated and abused by the CIA for several days.<sup>265</sup>

While in CIA custody in Bangkok, Belhadj said he was “stripped and beaten.”<sup>266</sup> He was forced to be naked, wear a blindfold, was hung against a wall by one arm and then by one leg, and was put into a tub with ice.<sup>267</sup> He was also forced to wear earmuffs that were only removed when his captors blasted his cell with loud music or when he was being interrogated.<sup>268</sup> Belhadj said they gave them no food and they refused to get him a doctor when he told them he needed one.<sup>269</sup> He was asked about his alleged ties to al Qaeda, which he denied.<sup>270</sup>

Belhadj’s wife said that she was dragged away from her husband at the Bangkok airport and feared he was going to be killed. In an interview with *The Guardian*, she said, “I thought:

---

<sup>260</sup> Ibid.; Also, Human Rights Watch interview with Belhadj, Abu Salim Prison, Tripoli, April 27, 2009.

<sup>261</sup> Human Rights Watch interview with Belhadj, Abu Salim Prison, Tripoli, April 27, 2009.

<sup>262</sup> Martin Chulov, “MI6 knew I was tortured, says Libyan rebel leader,” *The Guardian*, September 5, 2011, <http://www.guardian.co.uk/world/2011/sep/05/abdul-hakim-belhaj-libya-mi6-torture?INTCMP=ILCNETTXT3487> (accessed June 15, 2012).

<sup>263</sup> “Libyan rebel leader Abdel Hakim Belhadj sues British Government for illegal rendition to Libya,” Reprieve news release.

<sup>264</sup> Human Rights Watch interview with Belhadj, Abu Salim Prison, Tripoli, April 27, 2009.

<sup>265</sup> Ibid. At that time, Belhadj told a Human Rights Watch researcher that he was detained in Bangkok by the CIA from around March 3, 2004 until he was sent to Libya on March 9, 2004.

<sup>266</sup> Ibid.

<sup>267</sup> Ibid.

<sup>268</sup> Ian Cobain, “Special report: Rendition ordeal that raises new questions about secret trials,” *The Guardian*, April 8, 2012, <http://www.guardian.co.uk/world/2012/apr/08/special-report-britain-rendition-libya> (accessed May 2, 2012); See also Deborah Haynes, “Faces of new Libya tell of ‘torture’ inflicted on them with British aid,” *The Times*, May 23, 2012.

<sup>269</sup> Human Rights Watch interview with Belhadj, Abu Salim Prison, Tripoli, April 27, 2009.

<sup>270</sup> Ibid.

‘This is it.’ I thought I would never see my husband again.... They took me into a cell, and they chained my left wrist to the wall and both my ankles to the floor. I could sit down but I couldn’t move.” She said her captors included two tall, thin men and an equally tall woman who were mostly silent and dressed in all black.<sup>271</sup> At the time, Bouchar was four and a half months pregnant. “They knew I was pregnant,” she said. “It was obvious.”<sup>272</sup> She said her captors gave her water while she was chained up, but no food for five days.<sup>273</sup>

The couple said they were separately put on a plane to Libya, but were not aware that the other was on the flight.<sup>274</sup> Belhadj said he was handcuffed and blindfolded and that his hands were tied to his legs.<sup>275</sup> He was crouched over, unable to stand or lie down, for the entire 17-hour journey. He was forced to drink water and prevented from using the bathroom.<sup>276</sup> He said he was beaten just before the plane landed.<sup>277</sup> Sometimes his captors put a cushion under his elbows, providing brief respite, but then took it away again.<sup>278</sup>

Bouchar later told *The Guardian* that her captors forced her to lie on a stretcher and bound her to the stretcher from head to toe with tape. They taped her stomach, arms, and then her chest so tightly that she was unable to move. They then wound the tape around her head, covering her eyes, before putting a hood and earmuffs on her. She was unable to move, to hear or to see. “My left eye was closed when the tape was applied ... but my right eye was open, and it stayed open throughout the journey. It was agony,” she said. She did not know where she was going or that her husband was on the plane. Only upon arrival in Libya did she hear a man grunting with pain, and realized her husband was with her.<sup>279</sup> The Tripoli Documents corroborate the couple’s account. The UK government appears to have alerted Libyan authorities that Belhadj and his wife were in Malaysian custody.<sup>280</sup> A

---

<sup>271</sup> Cobain, “Special report: Rendition ordeal that raises new questions about secret trials,” *The Guardian*.

<sup>272</sup> *Ibid.*

<sup>273</sup> *Ibid.*

<sup>274</sup> *Ibid.*

<sup>275</sup> Human Rights Watch interview with Belhadj, Abu Salim Prison, Tripoli, April 27, 2009.

<sup>276</sup> *Ibid.*

<sup>277</sup> *Ibid.*

<sup>278</sup> Cobain, “Special report: Rendition ordeal that raises new questions about secret trials,” *The Guardian*.

<sup>279</sup> *Ibid.*

<sup>280</sup> Tripoli Document 2264 appears to be a document sent by the UK secret service to the Libyan intelligence service. Human Rights Watch photographed a copy of this document, but it is too blurry to read. A legible copy was also obtained by *The Guardian* and is available at <http://www.guardian.co.uk/world/interactive/2012/apr/08/libya-mi6> (accessed June 14, 2012).

document in the folder marked “UK” mentions that Abdullah Sadeq (the name Belhadj was using at the time), travelling under a French or an Iraqi identity, “is being held in the Sepang detention center in Malaysia” with his “pregnant wife.”<sup>281</sup> The document is undated, but notes that the couple was traveling around February 21.<sup>282</sup>

Two faxes found in the folder marked “USA,” both dated March 4, 2004 and marked “Secret Release Libya Only,” appear to have been sent by the CIA to the Libyan Security Service. One has a subject line that reads, “Clarification Regarding the Rendition of Abu Abdullah al-Sadiq.”<sup>283</sup> The other had a subject line that reads, “Urgent Request Regarding the Extradition of Abdullah al-Sadiq from Malaysia.”<sup>284</sup> It is not clear which fax was sent first, but the fax seeking clarification begins by thanking the Libyan security service for the “hospitality” that it showed to CIA officers during their recent visit to Libya; remarks that the discussions had during that visit were “very productive;” and pronounces that they are “committed to developing this relationship” for the “mutual benefit” of both services. It then goes on to read:

Our service is committed to rendering the terrorist Abu Abdullah al-Sadiq to your custody. To this end, we have been in touch with the Malaysian authorities to help facilitate the transfer of custody in a timely [sic] manner. We do not yet have all the details from our station in Kuala Lumpur regarding how and when this transfer will take place, but we are very hopeful for a [sic] expeditious resolution to this matter. We will provide you with the details as soon as they are available to us.<sup>285</sup>

The other fax dated the same day, with “urgent request” in the subject line, says the United States is working “energetically” with the Malaysian government to “effect the extradition of Abdullah al-Sadiq” from Malaysia. It says that the Malaysians have “promised to cooperate and to arrange for Sadiq’s transfer to our [the CIA’s] custody” and that they will be “very happy to service your debriefing requirements” and “will share the

---

<sup>281</sup> Ibid.

<sup>282</sup> Ibid.

<sup>283</sup> Tripoli Document 2173.

<sup>284</sup> Tripoli Documents 2173 and 2174.

<sup>285</sup> Tripoli Document 2173.



information with you [Libyan security service].” The fax also says that the CIA was “at a delicate point in [its] discussions with the Malaysians” and therefore asks that the Libyans temporarily “cease any further engagement” with the Malaysian government until the CIA has “custody of Sadiq” or has judged that the Malaysians are “unwilling to cooperate with the U.S. government.”<sup>286</sup>

Two days later, on March 6, the CIA sent the Libyans another fax saying that Belhadj and his “pregnant (4 months) wife” would be leaving Kuala Lumpur on the evening of March 7, on a commercial flight to London via Bangkok, corroborating Bouchar’s belief that her captors knew she was pregnant.<sup>287</sup> The CIA said it planned to take custody of the couple in Bangkok, and that it was “vital” that a Libyan security officer be present to accompany the couple on the flight from Bangkok to Libya.<sup>288</sup>

Also on March 6, the CIA sent another fax, with the subject line “Schedule for the Rendition of Abdullah al-Sadiq,” to Libyan intelligence.<sup>289</sup> It details the flight plan for the aircraft that was supposed to pick up Belhadj and his wife and take them to Libya. The fax informs the Libyan intelligence service that the flight will leave Washington, DC Dulles International Airport on March 6/7, make a stop in Tripoli and refuel on March 7, then fly to the Seychelles, where it will remain overnight. Then on March 8, it will leave the Seychelles for Bangkok, where it will refuel, presumably pick up Belhadj and his wife, and fly to Tripoli, with a stopover for half a day in Diego Garcia (a US naval air base in the British Indian Ocean Territory).<sup>290</sup> The fax asks the Libyans to make sure their officers “have the proper documentation for [the Seychelles], otherwise they will not be allowed to leave the aircraft.”<sup>291</sup>

---

<sup>286</sup> Tripoli Document 2174.

<sup>287</sup> Tripoli document 2172, a fax from the CIA to the Libyan intelligence service.

<sup>288</sup> Ibid.

<sup>289</sup> Tripoli Document 2171.

<sup>290</sup> Ibid. Representatives of the British government denied that Diego Garcia played any role in the global rendition program, including in meetings with Human Rights Watch, but later, after confronted with evidence, apologized and admitted that in fact two rendition flights had refueled there in 2002. Colin Brown, “Official apology after CIA ‘torture’ jets used UK base,” *The Independent*, February 22, 2008, <http://www.independent.co.uk/news/uk/politics/official-apology-after-cia-torture-jets-used-uk-base-785596.html> (accessed July 25, 2012). There was no mention at the time of the 2004 Belhadj or Saadi renditions, and the government Foreign Office has declined to comment further. Cobain, “Special report: Rendition ordeal that raises new questions about secret trials,” *The Guardian*; See also “Abdel Belhadj: The rendition flight,” *The Telegraph*, April 18, 2012, <http://www.telegraph.co.uk/news/politics/9210950/Abdel-Belhadj-the-rendition-flight.html> (accessed July 23, 2012).

<sup>291</sup> Tripoli Document 2171.

The flight plan laid out in the document corresponds to some Eurocontrol flight data on file with Human Rights Watch. According to that data, a flight plan for a Boeing 737 with tail number N313P (the same tail number as a plane mentioned in Tripoli Document 2233, which apparently transported the MI6's Mark Allen and the CIA's Steve Kappes to Libya—see below), operated by Aero Contractors—a North Carolina company widely reported to have been used by the CIA—filed a flight plan to go from Dulles airport in Washington at 2:51 a.m. on March 7, 2004 and land in Tripoli at 12:01 p.m. local time. The plane then appears to have flown beyond Eurocontrol's area of responsibility, because it disappears temporarily from Eurocontrol's flight records. The plane's trajectory is not recorded again in the Eurocontrol records until March 9, 2012, when a flight plan was filed for a departure from Misrata, Libya on March 9 at 4:47 p.m. local time for Palma Majorca, an island off the coast of Spain.

Another of the Tripoli Documents provides evidence of the role of the United States and the United Kingdom in Belhadj's transfer back to Libya. At the end of a two-page letter from "Mark in London" (presumably Mark Allen, former head of counterterrorism at MI6 named in other Tripoli Documents)<sup>292</sup> dated March 18, 2004, to "Musa," he writes to "congratulate" Musa Kusa on the "safe arrival of Abu 'Abd Allah Sadiq," the name Belhadj used at the time.<sup>293</sup> The letter continues, "[t]his was the least we could do for you and for Libya to demonstrate the remarkable relationship we have built over the years." Then, corroborating US involvement, he writes, "Amusingly, we got a request from the Americans to channel

---

<sup>292</sup> The "Mark" who signed the letter is believed to be Mark Allen, former head of counterterrorism at MI6, because he is named in a number of other Tripoli Documents where other "CIA" and "MI6" issues are discussed. For example, Document 2226, dated June 19, 2003, signed by "Mark" and "Steve" to Musa Kusa, discusses an upcoming "joint CIA and SIS" "technical visit" by a "team of experts" to Libya to examine Libya's "WMD" (Weapons of Mass Destruction) program. Another letter depicted in Document 2233 is about either the technical visit referenced in Document 2226 or a different one. It says that "Mark Allen" and "Steve Kappes" will be arriving in Libya for a "joint US/UK technical visit" on a Boeing 737 Business Jet with tail number N313P. A Boeing 737 with registration number N313P has been linked to a large number of CIA rendition flights. See Human Rights Watch, *Double Jeopardy: CIA Renditions to Jordan*, April 2008, [http://www.hrw.org/sites/default/files/reports/jordano408\\_1.pdf](http://www.hrw.org/sites/default/files/reports/jordano408_1.pdf), p. 24-25; See also "Human Cargo: Binyam Mohamed and the Rendition Frequent Flier Programme," Reprieve, June 10, 2008, <http://www.reprieve.org.uk/publications/humancargo/> (accessed July 25, 2012), p. 16, n. 35. A "Mark Allen" was MI6's director of counterterrorism at the time these letters were written and Steve Kappes is a former deputy director of the CIA. See Richard Norton-Taylor, "Sir Mark Allen: the secret link between MI6, the CIA and Gaddafi," *The Guardian*, September 4, 2011, <http://www.guardian.co.uk/world/2011/sep/04/mark-allen-mi6-libya-profile> (accessed July 25, 2012); Jeff Stein, "Inside Man," *Washingtonian*, March 25, 2010, <http://www.washingtonian.com/articles/people/inside-> (accessed July 25, 2012); and George Tenet, *At the Center of the Storm: My Years at the CIA* (New York: HarperCollins Publishers, 2007), p. ix, where Steve Kappes is identified as senior officer in the clandestine service, and p. 289-97, where Kappes' trips to Libya with a senior British officer to evaluate Libya's weapons WMD program is discussed in detail.

<sup>293</sup> Tripoli Documents 2266 and 2267, a fax from MI6 to Libyan intelligence service.

requests for information from Abu ‘Abd Allah through the Americans. I have no intention of doing any such thing. The intelligence about Abu ‘Abd Allah was British. I know I did not pay for the air cargo. But I feel I have the right to deal with you direct on this and am very grateful to you for the help you are giving us.”<sup>294</sup> The exchange took place just a week before British Prime Minister Tony Blair made an official visit to Tripoli and praised Gaddafi for his willingness to help fight the so-called war on terror.<sup>295</sup> Earlier in the letter, details about the upcoming Blair visit are discussed.<sup>296</sup> “No. 10,” paragraph 5 of the blurry but legible document reads—referring to No. 10 Downing Street, the residence of the British prime minister—is “keen” that he meet the “Leader” in his tent. “[J]ournalists would love it,” the letter continues. “If this is possible, No. 10 would be grateful,” it reads.<sup>297</sup>

The Tripoli Documents formed the basis of a lawsuit that Belhadj and his wife initially brought against the UK government and its security forces.<sup>298</sup> Later Belhadj and his wife also sued former Foreign Secretary Jack Straw for personally signing off on their abduction and transfer.<sup>299</sup> When the suit was initiated, Belhadj said his main aim was an apology and acknowledgement of wrongdoing.<sup>300</sup> Only when requests for this were ignored did he decide to sue.<sup>301</sup> Belhadj told the nongovernmental organization Reprieve, “What we have asked for like many victims of rendition in the past is an apology. All we seek is justice.... We hope the new Libya, freed from its dictator, will have positive relationships with the

---

<sup>294</sup> Ibid.

<sup>295</sup> “Blair hails new Libyan relations,” March 25, 2004, BBC News, [http://news.bbc.co.uk/2/hi/uk\\_news/politics/3566545.stm](http://news.bbc.co.uk/2/hi/uk_news/politics/3566545.stm) (accessed August 27, 2012).

<sup>296</sup> See Tripoli Documents 2266 and 2267. Parts of the document are blurry, but it is dated March 18, 2004. Paragraphs 4 and 5 discuss the “present thinking” of “No. 10” and whether the “Leader” and the prime minister will have a press conference. It also discusses how many journalists will be going (about 60).

<sup>297</sup> See Tripoli Documents 2266 and 2267; and also Tripoli Document 2226, dated June 19, 2003.

<sup>298</sup> “Belhadj lawyers announce fresh legal action in rendition case,” Leigh Day & Co. news release, April 9, 2012, <http://www.leighday.co.uk/News/2012/April-2012/Belhadj-Lawyers-Announce-Fresh-Legal-Action-in-Ren> (accessed June 15, 2012).

<sup>299</sup> “Legal Papers Served on Former Foreign Secretary,” Leigh Day & Co. news release, April 18, 2012, <http://www.leighday.co.uk/News/2012/April-2012/Legal-Papers-Served-on-Former-Foreign-Secretary> (accessed June 15, 2012); See also “Libyan Rebel Leader Sues British Government for Illegal Rendition to Libya,” Leigh Day & Co. news release, December 19, 2011, <http://www.leighday.co.uk/News/2011/December-2011/Libyan-Rebel-Leader-Sues-British-Government-for-Il> (accessed June 15, 2012).

<sup>300</sup> “Legal Papers Served on Former Foreign Secretary,” Leigh Day & Co. news release, April 18, 2012, <http://www.leighday.co.uk/News/2012/April-2012/Legal-Papers-Served-on-Former-Foreign-Secretary> (accessed June 15, 2012).

<sup>301</sup> “Libyan Rebel Leader Sues British Government for Illegal Rendition to Libya,” Leigh Day & Co. news release, December 19, 2011.

West. But this relationship must be built on respect and justice. Only by admitting and apologizing for past mistakes ... can we move forward together as friends.”<sup>302</sup>

The Tripoli Documents also led to a criminal investigation by UK Police into MI6’s involvement in the rendition of Belhadj and Saadi (see below), another Libyan who was rendered to Libya with MI6 and CIA assistance.<sup>303</sup>

### *Treatment in Libya*

Upon arrival in Libya, Belhadj and his wife were driven separately to Tajoura prison in Tripoli.<sup>304</sup> Belhadj said he was then brought directly to Musa Kusa, who was standing right in front of him when his blindfold was removed. “I’ve been waiting for you,” Belhadj said Kusa told him.<sup>305</sup>

Bouchar was put in a cell where she would spend the next four months.<sup>306</sup> She told *The Guardian* that she was interrogated for about five hours a day. “At one point a cot was brought in the cell along with some baby clothes, nappies, a bed cover and a baby bath,” she said. “I really thought I was going to have to have my baby there, and that we would both be held there.”<sup>307</sup> Bouchar was released three weeks before giving birth to a son.<sup>308</sup> Belhadj was brought to her cell for a few moments before she was set free, though not permitted to leave the country.<sup>309</sup>

Belhadj was held for six more years, five of them in solitary confinement.<sup>310</sup> He said he went for a year and a half without any sunlight. His treatment depended upon how responsive he was during interrogations. He was denied family visits for three years and then

---

<sup>302</sup> “Watch Libyan rendition victim Abdel Hakim Belhadj talk to the European Parliament,” Reprieve.com, April 12, 2012, at 0:16 and 2:30, [http://www.reprieve.org.uk/tvandrado/Belhadj\\_European\\_Parliament/](http://www.reprieve.org.uk/tvandrado/Belhadj_European_Parliament/) (accessed on June 15, 2012).

<sup>303</sup> “Joint statement by the Director of Public Prosecutions and the Metropolitan Police Service,” Crown Prosecution news release.

<sup>304</sup> Human Rights Watch interview with Belhadj, Abu Salim Prison, Tripoli, April 27, 2009.

<sup>305</sup> “Watch Libyan rendition victim Abdel Hakim Belhadj talk to the European Parliament,” Reprieve.com.

<sup>306</sup> Cobain, “Special report: Rendition ordeal that raises new questions about secret trials,” *The Guardian*.

<sup>307</sup> Ibid.

<sup>308</sup> “Libyan Rebel Leader Sues British Government for Illegal Rendition to Libya,” Leigh Day & Co. news release, December 19, 2011.

<sup>309</sup> Cobain, “Special report: Rendition ordeal that raises new questions about secret trials,” *The Guardian*.

<sup>310</sup> Human Rights Watch Interview with Belhadj, Tripoli, Libya, March 28, 2012.

subsequently was able to receive visits every three months. He said he was deprived of sleep and often interrogated at night and forced to stand for long periods of time.<sup>311</sup>

While he was in Libyan custody, Belhadj said he was interrogated four times by people he believes were American agents.<sup>312</sup> He was also interrogated by alleged British agents during two sessions that lasted about two hours each.<sup>313</sup> He said they were very knowledgeable about the LIFG and asked questions about members living in the United Kingdom. His Libyan captors told him that his treatment would improve if he told the British that the LIFG activists were linked with al Qaeda.<sup>314</sup> “I told the British, as I told everyone else, that LIFG had no link with al-Qa’ida. I knew making a link would stop what was happening to me, but I was not going to do it.”<sup>315</sup> Intelligence officers from other European countries, including France, Italy, Germany, and Spain, also interrogated him while he was detained in Libya.<sup>316</sup>

The authorities tried Belhadj in 2008 for crimes against the state. Although he had a state-appointed lawyer, he was never given a chance to meet with him. There were no witnesses at the trial, and the only evidence taken into consideration was a report from Libyan security services.<sup>317</sup> He was sentenced to death.<sup>318</sup> “I fully expected I would be killed,” he said.<sup>319</sup> Instead, over time and in conjunction with efforts started by Gaddafi’s son, Saif Gaddafi, he began to participate in an effort to negotiate a prisoner release. Several hundred prisoners, including Belhadj, Saadi, and Sharif were released in early 2010.<sup>320</sup> To obtain his release, he had to publicly renounce his efforts to overthrow the government by force.<sup>321</sup> However, he told Human Rights Watch that he never gave up his desire for regime

---

<sup>311</sup> Ibid.

<sup>312</sup> Human Rights Watch interview with Belhadj, Abu Salim Prison, Tripoli, April 27, 2009.

<sup>313</sup> Kim Sengupta, “Libyan rebel leader says MI6 knew he was tortured,” *The Independent*, September 6, 2011, <http://www.independent.co.uk/news/world/africa/libyan-rebel-leader-says-mi6-knew-he-was-tortured-2349778.html> (accessed May 2, 2012).

<sup>314</sup> Ibid.

<sup>315</sup> Ibid.

<sup>316</sup> Ibid.; See also, Chulov, “MI6 knew I was tortured, says Libyan rebel leader,” *The Guardian*.

<sup>317</sup> Human Rights Watch interview with Belhadj, Abu Salim Prison, Tripoli, April 27, 2009.

<sup>318</sup> Human Rights Watch Interview with Belhadj, Tripoli, Libya, March 28, 2012.

<sup>319</sup> “Watch Libyan rendition victim Abdel Hakim Belhadj talk to the European Parliament,” Reprieve.com.

<sup>320</sup> “Libya: 202 Prisoners Released But Hundreds Still Held Arbitrarily,” Human Rights Watch news release, March 25, 2010, <http://www.hrw.org/news/2010/03/25/libya-202-prisoners-released-hundreds-still-held-arbitrarily>.

<sup>321</sup> Tawil, “The Libyan Islamic Fighting Group’s revisions: one year later,” *Magharebia*, [http://magharebia.com/cocoon/awi/xhtml1/en\\_GB/features/awi/features/2010/07/23/feature-02](http://magharebia.com/cocoon/awi/xhtml1/en_GB/features/awi/features/2010/07/23/feature-02). LIFG spiritual leader Saadi and Deputy LIFG leader Sharif were released along with Belhadj. The three of them co-authored a document entitled

change.<sup>322</sup> In February 2011 the uprisings against Gaddafi began and Belhadj played a significant role, particularly in the capture of Tripoli.<sup>323</sup> He then became part of the transitional government's Tripoli Military Council, but stepped down to take part in elections in Libya on July 7, 2012. Belhadj ran as a candidate under the Islamist political party Hizb al-Watan which, although initially popular, did not do as well as expected.<sup>324</sup> They lost to the liberal National Forces Coalition party headed by Mahmoud Jibril.<sup>325</sup>

---

"Corrective Studies in Understanding Jihad Accountability and the Judgment of the People," in which they renounced the use of force to achieve political aims. Saadi and Sharif were both interviewed for this report (see below); See also a text of selected translations of "Corrective Studies in Understanding Jihad, Accountability and the Judgment of People" in Mohammed Ali Musawi, "Selected Translation of the LIFG Recantation Document," Quilliam 2009, <http://www.solami.com/jihadstudy.pdf> (accessed June 19, 2012); See also, "Watch Libyan rendition victim Abdel Hakim Belhadj talk to the European Parliament," Reprieve.com.

<sup>322</sup> Human Rights Watch Interview with Belhadj, Tripoli, Libya, March 28, 2012.

<sup>323</sup> Rod Nordland, "In Libya, Former Enemy Is Recast in Role of Ally," *New York Times*, September 1, 2011, <http://www.nytimes.com/2011/09/02/world/africa/02islamist.html?pagewanted=all> (accessed August 27, 2012).

<sup>324</sup> Aymehh Jawad al-Tamimi, "Rethinking Libya," *The American Spectator*.

<sup>325</sup> *Ibid.*



Sami Mostefa al-Saadi  
© 2012 Human Rights Watch

## Sami Mostefa al-Saadi

Sami Mostefa al-Saadi (Saadi)<sup>326</sup> left Libya in 1988. He spent time in Afghanistan, fighting against the Soviet-installed government. He was, as was Belhadj, a founding member of the LIFG. Later, rather than go back to Libya, he sought asylum in the United Kingdom, where he was granted “indefinite leave to remain.” After a series of incidents made him feel unsafe there, he returned to Afghanistan and Pakistan. He eventually became the LIFG’s law and religious leader. After the September 11

attacks, he fled with his family to Iran and then went to Malaysia where he tried to seek asylum, failed, and traveled on to China, where he decided to try to return to

the United Kingdom via Hong Kong. In Hong Kong, he and his family were detained and ultimately rendered to Libya, with apparent direct US and UK involvement, as corroborated by the Tripoli Documents.

In Libya, Saadi suffered abusive treatment in custody for five years, during which time he was interrogated by, in addition to Libyan authorities, persons he believes were US and UK personnel. He was charged, given a summary trial, and sentenced to death.

Human Rights Watch interviewed Sami Mostefa al-Saadi in Tripoli on March 14, 2012 as well as Saadi and his daughter Kadija on March 25, 2012. The following account and quotes are drawn from the former interview unless otherwise noted.<sup>327</sup>

### *Departure from Libya*

Saadi was born in Tripoli on March 21, 1966. His family had a lot of property and businesses, all of which he said were “misappropriated by the state” by the Gaddafi government. He left Libya in 1988, in his early 20s, because he said the government was interfering with his ability to practice his religion and because he generally opposed its oppressive prac-

---

<sup>326</sup> Sami Mostefa al-Saadi’s name is sometimes spelled “es-Saidi” or “Essaadi.” He also went by the names of “Abu Munder,” sometimes spelled “Abu Munthir” or “Abu Munder,” and “Hisham Mohamaed.”

<sup>327</sup> Human Rights Watch interview with Saadi, Tripoli, Libya, March 14, 2012.

tices. While he was studying engineering at the University of Tripoli, he became actively involved in a small secret group in Libya (a precursor to the LIFG) that, at the time, was engaged in planning to resist the government by force. He later became a founding member of the LIFG and its law and religious leader.<sup>328</sup> He was detained once in 1984 for a month for distributing anti-Gaddafi leaflets. When Saadi left Libya, he went to Afghanistan via Saudi Arabia and Pakistan to assist in efforts to oppose the Soviet-installed government. “I believed in the fact that Afghan people were oppressed,” he said. He left two brothers behind, both of whom were imprisoned for many years for their anti-Gaddafi activities and both of whom he said died in the Abu Salim prison massacre of 1996.

After the Afghan government fell in 1992, infighting among groups in Afghanistan made it hard to stay in the area. He also said it was very difficult for Arabs to remain. So in 1993 he sought asylum in the United Kingdom. In 1994, Saadi was granted “indefinite leave to remain.”<sup>329</sup>

At some point, either prior to or during his time in the UK, he went to Algeria and got married. From 1994 to 1997 Saadi was in the UK, where he and other LIFG members continued to organize and plan operations against Gaddafi. By 1997, however, he began to feel unsafe there as well. Twice, an individual approached him and tried to speak to him in Urdu and Arabic, asking him questions that showed knowledge about his family and attempting to get information from him. Then a Libyan associate of his who was opposed to Gaddafi, Ali Abuseid, was killed in a stabbing in his grocery store in London in 1996.<sup>330</sup> So Saadi left with his family and other LIFG members and they began to organize from Pakistan and Afghanistan. Saadi said he felt “there was no other place for us to go.”

During his years in Afghanistan, Saadi lived and worked in Kabul, where the LIFG was active. He said he met Osama bin Laden on two occasions in Kandahar, in 2000 and in the late summer of 2001. Saadi told Human Rights Watch that bin Laden had already been

---

<sup>328</sup> Tawil, *Brothers in Arms*, p. 53.

<sup>329</sup> “Claim on Behalf of Sami al-Saadi Against the Hong Kong Special Administrative Region (HKSARG),” June 12, 2012, <http://www.therenditionproject.org.uk/pdf/PDF%202008%20%5BClaim%20for%20damages,%20al%20Saadi%20v%20Hong%20Kong,%2012%20Jun%202012%5D.pdf> (accessed June 17, 2012).

<sup>330</sup> For an account of this killing, see Hilsum, *Sandstorm*, p. 96-97.



making harsh statements against the United States and it was clear to him that bin Laden was planning violence against the US. Saadi said he had an argument with Osama bin Laden about this where he told him that for many reasons, the actions against the US that he was planning were not legally authorized within Sharia. “We told OBL [bin Laden] that the consequences of operations against civilians would be negative, but he was not convinced,” Saadi said.

Immediately after the September 11 attacks, Saadi and several other LIFG members and their families left the area, moving from place to place to avoid arrest. They first went to Pakistan, but that did not feel safe there either. They then moved on to Iran. They sent their families there first. “I asked my wife if she wanted to go to Algeria and be with her family there, but she preferred to be with me,” Saadi said. But at the time Saadi himself could not get proper papers for Iran, so he crossed over borders illegally, only meeting his family there later. They stayed in Iran for about a year. “The LIFG were all there together in a sort of community,” he said. But in January 2003, he said they were forced to leave Iran. By this time, Saadi had four children.

They went to Malaysia, where he hoped to get asylum. He visited a UN office and was given an appointment for a month later. Before then, he was arrested by the Malaysian authorities, who detained him and his family for about 10 days. Saadi asked to be released to go to his UN appointment. The Malaysian authorities said they would, but if he went back to the UN, he would find US officials waiting for him. So he asked to be sent to China, where he had already obtained a visa. “The Chinese visa was so easy for us,” he said. “The Chinese were receiving people from everywhere at the time.” The Malaysians then sent him to China.

From China he attempted to get back to the United Kingdom. Saadi’s friends and family in the UK told him that if he went to the UK embassy in Hong Kong, someone there would be able to help him.<sup>331</sup> When he arrived in Hong Kong, a man he assumed was a UK diplomat was waiting for him when he got off the plane. Instead, he was arrested for purported passport or immigration violations and detained, most of the time with his family. The

---

<sup>331</sup> Saadi talked more expansively about this to *The Guardian*. While in China in March 2004, he said he was approached by British intelligence officers via an intermediary in the UK and was told that he would be permitted to return to London. First, however, he would have to be interviewed at the British consulate in Hong Kong and would be met by British diplomats on his arrival. Ian Cobain, Mustafa Khalili and Mona Mahmood, “How MI6 deal sent family to Gaddafi’s jail,” September 9, 2009, <http://www.guardian.co.uk/world/2011/sep/09/how-mi6-family-gaddafi-jail> (accessed June 17, 2012).

room was monitored with cameras. During this period he said he overheard two police women arguing: “They were talking in their own language and I didn’t understand everything, but I did hear ‘CIA’ about four or five times, so I expected that something not good was about to happen.” After 13 days of detention, the Hong Kong authorities told him he would be sent back to China.

On or about March 28, 2004, Saadi said he was handcuffed, his legs zip-tied, and he was taken along with his wife and four children onto an empty plane with an Egyptian crew. He and his children were taken to the back of the plane, while his wife, who was screaming and in what he described as a “terrible psychological condition,” was kept elsewhere. It was not until five Libyan security personnel—four men and a woman—appeared on the plane during a stopover in Bangkok that Saadi realized he was being rendered to Libya. Once he realized it, he lost consciousness. Saadi is diabetic and his blood sugar had risen. “That’s when I first realized I was being sent back to Libya. It was a mixture of horrible emotions: anger, fear, sadness.”

“I felt like we were being kidnapped. I was very scared. I thought they would execute us all,” Kadija al-Saadi, Saadi’s oldest child who was 13 years old at the time, said.<sup>332</sup> Around this time, she came to the area of the plane where her father was. When she saw many soldiers around him and the needle in his arm while he was still handcuffed to the chair, “I fainted too,” she said. Later during the flight, about half an hour before they landed, Libyan security agents came and told her to come and say goodbye to her father. “I expected that that was when they would come and execute him,” she said.<sup>333</sup>

The Tripoli Documents corroborate Saadi’s story. Saadi’s return appears to have been initiated by the MI6, but once the CIA discovered it was underway, they stepped in to do everything they could to assist. A March 23, 2004 fax from the CIA to Libyan intelligence, found in the folder marked “USA,” states that the CIA has “become aware” that Saadi and his family were being held in detention in Hong Kong and that the Libyans have been working with the British to “effect [his] removal to Tripoli” on a Libyan plane that was in the Maldives.<sup>334</sup> In the fax, the CIA said that it was aware that the Hong Kong special wing had

---

<sup>332</sup> Human Rights Watch interview with Kadija al-Saadi, Tripoli, Libya, March 25, 2012.

<sup>333</sup> Ibid.

<sup>334</sup> Tripoli Documents 2162-2163.

denied permission for the Libyan airplane to land. It went on to explain, “However, we believe that the reason for the refusal was based on international concerns over having a Libyan-registered aircraft land in Hong Kong. Accordingly, if your government were to charter a foreign aircraft from a third country, the Hong Kong government may be able to coordinate with you to render Abu Munthir [Saadi] and his family into your custody.”<sup>335</sup> The CIA even offered to pay for the non-Libyan-registered charter aircraft. “If payment of a charter aircraft is an issue, our service would be willing to assist financially to help underwrite those costs.”<sup>336</sup>

The CIA requested perfunctory diplomatic assurances that Saadi and his family would not be harmed if they provided assistance: “Please be advised if we pursue that option [providing assistance], we must have assurances from your government that Abu Munthir [Saadi] and his family will be treated humanely and that his human rights will be respected.”<sup>337</sup>

In the same fax, the CIA also provided suggestions as to how the Libyans might expedite the process and convince the Hong Kong authorities to cooperate.<sup>338</sup> “[W]e believe that you will need to provide significant detail on Abu Munthir (e.g. his terrorist/criminal acts, why he is wanted, perhaps proof of citizenship).... Specifically, the Hong Kong government must have a stipulation ... that he will not be subject to the death penalty.”<sup>339</sup>

The next day, on March 24, 2004, the Libyan authorities sent a 32-page fax to Hong Kong authorities containing, among other things, a birth certificate, information on why Saadi was wanted, and details on the “crimes and the terrorist activities that [Saadi] committed.” They also promised that the “maximum penalty” for what he had done was “life imprisonment.”<sup>340</sup> (Though later, after being in Libyan custody for five years without charge, Saadi

---

<sup>335</sup> Tripoli Documents 2162-2163.

<sup>336</sup> Ibid.

<sup>337</sup> Ibid.

<sup>338</sup> Ibid.

<sup>339</sup> Ibid.

<sup>340</sup> Tripoli Documents 2280-2283, 2300-2311 (only relevant pages, with the exception of the birth certificate which is not included, of the 32 page fax are contained herein). The document seems to have been sent to the Hong Kong Authorities by the Libyan government, given that the letter is signed by “NCB Tripoli” (see Document2281). It was contained in the folder marked UK. Perhaps the Libyans faxed a copy of what had been sent to the Hong Kong authorities to the UK government in order to show they had complied with Hong Kong’s demands.

was sentenced to death). The United States also provided the name and telephone numbers for Hong Kong's principal secretary for security.<sup>341</sup>

After the Hong Kong authorities received this information, it appears they agreed to allow the non-Libyan registered charter aircraft to land. Also in the Tripoli Documents, in the folder marked "USA," a fax sent just two days before Saadi arrived in Libya contains a cover page marked "Hong Kong Landing Requirements" and two pages stamped "confidential." It states that in order for the "Non-Scheduled Flight to land in Hong Kong," the Libyan government has to comply with "certain regulations" so that a "Permission to Land" can be issued.<sup>342</sup> It also confirms, "[i]t is agreed that the subject person will be moved together with his whole family (a total of six persons) on board of the same flight" and recommends a "local Aircraft Handling Agent" for the transaction who needs to be paid in "cash (in US dollars)."<sup>343</sup> Saadi was transferred around March 28, 2004, just a few days after Tony Blair's historic first visit to Libya on March 25.<sup>344</sup>

### *Treatment in Libya*

Three days later, Saadi and his family were put aboard a private, Egyptian-registered jet and flown to Tripoli. When they landed, Saadi said he and his wife were both hooded in front of their children. Local authorities took them to the External Security Office of Amn Kharihi prison in Tajoura, where they were separated. Saadi's wife and children were held at the facility for two months before being released. Saadi was detained for six years and only saw his family sporadically.<sup>345</sup>

Saadi said that the day after he arrived on March 28, 2004, Musa Kusa, the head of the Libyan intelligence service, came to his cell and said, "Before 9/11, you went to countries where we couldn't reach you. But now, after 9/11, I can just pick up the phone and call MI6 or the CIA right away and they will provide us with the most recent or up to date information on you."<sup>346</sup>

---

<sup>341</sup> Tripoli Documents 2162-2163.

<sup>342</sup> Tripoli Documents 2156-2158.

<sup>343</sup> Ibid.

<sup>344</sup> Human Rights Watch interview with Saadi, Tripoli, Libya, March 14, 2012.

<sup>345</sup> Ibid.

<sup>346</sup> Ibid.

Saadi said he was held without charge at the Tajoura prison for approximately three years, much of that time in solitary confinement. Then on December 15, 2007, he was moved to Abu Salim prison, where he was held until March 23, 2010.<sup>347</sup> During his time at Tajoura, Libyan authorities interrogated him sporadically and at times beat him. The interrogations usually started at 5 a.m. and went until noon. He said he was not treated badly during the first month in custody and was even led to believe that he would be released in a matter of days. But after that, the treatment got worse. He said he was hit with a black wooden stick that was just over a foot long, whipped with a rope, slapped, kicked, punched, and administered electric shocks on the neck, chest, and arms. He estimates that he was shocked 15 times. After about a year and a half at Tajoura, Saadi noted that the abuses began to lessen. He thought that this might have been because of increased cooperation with the Americans and a commitment by the Libyan authorities as part of that cooperation to not use force. He added, however, that when interrogators got angry, they still seemed to have a “green light to start” physically abusing him.

Saadi told Human Rights Watch,

The beatings took place outside the cell and outside the interrogation room—it was a room just for beating and torture.... The beatings were random, not regular. For example, after an interrogation, if they weren’t satisfied, I found myself in a different room and the torture and beating would start. It would be a different group doing that [the beating] but sometimes the interrogators would be there just watching.

During his time at Tajoura, Saadi said, he was interrogated by Libyan, American, British, and Italian intelligence agencies, as well as some agents who spoke French, though he did not know if they were French.

The interrogators Saadi believes were American questioned him twice: once immediately after he arrived in Libya and again four or five months later. The first team of Americans consisted of two interrogators, a man named Joe or John, who was short and thin, and a woman in her 40s. He said, “It seemed that this lady was specialized in Libyan files

---

<sup>347</sup> Ibid.

because she knew everything about the Libyan guys—their fake names, their true names, everything.” For the first part of the interrogation, Musa Kusa was present in the room, but he eventually left the room “angrily” over Saadi’s denials that he and his group were the same as al Qaeda. “He was telling them that there was no difference between our group and al Qaeda and that we are dangerous not only for Libyans but for Westerners especially.” They questioned Saadi for several hours over one day, asking him about his time in China and one of the Libyans living in the UK. He said they did not physically abuse him.

The second group of American interrogators—a team of five—consisted of the same short thin man, another man, and three women, including the interpreter. This time the questions were much more specific and lasted all day, until past midnight.

Sometime between the first and second visit by American interrogators, a team of two that Saadi believes were from the United Kingdom questioned him—a man in his 30s with brown hair and a short beard and a woman in her 40s who was thin and blond. He said the British interrogation was short and focused more on the LIFG’s ideology.

Saadi said the French-speaking agents questioned him about a year into his imprisonment and that the “nicest” interrogators were the Italians. “They were so decent with me,” he said. They asked “for permission” to interrogate him and explained that “it would be very useful to know” certain things. “They knew I had met Osama bin Laden and wanted to know more about this. They also asked my opinions about things like whether or not I thought their presence in Iraq would result in retaliations against Italy.”

In 2009, Saadi was charged with 14 crimes, including attempting to overthrow the government and spreading ideology against the revolution. His trial took place in the prison and he was convicted and sentenced to death. Saadi was released on March 23, 2010 as part of the same negotiated release that freed Belhadj, Sharif, and other prisoners (see above). Yet after the uprisings against Gaddafi began in February 2011, he was arrested again, along with his son, and held until August 2011, when rebel forces captured Tripoli.

In October 2011, Saadi filed a lawsuit against the British government (the security services, the attorney-general, the Foreign and Commonwealth Office, and the Home Office) for their

complicity in his transfer back to Libya.<sup>348</sup> In January 2012 Saadi, along with Belhaj, also filed a civil suit against MI6's former head of counter-terrorism, Sir Mark Allen, accusing him of complicity in torture, misfeasance in public office, and negligence.<sup>349</sup> Then on June 17, 2012, Saadi filed a claim against the government of Hong Kong for its role in his transfer.<sup>350</sup> Saadi now lives in Tripoli with his family. He is an imam at a local mosque and founded a political party, al-Umma al-Wasat. He ran, as did Belhadj, as a candidate during the July 7, 2012 elections. But his party, along with many other smaller ones, was defeated by the National Forces Coalition party headed by Mahmoud Jibril.<sup>351</sup>

---

<sup>348</sup> "Leigh Day Represent Victim of Gaddafi Regime," Leigh Day & Co. news release, October 25, 2011, <http://www.leighday.co.uk/News/2011/October-2011/Leigh-Day-Represent-Victim-of-Gaddafi-Regime> (accessed May 28, 2012).

<sup>349</sup> "Libyan politician questioned by British police over rendition allegations," Leigh Day & Co Solicitors news release, July 19, 2012, <http://www.leighday.co.uk/News/2012/July-2012/Libyan-politician-questioned-by-British-police-ove>, (accessed August 28, 2012).

<sup>350</sup> "Libyan rendition victim Sami al Saadi launches legal action against Hong Kong," Reprieve news release, June 17, 2012.

<sup>351</sup> Omar Ashour, "Libya's Defeated Islamists," July 17, 2012, <http://www.project-syndicate.org/commentary/libya-s-defeated-islamists> (accessed on July 18, 2012) (In response to the election results Saadi stated, "We certainly did not expect the results, but ... our future is certainly better than our present and our past."); see also Aymehh Jawad al-Tamimi, "Rethinking Libya," *The American Spectator*, July 12, 2012, <http://spectator.org/archives/2012/07/12/rethinking-libya> (accessed July 25, 2012).



Muhammed Abu Farsan  
© 2012 Human Rights Watch

## Muhammed Abu Farsan

Muhammed Abu Farsan (Abu Farsan)<sup>352</sup> was a member of the LIFG who left Libya in 1990. He spent a decade in Libyan opposition training camps in Afghanistan and Sudan. After the September 11 attacks, Abu Farsan traveled to multiple countries with his family seeking asylum. While in transit in the Netherlands on the way from China to Morocco, he sought asylum in the Netherlands but his asylum claims were ultimately denied. The Netherlands deported Abu Farsan and his family to Sudan, where he was taken into custody. Abu Farsan said that in Sudan he was interrogated by Sudanese authorities and by a man who introduced himself as being with the CIA. After two weeks the Sudanese transferred him to Libya, where he spent several years in Libyan detention and was subjected to prolonged solitary confinement and repeated interrogations by Libyan authorities. Ultimately he was charged and tried for his involvement with the LIFG, convicted, and sentenced to life in prison. He was detained in Libya until February 16, 2011, as the uprisings against Gaddafi began.

Human Rights Watch interviewed Muhammed Abu Farsan in Tripoli in March 2012. The following account and quotes are drawn from this interview unless otherwise noted.<sup>353</sup>

### *Departure from Libya*

In 1982, when Muhammed Abu Farsan was about 18, he joined the police department. In 1988, against his will, he was transferred to the military. During his military service, he said, he came under pressure because of his religious beliefs. The military was a secular institution and he said those who were devout Muslims were held in suspicion. At some point during his military service, he was arrested and detained for a month. In June 1990, he suspected the security service was looking for him again, so he decided to leave Libya.

---

<sup>352</sup> Muhammed Abu Farsan's name is sometimes spelled "Mohammed Abu Fursin" or "Abufersin." He has also gone by the name of Abu Zinad.

<sup>353</sup> Human Rights Watch interview with Muhammed Abu Farsan, Tripoli, Libya, March 26, 2012.



Abu Farsan spent the next decade at Libyan opposition training camps in Afghanistan and Sudan, with brief visits to Egypt, Malta, Saudi Arabia, and Syria. He told Human Rights Watch, “Afghanistan was a good place for the Libyans to train to get new skills to fight Gaddafi. At the time there was no other country that allowed us to be together and train.” In 1994, he returned to Libya to visit family and stayed for two years, much of it in hiding. Then in June 1996, he left again, this time going to Sudan to train with the LIFG. He spent about five years in Sudan and got a Sudanese passport. In May 2001, he went to Syria and got married, and then shortly afterwards he went to Afghanistan.

When he arrived in Afghanistan, Abu Farsan said, everyone at the various training camps knew that al Qaeda was planning some sort of operation against the United States. He said there was an open debate about it amongst all of the various groups. Even many al Qaeda Arabs did not agree with bin Laden’s methods, he said: “The LIFG did not want anything to do with it. We did not agree with these actions, but Afghanistan was a refuge for all wanted people.” After the September 11 attacks, Abu Farsan said he spent the next several months “running around all over the place trying to find some safe refuge.”

He went first to Pakistan, then to Syria and Iran. Along the way, his wife gave birth to a son, so he returned to Sudan to add his son to his passport. He spent the next few years on the move, moving back and forth among Syria, Iraq, Malaysia, and China. “I was worried constantly I was going to get caught any minute,” he said. During this period, he was in contact with Belhadj and Saadi, who were also in Asia at the time.

In early 2004, he decided to seek asylum in Europe. On February 19, 2004, traveling with Moroccan passports, Abu Farsan, his wife, and his infant son, boarded a KLM flight bound for Morocco via the Netherlands. “I thought that if I made it to Holland and asked for asylum, I would be okay there. My son was less than two years old,” Abu Farsan said. When he arrived in the Netherlands, the Dutch authorities held him for six months while they entertained his asylum application. The Dutch authorities found his Sudanese passport and were trying to insist he was Sudanese but he told them that he was in fact Libyan but could not get Libyan documentation from the Libyan government. He applied for asylum based on his Libyan nationality saying he could not return to that country. The Dutch authorities appear to have given his application consideration. He was provided a lawyer and took part in immigration proceedings. At one point he said he was asked to



They noted in the fax that they understood he was currently in Dutch custody and indicated their intention to share information with the Dutch government. British intelligence stated, “We would like to share the information on Abu Zinad with Dutch liaison in The Hague in case they can assist us in identifying Abu Zinad if he is there.”<sup>355</sup> Four months later, on August 9, 2004, Abu Farsan and his family were deported to Sudan. He knew it was likely that less developed countries would have fewer qualms than Western governments about sending him back to Libya, so he was very concerned that if he was sent to a non-Western country he would in fact be returned. He said he protested strongly. “In the court I asked if they were going to transfer me to Libya,” he told Human Rights Watch. “I told them, if you are going to send me anywhere else, I am going to end up in Libya, so why not just send me to Libya directly?”<sup>356</sup>

The Netherlands sent Abu Farsan to Khartoum around August 7 or 8. His wife and son appear to have been with him. His son was about one year old at the time. After a night in Nairobi, they arrived in Khartoum on August 9, 2004. Sudanese authorities took him to a detention facility and interrogated him for three days. On the fourth day, they took him to what he describes as a “large building with air conditioning,” where two Sudanese officials and an American—who introduced himself as being from the CIA—interrogated him. Abu Farsan said the American agent was tall, in his early thirties, had an athletic build, spoke very good Arabic “in a way I could completely understand,” and “had a beard like Mohammed.”

Abu Farsan said that the CIA agent interrogated him three times, asking him about the LIFG and its relationship with al Qaeda. He told him that the British also had a lot of intelligence on him but Abu Farsan said he was not interrogated by British agents. At first, the CIA agent was very polite, but when Abu Farsan did not provide the answers he wanted, the agent began threatening that he would be sent to Libya. The CIA agent insisted that Libya

---

<sup>355</sup> Ibid.

<sup>356</sup> The UN Committee against Torture has held that under article 3 of the Convention against Torture, which prohibits the return or extradition of a person to another state where there are substantial grounds for believing that he would be subjected to torture, the risk of torture must be assessed not just for the initial receiving state, but also to states to which the person may be subsequently expelled, returned, or extradited. UN Committee against Torture, “Implementation of article 3 of the Convention in the context of article 22,” General Comment No. 1, U.N. Doc. 11/21/1997.A/53/44, annex IX, CAT General Comment No. 01. (General Comments), [http://www.unhcr.ch/tbs/doc.nsf/\(Symbol\)/13719f169a8a4ff78025672b0050eba1?Opendocument](http://www.unhcr.ch/tbs/doc.nsf/(Symbol)/13719f169a8a4ff78025672b0050eba1?Opendocument) (accessed June 26, 2012), para. 2.

“He told me, we will bring all of you. We have Belhadj and Saadi. We will get you all and bring you here.”

would not be any worse than Guantanamo or Abu Ghraib prison in Iraq. Abu Farsan said the American agent never physically abused him.

In total, Abu Farsan was in Sudanese custody for about two weeks. He spent much of that time on a hunger strike because the authorities would not tell him where his wife and son were. Then, on the morning of August 21 or 22, he was told that he would be going back to Libya. He was taken to a plane with Libyan intelligence agents on board. At some point his family came on board as well. They were all flown together to Tripoli.

### *Treatment in Libya*

Upon arrival in Tripoli, he was again separated from his wife and child and taken to the external affairs building at the Tajoura prison. Abu Farsan said that on the first day, he was brought to see Musa Kusa:

“He told me, we will bring all of you. We have Belhadj and Saadi. We will get you all and bring you here.”

For 16 months, Libyan authorities held him in isolation in a dark cell “about the size of a mattress.” He had no idea what had happened to his family. He was forbidden from speaking to other prisoners, and the only time he was taken out of his cell was for interrogation. Abu Farsan said that for the first month, Libyan agents interrogated him constantly, day and night. After the first month, he was not interrogated again, though he said sometimes Libyan intelligence agents would show him photographs of people and ask if he knew anything about them. Foreign intelligence agents never interrogated him.

On December 23, 2004, Abu Farsan was taken out of Tajoura prison. For the next year-and-a-half, he was transferred back and forth between the Sikka and Enzara prisons. During that time, he was told that his wife and son were in Libya, and he was allowed to see them. He was also during this period tried and convicted for being a member of the LIFG, possessing fake documents, participating in the Afghan jihad, and providing material support to the LIFG. On March 15, 2006, Abu Farsan was sentenced to life in prison.

On June 7, 2006, Abu Farsan was transferred to Abu Salim prison. At Abu Salim, Abu Farsan said conditions were a little better than at Tajoura. His cell was slightly bigger and he was allowed to bathe, and the ventilation was better. But he was still kept in isolation most of the time. He was at Abu Salim when a riot broke out in October 2008. One of his friends was killed and five others injured when the government violently suppressed it.

Overall, Abu Farsan said that the conditions of his detention were better than those experienced by others he knew who had been detained in earlier years. During his period, he said, the Libyan authorities were being easier on prisoners as they opened relations with the West and prepared for Gaddafi's son, Saif Gaddafi, to come to power. Conditions at Abu Salim in particular started to improve when Belhadj, Saadi, and Khalid Sharif began negotiating with the government for the release of prisoners.<sup>357</sup> Abu Farsan was released on February 16, 2011.

---

<sup>357</sup> See above, "Libyan Islamic Fighting Group" part of the "Background" section.

## IV. Transfer from Guantanamo Bay: The Case of Abdusalam Abdulhadi Omar as-Safrani

Abdusalam Abdulhadi Omar as-Safrani (Safrani)<sup>358</sup> is one of two Libyans detained by the United States at the military detention facility at Guantanamo Bay and then returned to Libya by the US.<sup>359</sup> He asked not to be sent back to Libya, but the United States ignored these requests.

Human Rights Watch interviewed Abdusalam Abdulhadi Omar as-Safrani in Benghazi in March 2012. The following account and quotes are drawn from this interview unless otherwise noted.<sup>360</sup>

### *Departure from Libya*

Safrani told Human Rights Watch that he left Libya in 1990 because of the enormous pressure the Gaddafi government was putting on those committed to Islam. He first went to Saudi Arabia, but without proper papers it was difficult to remain. He went to Pakistan and then Afghanistan. He said he was not a member of the LIFG or al Qaeda and he went to Afghanistan as an immigrant, not to fight against the Soviet-installed government, as did other Libyans.<sup>361</sup> Others detained with Safrani in Guantanamo corroborate that Safrani was not a fighter.<sup>362</sup> Records from Guantanamo also indicate that he had “congenital clubbed feet.”<sup>363</sup> Abu Zubaydah, a Saudi currently held at Guantanamo who apparently knew

---

<sup>358</sup> Abdusalam Abdulhadi Omar as-Safrani also went by the names of “Mohammed Rimi,” Abdallah Mansur al-Rimi, and Muhammad Abd Allah Mansur al Futuri.

<sup>359</sup> Safrani is one of 10 Libyans the US detained in Guantanamo. Two, including Safrani, were sent back to Libya; one was transferred to Albania, one to the UK, and two to the country of Georgia. The other four continue to be held at Guantanamo. See “The Guantanamo Docket: Citizens of Libya,” *New York Times*, <http://projects.nytimes.com/guantanamo/country/libya> (accessed July 27, 2012).

<sup>360</sup> Human Rights Watch Interview with Safrani, Benghazi, Libya, March 20, 2012.

<sup>361</sup> Though Safrani said he was not a member of the LIFG when he was arrested, according to US intelligence reports assembled in what is called a Risk Assessment file for Safrani, some other LIFG members and others captured by the US and detained in Guantanamo have said that he was a LIFG member some years earlier. See “The Guantanamo Files,” Risk Assessment File for Prisoner 194, [wikileaks.org](http://wikileaks.org), <http://wikileaks.org/gitmo/prisoner/194.html#> (accessed June 22, 2012), p.5.

<sup>362</sup> *Ibid.*

<sup>363</sup> *Ibid.*, p. 1.

Safrani in Afghanistan, said that though Safrani was at a training camp, he was just simply “sitting with the brothers.... [Safrani was a] simple person who could not make explosives and had bad security.”<sup>364</sup>

After the US invasion of Afghanistan following the September 11 attacks, Safrani fled Afghanistan to Pakistan, where he was apprehended by Pakistani security forces. He was first taken to Kohat prison, where he was held for two weeks by the Pakistani military. There he was interrogated by Americans in civilian clothes who took pictures of him. After two weeks he was transferred to US custody and taken to Kandahar in Afghanistan. There, he said, US personnel interrogated him continually and deprived him of sleep. His cell was in a tent and he was detained with about 10 to 15 other detainees. He said it was very cold and there was no heat and not enough food. “This was January,” he told Human Rights Watch. “They gave us only one blanket for each prisoner and it wasn’t warm enough.” The Americans held him there for approximately six weeks and then transferred him to Guantanamo Bay.

### *Transfer to Guantanamo*

He said the 18-hour transit to Guantanamo was rough. He was transported with a large group. Their heads were shaven and they were dressed in orange jumpsuits, hooded, and required to wear headphones and black glasses to block sound and sight. Safrani was only told he was being taken to a US Navy base but not told where. He only later figured out he was in Guantanamo. He was given a blanket, toothbrush, and towel and then put in a cell that was about 2 x 1 meters, where he was held for the next three months. It had a wooden ceiling, held up by four pipes from each corner of the room, mesh walls, and a concrete floor. There was no toilet in the cell, just a bucket.

After about three months, he was moved by bus to another detention facility at Guantanamo, where he was detained for the next five years. He described this facility as a hangar, with galvanized steel walls and a slanted roof. His cell was about the same size as his prior one—the main difference being the walls were not mesh and the lights were on 24 hours per day. The Americans also played voices and sounds over a loudspeaker between 7 a.m. and about 1 p.m. and would sometimes bang on the galvanized steel sheets to make noise.

---

<sup>364</sup> Ibid., p. 5.

This prevented him from sleeping and occurred almost daily for the entire five years he was there.

He said US guards beat him on several occasions, once fracturing his shoulder. Another time guards used “a hose, putting water on our faces, so you feel like drowning.” The International Committee of the Red Cross visited him on several occasions, and he heard from his family by letter for the first time three years into his detention. Safrani said that when the US personnel deemed him uncooperative, he was put in a room that was extremely cold. The air conditioning was turned on high and the Americans interrogated him the entire time. He was in the cell 20 to 30 times, and the longest time he spent in the room was 30 days.<sup>365</sup>

He said that over time, conditions improved. He was allowed to participate in sports about two to three times weekly in the beginning, and then eventually daily. The rule eventually became that detainees were to get up to 30 minutes of exercise per day, but often he was only allowed five minutes, which he said was a form of punishment.

### *Transfer and Treatment in Libya*

When Safrani learned he was being returned to Libya, he asked his captors for asylum or resettlement in a third country. This request was denied, and on December 15, 2006, he was transferred to Libya.<sup>366</sup> He was initially held in Tajoura for six months, then moved to al Nasser bureau for approximately 45 days, and finally to Abu Salim prison until his release.

He said he was physically abused while detained in Libya. He said the Libyan authorities used electrical shocks several times on his hands, legs, and sensitive areas of his body. He was whipped on his back, kicked, punched, and slapped. He suffered pain from a toothache and was denied pain relief for one year. After several years of detention, Safrani was charged with being a member of LIFG and al Qaeda. He was appointed a lawyer and was in court about three or four times. Ultimately he was convicted and sentenced to life in prison. He was released on August 24, 2011 after the fall of Gaddafi.

---

<sup>365</sup> The first time he was in the cell was for 5 days, then 10 days. The longest amount of time was 30 days.

<sup>366</sup> Safrani did not know his exact date of transfer, but Guantanamo records indicated it was on December 15, 2006. See “The Guantanamo Docket,” *New York Times*, <http://projects.nytimes.com/guantanamo/country/libya> (accessed May 27, 2012).



## V. The Case of Ibn al-Sheikh al-Libi

*Ibn al-Sheikh al-Libi, whose real name is Ali Mohamed al-Fakheri, was a Libyan taken into custody in the Afghanistan-Pakistan border area in late 2001. He was held in secret CIA detention for years and subjected to abusive interrogations on numerous occasions in different locations. During a coercive interrogation by US personnel in Egypt, al-Libi provided false information about Iraq having agreed to provide two al Qaeda operatives with chemical or biological weapons training. Then-US Secretary of State Colin Powell cited this as a key piece of evidence during his historic speech to the United Nations on February 5, 2003, when trying to rally international support for an invasion of Iraq. Al-Libi later recanted these facts, and the CIA itself later deemed them unreliable. After years in secret CIA custody, al-Libi was subsequently sent back to Libya. He died in a prison cell in Libya on May 9, 2009. Libyan authorities claimed he committed suicide.*

Ibn al-Sheikh al-Libi was born in Ajdabiya, Libya in 1963. He left Libya in 1986, in his early 20s. According to his family, he left mostly because he wanted to study classical Arabic and travel, not necessarily because he opposed the Gaddafi government.<sup>367</sup> “At that time, all Libyans were dissatisfied with the regime,” his brother, Abdul Aziz al-Fakheri, told Human Rights Watch. “But in al-Libi’s case opposition to Gaddafi was not the main reason he left Libya.... He just wanted to see the world, to be a tourist.”<sup>368</sup> He first went to Mauritania, where there were a number of highly trained and respected sheikhs specializing in classical Arabic, as well as Islamic studies and Islamic history.<sup>369</sup>

In Mauritania, while at the Libyan embassy, the consular officials confiscated his passport.<sup>370</sup> His family said al-Libi told them the Libyans did this because they assumed that since he was living abroad, he was opposed to Gaddafi.<sup>371</sup> Without his passport, travelling became difficult. From Mauritania, for the next four years, he traveled on foot, according to

---

<sup>367</sup> Human Rights Watch interview with Abdul Aziz el-Fakhri, brother of Sheikh al-Libi, Ajdabiya, Libya, March 22, 2012; and Faraj el-Fakhri, nephew of Sheikh al-Libi, Benghazi, Libya, March 21, 2012.

<sup>368</sup> Human Rights Watch interview with Abdul Aziz el-Fakhri, March 22, 2012.

<sup>369</sup> Human Rights Watch Interview with Faraj el-Fakhri, March 21, 2012.

<sup>370</sup> Human Rights Watch interview with Abdul Aziz el-Fakhri, March 22, 2012.

<sup>371</sup> Ibid. Abdul Aziz el-Fakhri also said this was partially because the Libyans had tried to get al-Libi to spy for them during this time but he refused.

his brother, to many different countries in the region including Ghana, Senegal, Morocco, and Algeria.<sup>372</sup>

Eventually he went to Saudi Arabia, where he joined jihadists fighting the Soviet-installed government in Afghanistan.<sup>373</sup> He also may have spent some time in Syria studying engineering.<sup>374</sup> Eventually he became the head of the Khalden training camp in Afghanistan, which pre-dated al Qaeda and was not known to be aligned with any particular group.<sup>375</sup> Various Islamist armed groups trained there, not just al Qaeda. While al-Libi has been labeled both a senior LIFG member and a senior al Qaeda operative, the evidence suggests that he was not a member of either armed group.<sup>376</sup> Some sources said that he strongly disagreed with al Qaeda's philosophy and did not like Bin Laden.<sup>377</sup> "For [al-Libi], his time in Afghanistan was more about a man making his way in the world, making a living," said al-Libi's brother el-Fakhri. "It wasn't because he agreed with al Qaeda or their ideological thoughts ... absolutely not."<sup>378</sup>

---

<sup>372</sup> Human Rights Watch interview with Abdul Aziz el-Fakhri, March 22, 2012.

<sup>373</sup> Human Rights Watch interview with Abdul Aziz el-Fakhri, March 22, 2012.

<sup>374</sup> Michael Isikoff and David Corn, *Hubris*, (New York: Crown, 2006), p. 119.

<sup>375</sup> Soufan, *The Black Banners*, p. 132 ("Khaldan predated al-Qaeda, having been established during the Afghan jihad against the Soviets.... Khaldan was known to be an independent camp."). See also Omar Nashiri (pseudonym), *Inside the Jihad: My Life with Al Qaeda* (New York: Basic Books, 2006), p. 102-242.

<sup>376</sup> "Neither [Khaldan's] external emir, Abu Zubaydah, nor its internal emir, Ibn al-Shaykh al-Liby was a member of al-Qaeda and these emirs prized their independence." Soufan, *The Black Banners*, p. 132. At one point during his interrogation al-Libi said he was a member of al Qaeda but later in 2004, he said he only said that so that his treatment by the Americans would improve, which it did. Senate Select Committee on Intelligence (SSCI), "Postwar Findings about Iraq's WMD Programs and Links to Terrorism and How They Compare with Prewar Assessments," September 8, 2006, ("SSCI – Sept. 8, 2006 Report") p. 80. <http://intelligence.senate.gov/phaseiiaccuracy.pdf> (accessed June 2, 2012).

<sup>377</sup> "Al-Libi was not a member of our group," Shoroeyia, a senior LIFG member, said during a Human Rights Watch interview in Tripoli, Libya, on March 18, 2012;

"[Al-Libi] told me specifically that he thought al Qaeda was bad for Islam, that he did not agree with their philosophy, and that he especially did not agree with the attack on the US." Human Rights Watch telephone interview with Mohammed Bousidra, who was detained with al-Libi in the Foreign Intelligence Building (Bousidra in cell three and al-Libi in cell seven), April 2, 2012; see also Human Rights Watch interview with Abdul Aziz el-Fakhri, March 22, 2012;

When members of an FBI team were interrogating al-Libi, before the CIA stepped in and before enhanced interrogation methods were used, "it emerged that [al-Libi] hadn't actually liked bin Laden, who had tried to force him to train only al-Qaeda fighters, not all Muslims, which was his preference." Jane Mayer, *The Dark Side* (New York: Anchor Books, 2009) p. 105.

<sup>378</sup> Human Rights Watch interview with Abdul Aziz el-Fakhri, March 22, 2012;

"Al-Libi had very good relationships with all the groups. He was learning, teaching, and fighting and his mantra was to be loyal to whoever he was working for, to the place where he was. For him it was a job." Human Rights Watch telephone interview with Bousidra, April 2, 2012.

In late 2001, Pakistani authorities apprehended al-Libi and turned him over to US custody, which transferred him to the US-run detention and interrogation facility at Bagram.<sup>379</sup> At Bagram he was interrogated by FBI agents, who reportedly developed a rapport with him to the point where he was asking for asylum in the US and agreeing to testify in other cases.<sup>380</sup> After this, however, the CIA, believing they could obtain even more information from him with harsher interrogation techniques, took control of the interrogation over FBI objections.<sup>381</sup> Afterwards, the CIA sent al-Libi to Egypt, where he was subjected to ill-treatment by Egyptian authorities,<sup>382</sup> which produced false information linking Saddam Hussein with al Qaeda.<sup>383</sup>

Specifically, the interrogators questioned al-Libi about al Qaeda's connections to Iraq, a subject about which al-Libi said he knew nothing and had difficulty even coming up with a story.<sup>384</sup> His interrogators reportedly did not like his response. Al-Libi said he was then put in small box, approximately 50 x 50 centimeters (20 by 20 inches—the depth of the box was not provided), for about 17 hours, “knocked over with a thrust across the chest,” and then “punched for 15 minutes.”<sup>385</sup> After this, he came up with a story about Iraq having agreed to provide two al Qaeda operatives with chemical or biological weapons training.<sup>386</sup>

---

<sup>379</sup> Mayer, *The Dark Side*, p. 104; Isikoff and Corn, *Hubris*, p. 120.

<sup>380</sup> Some of the intelligence gathered during these sessions was information about 1) an al Qaeda plot to blow up the US Embassy in Aden, Yemen; 2) Richard Reid, the so-called “shoe bomber,” who attempted to detonate plastic explosives during a flight from Paris to Miami on December 20, 2001; and 3) co-conspirator in the September 11 attacks Zacarias Moussaoui. Mayer, *The Dark Side*, p. 104-06; Isikoff and Corn, *Hubris*, p. 120-24.

<sup>381</sup> According to FBI sources who described the incident to some journalists, while FBI officer Russell Fincher, who had established a bond with al-Libi, was questioning him, a CIA officer named “Albert” stormed in and started shouting at al-Libi. “You’re going to Egypt!” he yelled. While there, he said to al-Libi: “I’m going to find your mother and f--- her.” Isikoff and Corn, *Hubris*, p. 120-21. (The accounts of Isikoff and Mayer differ only slightly).

<sup>382</sup> “We believed that al-Libi was withholding critical threat information at the time, so we transferred him to a third country for further debriefing.” George Tenet and Bill Harlow, *At the Center of the Storm: My Years at the CIA* (New York: Harper Collins, 2007), p. 353. Earlier in his book, Tenet says that al-Libi provided information to the Egyptians about a nuclear threat that he later recanted—indicating that the “third country” in question was indeed Egypt. Tenet, *At the Center of the Storm*, p. 269.

<sup>383</sup> US Senate Select Committee on Intelligence, “Postwar Findings about Iraq’s WMD Programs and Links to Terrorism and How They Compare with Prewar Assessments,” September 8, 2006, (“SSCI Sept. 8, 2006 report”), <http://intelligence.senate.gov/phaseiiaccuracy.pdf> (accessed June 2, 2012), p. 82.

<sup>384</sup> SSCI Sept. 8, 2006 Report, p. 82. See also Isikoff and Corn, *Hubris*, p. 424.

<sup>385</sup> SSCI Sept. 8, 2006 Report, p. 81. Ibid.

<sup>386</sup> SSCI Sept. 8, 2006 Report, p. 80-81; Isikoff and Corn, *Hubris*, p. 424.

Then-US President George W. Bush used this information in an October 2002 speech about Iraq.<sup>387</sup> And Secretary of State Colin Powell used it as a key piece of evidence during his historic speech to the United Nations on February 5, 2003, when he tried to rally international support for an invasion of Iraq.<sup>388</sup> But over a year earlier, the US Defense Intelligence Agency (DIA) had already discredited the information. A February 22, 2002, DIA cable stated,

This is the first report from Ibn al-Shaykh [al-Libi] in which he claims Iraq assisted al-Qa'ida's CBRN [chemical, biological, radiological, and nuclear] efforts.... It is possible he does not know any further details; it is more likely this individual is intentionally misleading the debriefers. Ibn al-Shaykh has been undergoing debriefs for several weeks and may be describing scenarios to the debriefers he knows will retain their interest. Saddam's regime is intensely secular and is wary of Islamic revolutionary movements. Moreover Bagdad is unlikely to provide assistance to a group it cannot control.<sup>389</sup>

Powell later indicated he regretted using the information during his UN speech.<sup>390</sup> Although senior Bush administration officials would likely have been aware that the information was not credible, they did not share this with Powell before his speech.<sup>391</sup> Indeed, in January

---

<sup>387</sup> "President Bush Outlines Iraqi Threat: Remarks by the President on Iraq," speech by President George W. Bush, Cincinnati Union Terminal, Cincinnati, Ohio, October 7, 2002, transcript available at <http://georgewbush-whitehouse.archives.gov/news/releases/2002/10/20021007-8.html> (accessed August 29, 2012).

<sup>388</sup> Isikoff and Corn, *Hubris*, p. 187. See also Michael Hirsh, John Barry, and Daniel Klaidman, "A Tortured Debate," *Newsweek*, June 21, 2004. Al-Libi was a principal source for Bush administration claims that al Qaeda collaborated with Saddam Hussein, particularly the assertion by Secretary of State Colin Powell to the United Nations that Iraq had provided training in "poisons and gases" for al Qaeda. See also "A Policy of Evasion and Deception: Speech to the United Nations on Iraq," speech by Colin Powell, the United Nations, February 5, 2003, transcript available at [http://www.washingtonpost.com/wp-srv/nation/transcripts/powelltext\\_020503.html](http://www.washingtonpost.com/wp-srv/nation/transcripts/powelltext_020503.html) (accessed June 3, 2012).

<sup>389</sup> SSCI Sept. 8, 2006 Report, p. 77.

<sup>390</sup> Steven R. Weisman, "Powell Calls His U.N. Speech a Lasting Blot on His Record," *Washington Post*, September 9, 2005, <http://www.nytimes.com/2005/09/09/politics/09powell.html> (accessed June 2, 2012) (quoting Powell in an interview saying it was "devastating" to learn that some intelligence agents knew the information he had was unreliable but did not speak up).

<sup>391</sup> A "well-informed Republican source familiar with the details," told Jane Mayer that "top CIA officials had to have known about the warnings. 'The entire intelligence community would have had access to the DIA analysis. If you were on Intel-Link'—the classified government computer system—"anyone reading about that case would see it," [the Republican source familiar with the details] said." Mayer, *The Dark Side*, p. 137.

See also SSCI Sept. 8, 2006 Report, p. 76-78; and Letter from to John D. Rockefeller IV, vice chairman, Senate Select Committee on Intelligence, to Vice Admiral Lowell E. Jacoby, director, Defense Intelligence Agency, October 18, 2005,

2004, al-Libi recanted the information, saying he “lied to the [foreign government service] about future operations to avoid torture.”<sup>392</sup> No other credible evidence was ever produced confirming Iraq had trained al Qaeda in the use of chemical or biological weapons.<sup>393</sup>

For years after US forces initially detained him, al-Libi was forcibly disappeared. Human Rights Watch and numerous other nongovernmental organizations called upon the US government to disclose al-Libi’s location, as well as the location of many other “disappeared” prisoners in the “global war on terror.”<sup>394</sup> When President Bush finally admitted the existence of a secret CIA detention program and transferred 14 formerly secret detainees held by the CIA to Guantanamo on September 6, 2006, al-Libi was noticeably missing from the list.

In late 2006 and early 2007, Human Rights Watch and several journalists received reports from Libyans in exile that al-Libi and several other Libyans who had been in US custody had been rendered to Libya. The exact date of al-Libi’s transfer is not clear. During a research trip to Libya in 2009, Human Rights Watch was able to confirm that al-Libi had indeed been transferred and was being detained at Abu Salim prison in Tripoli.<sup>395</sup> Human Rights Watch saw al-Libi for a few minutes and tried to interview him. He appeared agitated and angry but he sat down with researchers and listened to a short introduction about Human Rights Watch. However, before he could be interviewed, al-Libi got up and said before walking away, “Where were you when I was being tortured in American jails?”<sup>396</sup>

---

<http://www.fas.org/irp/news/2005/11/DIAletter.102605.pdf> (accessed June 2, 2012) (declassifying a Defense Intelligence report from February 2002 which indicates that the information al-Libi was supplying was not reliable); and Larry Siems, *The Torture Report* (New York and London: OR Books, 2011), p. 337-338.

<sup>392</sup> SSCI Sept. 8, 2006 Report, p. 80.

<sup>393</sup> *Ibid.*, p. 82.

<sup>394</sup> Human Rights Watch, *The United States’ “Disappeared”: The CIA’s Long-Term “Ghost Detainees,”* October 12, 2004 <http://www.hrw.org/reports/2004/10/12/united-states-disappeared-cias-long-term-ghost-detainees> (first on the list of 11 known prisoners missing at the time was Ibn Shiekh al Libi); Human Rights Watch, *List of “Ghost Prisoners” Possibly in CIA Custody*, November 30, 2005, <http://www.hrw.org/reports/2005/11/30/list-ghost-prisoners-possibly-cia-custody> (first on the list of 26 known prisoners missing at the time was Ibn Sheikh al-Libi); Human Rights Watch, *Ghost Prisoner: Two years in Secret CIA Detention*, Vol. 19, No. 1(G), February 27, 2007, <http://www.hrw.org/reports/2007/02/26/ghost-prisoner> (first on the list of 38 of known prisoners missing at the time was Ibn Sheikh al Libi); and Human Rights Watch, “Letter to Bush Requesting Information on Missing Detainees,” February 27, 2007, <http://www.hrw.org/news/2007/02/26/letter-bush-requesting-information-missing-detainees>.

<sup>395</sup> “Libya/US: Investigate Death of Former CIA Prisoner,” Human Rights Watch news release, May 11, 2009, <http://www.hrw.org/news/2009/05/11/libyaus-investigate-death-former-cia-prisoner>.

<sup>396</sup> *Ibid.* Human Rights Watch interviewed other prisoners during this visit who had been in CIA custody, several of whom are interviewed for this report, including Belhadj, Shoroeiya, Maghrebi, and Mehdi (see above). Some of these interviews were

Human Rights Watch and other human rights organizations had strongly condemned the secret CIA detention program and had been trying for years to get access to forcibly disappeared prisoners as well as those at Guantanamo, but without success. Two weeks after Human Rights Watch saw al-Libi at Abu Salim, Libyan authorities reported that he committed suicide in his cell, a claim that merits a thorough investigation.<sup>397</sup>

There is limited information available about the US detention of al-Libi. While researching this report, Human Rights Watch tried to develop a clearer picture with information from family members and prisoners with whom he was held. He apparently was taken into custody near the border between Pakistan and Afghanistan at the end of 2001, though different dates have been reported.<sup>398</sup> Adusalam Abdulhadi Omar as-Safrani, another Libyan interviewed for this report (see above) who was apprehended in the same area around the same time, said he saw al-Libi in detention in Kohat, Pakistan, in December 2001. He had been taken there a day or two after the Pakistani army detained him just inside the Pakistan border. He was not sure of the exact date, but by the time he had arrived in Kohat, al-Libi was already there.<sup>399</sup> About 300 other prisoners were also being held in the same facility. Al-Libi had been initially detained by tribes in the area, who then turned him over to Pakistani authorities.<sup>400</sup>

After Safrani was there for about two weeks, “the Americans” came. They were in civilian clothes, not military uniforms, and Safrani believes they were CIA. They interrogated him and later moved him, al-Libi, and the rest of a big group from Kohat to Kandahar. In Kandahar, al-Libi was identified as a commander and split from the rest of the group.<sup>401</sup> That was the last time Safrani saw al-Libi. Safrani was then taken to Guantanamo, where he was

---

included in Human Rights Watch, *Libya – Truth and Justice Can’t Wait: Human Rights Developments in Libya Amid Institutional Obstacles*, December 12, 2009, <http://www.hrw.org/sites/default/files/reports/libya1209web.pdf>, p. 63-65.

<sup>397</sup> “Libya/US: Investigate Death of Former CIA Prisoner,” Human Rights Watch news release, May 11, 2009.

<sup>398</sup> Reporting on the exact arrest date varies. Some accounts say he was arrested on November 11, 2001. See Dana Priest, “Al Qaeda-Iraq Link Recanted: Captured Libyan Reverses Previous Statement to CIA, Officials Say,” *Washington Post*, August 1, 2004, <http://www.washingtonpost.com/wp-dyn/articles/A30909-2004Jul31.html> (accessed May 30, 2012); Others indicate it was “toward the end of November 2001.” Soufan, *The Black Banners*, p.450; Others say he was captured on December 19, 2001 by Pakistani security. Mayer, *The Dark Side*, p. 103-04 and Isikoff and Corn, *Hubris*, p. 119.

<sup>399</sup> Human Rights Watch interview with Safrani, Bengazi, Libya, March 20, 2012.

<sup>400</sup> Ibid.

<sup>401</sup> Ibid.

held until December 2006, when the United States forcibly transferred him back to Libya (see above).<sup>402</sup>

According to al-Libi's family, after Kandahar, the United States took him to Kabul (more likely Bagram Air Base)<sup>403</sup> and then transferred him to Egypt.<sup>404</sup> Al-Libi's family said he was in Egypt for 13 months.<sup>405</sup> He told his family and other detainees with whom he was detained that he was sent to Egypt "in a coffin."<sup>406</sup> During his time in Egypt, he told others that his Egyptian captors beat and abused him constantly. He showed one fellow prisoner marks he said were from a drill that was used on him in Egypt and burns on his body that he received there.<sup>407</sup> He told another fellow prisoner at the time that he was cut with blades on his skin while there and that he was hung out an open window with no clothes on.<sup>408</sup> His Egyptian captors also had him lie on his stomach and forced his legs back towards his shoulder blades.<sup>409</sup>

After Egypt, al-Libi was apparently brought back to US custody, possibly to a CIA prison at Bagram.<sup>410</sup> This is where it seems he recanted the information he had provided earlier on

---

<sup>402</sup> Ibid.

<sup>403</sup> Mayer, *The Dark Side*, p. 104; Isikoff and Corn, *Hubris*, p. 120.

<sup>404</sup> Some prisoners held with al-Libi said that al-Libi told them he was actually given a choice of either Egypt or Israel and that he chose Egypt, a choice he said was a bad one. Human Rights Watch interview with Shoroeyiya, Tripoli, March 18, 2012; Human Rights Watch telephone interview with Bousidra, April 2, 2012. Bousidra was detained with al-Libi in the foreign intelligence building in Libya, Bousidra in cell three and al-Libi in cell seven; other prisoners described something similar. Sheikh Othman Salah said al-Libi told him that they said "if you don't talk in 24-48 hours and tell us your plan, you will be transferred to one of two countries that will have no mercy on you—Egypt or Israel." Human Rights Watch interview with Sheikh Othman Salah, Tripoli, Libya, January 12, 2012. Al-Libi told Abdullah Mohammed Omar al-Tawaty when they were detained together in a place called Asouk (he in cell three and Tawaty in cell 14) that when he was in the "dark prison" in Afghanistan, someone representing himself from the White House came into his cell and said that if he did not tell him in the next 20 minutes the operations that al Qaeda was planning against the US he would be taken to either Egypt or Israel. Human Rights Watch interview with Abdulla Mohammed Omar al-Tawaty, Benghazi, Libya, March 21, 2012.

<sup>405</sup> Human Rights Watch interview with Faraj el-Fakhri, March 21, 2012.

<sup>406</sup> Human Rights Watch telephone interview with Bousidra, April 2, 2012; Human Rights Watch interviews with Sheikh Othman Salah, January 12, 2012; Tawaty, March 21, 2012; Faraj el-Fakhri, March 21, 2012; Abdul Aziz el-Fakhri, March 22, 2012; and Shoroeyiya, March 18, 2012.

<sup>407</sup> Human Rights Watch interview with Shoroeyiya, March 18, 2012. Shoroeyiya said al-Libi showed him these marks when they were detained in Abu Salim prison in Tripoli. All prisoners detained there said at some point during their detention in Abu Salim, Libyan authorities allowed prisoners to leave their cells for limited periods of time and mix with other prisoners in certain sections of the prison, though they still had to be confined to certain locations.

<sup>408</sup> Human Rights Watch telephone interview with Bousidra, March 29, 2012.

<sup>409</sup> Ibid.

<sup>410</sup> Both Shoroeyiya and Sharif report talking to him during their time in US detention in Afghanistan, although when is not clear, from around April 18, 2003 to between April 20 and 25, 2004. This was likely the same place where al-Libi described being detained to al-Tawaty while they were in prison together in Asouk in Libya. Al-Libi told Tawaty that he was taken to the

links between Iraq and al Qaeda. On February 4 and 5, 2004, CIA officers sent cables to headquarters acknowledging that al-Libi's account from 2002 was not reliable.<sup>411</sup>

Reports vary as to where al-Libi was detained after his return to US custody following his time in Egypt. His brother and nephew in Libya said they mapped out his trajectory using a combination of information they got from him during family visits they had with him while he was detained in Libya as well as information from others with whom he was detained. They believe al-Libi was subsequently taken to a prison in the Panjshir Valley north of Kabul from June 2003 to October 2003, then Kabul again, Morocco for about a year, Guantanamo for three to five months, Alaska,<sup>412</sup> a US air base in Sweden,<sup>413</sup> and finally to Libya. Prisoners who were held with al-Libi told Human Rights Watch that he told them he was detained at each of these locations,<sup>414</sup> except some do not include Guantanamo or Sweden<sup>415</sup> and others add additional places, like Syria,<sup>416</sup> a warship,<sup>417</sup> and Poland or a European country for which they could not remember the name.<sup>418</sup> The amounts of time they say al-Libi spent in these locations vary, and they are less certain about this information. Human Rights Watch could not independently confirm this information.

---

"darkness prison" in Kabul, then Egypt, then to Bagram. He described the "darkness prison" as being so dark he could not see anything. He had only a bucket to use as a toilet and there was loud music playing all the time. These conditions are very similar to what Shoroieya and Sharif describe (see above) and both reported talking to Sheikh al-Libi during their time in detention at this location. Human Rights Watch interview with Abdullah Mohammed Omar al-Tawaty, March 21, 2012.

<sup>411</sup> SSCI Sept. 8, 2006 Report, p 79-83; See also Mayer, *The Dark Side*, p. 138; and Michael Isikoff, "The Missing Terrorist," *The Daily Beast*, May 27, 2007, <http://www.thedailybeast.com/newsweek/2007/05/27/the-missing-terrorist.html> (accessed May 25, 2012).

<sup>412</sup> Some speculate that al-Libi was told he was in Alaska but that he was actually in a secret CIA site in Poland, another cold location. See Larry Siems, *The Torture Report* (New York and London: OR Books, 2011), p. 401. Either way, he told a lot of other prisoners, including Bousidra, Tawaty, Othman, Shoroieya, and his family that he was in Alaska (he apparently told his mother that he was in a prison in North America that was an "icy desert").

<sup>413</sup> There have been allegations of forced repatriations from Sweden at the request of the CIA; See *Agiza v. Sweden*, Communication No. 233/2003, U.N. Doc. CAT/C/34/D/233/2003 (2005), <http://www1.umn.edu/humanrts/cat/decisions/233-2003.html> (accessed August 29, 2012). However, Human Rights Watch could not confirm any information about the US facility in Sweden to which al-Libi's relatives believe he was taken.

<sup>414</sup> Mohammed Bousidra, Abdullah Tawaty, Shoroieya, and Othman Salah all said al-Libi told them he was detained in these locations.

<sup>415</sup> Neither Shoroieya nor Abdullah Tawaty mention Guantanamo or Sweden. Othman Salah mentioned Guantanamo but did not mention Sweden.

<sup>416</sup> Mohammed Bousidra also said al-Libi told him he was held in Syria but was not sure if it was before or after Egypt. He said al-Libi told him he was stripped naked there and handcuffed from behind and hung up by his hands from behind.

<sup>417</sup> Mohammed Bousidra said al-Libi told him he was held on a warship.

<sup>418</sup> Shoroieya said al-Libi told him he was detained in Poland. Abdullah Tawaty and Bousidra both said al-Libi told them he was detained in a European country, but they did not remember which one.



It is not clear when Ibn al-Sheikh al-Libi was returned to Libya, but the first time his family was informed that he was there was in December 2007.<sup>419</sup> He was first detained in Tajoura prison and was then moved to Abu Salim, where he remained until he died.<sup>420</sup> At some point after being transferred, al-Libi had been sentenced to life in prison.<sup>421</sup> The last time his brother saw him was in March 2009, 40 days before he died.<sup>422</sup> It was the fourth time he had been able to visit him in prison. Several other family members had been able to visit as well.<sup>423</sup>

In his final weeks at Abu Salim, al-Libi was held in a separate wing of the facility. Some said he was placed there by the prison administration and others said he had requested the isolation.<sup>424</sup> The section had about 20 cells in one corridor, with 10 cells on each side. The corridor began with an open entrance from a courtyard and ended with a big metal door. Al-Libi was in one of the first two cells near the entrance by the courtyard.

All of the cells were empty except Libi's. Two prisoners, Hazem al-Ajdal and Mohammed al-Kaib, were the prisoners closest to him physically. They were being detained on the other side of the big metal door, which they said was always closed. Occasionally, though, they would see al-Libi in a place known as "the Area," where prisoners were sometimes taken for exposure to the sun.<sup>425</sup> Al-Ajdal said he was being detained in this section of the prison because he had an operation on the cornea of his eye and needed to share a cell with someone who could help him. His cellmate, al-Kaib, had hepatitis, as reportedly did al-Libi.<sup>426</sup> Both got extra exposure to the sun because of this. Whenever they saw al-Libi they said he was always alone; the only person near him was a guard.<sup>427</sup>

---

<sup>419</sup> Human Rights Watch interview with Abdul Aziz el-Fakhri, March 22, 2012. This also corresponds to the time that the Bush administration began closing down secret CIA detention sites and transferring detainees to either home or third countries.

<sup>420</sup> Human Rights Watch Interview with Faraj el-Fakhri, March 21, 2012.

<sup>421</sup> Ibid. See also "Libya/US: Investigate Death of Former CIA Prisoner," Human Rights Watch news release, May 11, 2009.

<sup>422</sup> Human Rights Watch interview with Abdul Aziz el-Fakhri, March 22, 2012.

<sup>423</sup> Ibid.

<sup>424</sup> The two who said he had asked to go there himself, Abdulla Mohammed Omar al-Tawaty and Hazem al-Ajdal, said he did so because he saw that he was attracting trouble to other prisoners who were seen with or talking to him, so he asked for the isolation to protect them. Human Rights Watch interview with Abdulla Mohammed Omar al-Tawaty, March 21, 2012; and Human Rights Watch telephone interview with Hazem al-Ajdal, March 27, 2012.

<sup>425</sup> "The Area" was a large walled space with a mesh roof that allowed sunlight in. Human Rights Watch telephone interview with Ajdal, Tripoli, Libya, March 27, 2012.

<sup>426</sup> Both Hazem al-Ajdal and Mohamed Bousidra said Sheikh al-Libi had hepatitis.

<sup>427</sup> Human Rights Watch telephone interview with Ajdal, March 27, 2012.



Wing of Abu Salim prison where Ibn al-Sheikh al-Libi was detained, photographed on March 28, 2012. Ibn al-Sheikh al-Libi's cell was the first one on the left. A large metal door at the end of the hall separated al-Libi from all other prisoners at Abu Salim.



Wing of Abu Salim prison where Ibn al-Sheikh al-Libi was detained, photographed on March 28, 2012. Ibn al-Sheikh al-Libi's cell was the first one on the left. A large metal door at the end of the hall separated al-Libi from all other prisoners at Abu Salim. *Right:* The entrance to the cell of Ibn al-Sheikh al-Libi at Abu Salim prison.



Inside the cell of Ibn al-Sheikh al-Libi at Abu Salim prison, photographed on March 28, 2012. He died in this cell on May 9, 2009. Libyan authorities claim he committed suicide by hanging himself with a sheet, tied into a loop and hooked onto the corner of the edge of the wall in the middle of his cell.  
© 2012 Human Rights Watch

Those with whom Human Rights Watch spoke who knew al-Libi said he was very religious and cited this as the main reason why they were surprised by—and disbelieved—the government's claim that he had committed suicide. Suicide is strictly prohibited in Islam.<sup>428</sup> Shoroeiya told Human Rights Watch,

Nobody believed it was suicide. First of all, [al-Libi] was a very religious man and it is forbidden in our religion to commit suicide, and second of all, it makes no sense that after all that he had faced he would then commit suicide. As bad as it was in Libya, it was better than any place he had been.<sup>429</sup>

<sup>428</sup> Wright, *The Looming Tower*, p. 248. Some Islamist militants who believe in the use of suicide bombings do not believe it is suicide, but martyrdom, and thus permissible; Soufan, *Black Banners*, p. 92, 94, 187.

<sup>429</sup> Human Rights Watch interview with Shoroeiya, March 18, 2012.

Mostafa al-Mehdi (see above) saw al-Libi two weeks before he died. During Human Rights Watch's 2009 visit, the Libyan authorities had gathered all the prisoners that we had requested to see together at the clinic inside the prison. Mehdi said Abu Salim prison authorities had fixed the clinic up: "They cleaned it up and put doctors inside and an ambulance out front." The authorities suggested to the prisoners during this meeting that they all tell Human Rights Watch that they did not want to cooperate with us.<sup>430</sup> Mehdi said during this meeting, al-Libi "did not seem himself" and "had completely changed.... He was in very bad condition—both mentally and physically.... It was so obviously clear.... He couldn't talk clearly and was so thin. You could recognize he was not well because, I knew this guy. His character was so friendly—he used to welcome everybody and make them laugh. We had known each other for years, since our time in Peshawar together, but he acted like we never met or knew each other."<sup>431</sup>

At the time of al-Libi's death, human rights groups called on the Gaddafi government to open a full investigation.<sup>432</sup> Since the fall of Gaddafi, al-Libi's brother and uncle have renewed this request with the new government.<sup>433</sup> Al-Libi's family showed Human Rights Watch pictures taken of al-Libi date-stamped the morning of his death. They said they got the pictures from the prosecutor's office conducting the inquiry.<sup>434</sup> The photos depict al-Libi in the position in which guards allegedly found him in his cell on the morning of his death.

In the first picture, al-Libi's back is up against a gray brick wall that separated his cell in two sections. The wall was about seven and a half feet high and about six inches thick. His back is up against the six inch edge of the wall. A sheet with ends tied together is looped around the top part of the thin section of the wall and his head rests in the loop created. His feet are firmly on the ground and his legs slightly bent at the knee.

---

<sup>430</sup> Human Rights Watch Interview with Mehdi, Tripoli, Libya, March 14, 2012.

<sup>431</sup> Human Rights Watch Interview with Mehdi, March 14, 2012.

<sup>432</sup> "Libya/US: Investigate Death of Former CIA Prisoner," Human Rights Watch news release, May 11, 2009; See also "Document—Libya: Amnesty International Completes First Fact Finding Visit in Over Five years," Amnesty International public statement, May 29, 2009, <http://www.amnesty.org/en/library/asset/MDE19/003/2009/en/d226b133-691d-41dc-aabf-ca89038618e7/mde190032009eng.html> (accessed August 29, 2012).

<sup>433</sup> Human Rights Watch interviews with Faraj el-Fakhri, March 21, 2012; Abdul Aziz el-Fakhri, March 22, 2012; and other prisoners who were detained with al-Libi while in Libya and Afghanistan.

<sup>434</sup> Human Rights Watch interviews with Faraj el-Fakhri, March 21, 2012; and Abdul Aziz el-Fakhri, March 22, 2012.

The next picture is taken from above him. He is lying on the ground, his arms are at his side. On the inside of his left arm is a large bruise that takes up a large portion of his arm. It is dark, black and blue. His feet are very red and look swollen.

Another picture shows him lying on his stomach, so his back is visible. He is shirtless. There are two long light scratches that go at an angle across his back from the middle of his shoulder blades to the middle of his lower back. There is also a spot, about a centimeter in diameter, that looks like a small bruise on the top of his back near his shoulder blades. At the time of this writing, the family was looking into having the photos analyzed by a forensic specialist. The family informed us that an autopsy was done at the time of his death and the report is with the prosecutor.

## VI. Detainees Rendered From Other African Countries to Libya

HRW interviewed seven Libyans with an Africa connection. In addition to Di'iki and Madaghi, who were both initially picked up in Mauritania, and Abu Farsan (see above), sent by the Netherlands to Sudan, Human Rights Watch interviewed four other former LIFG members who were picked up in Africa and forcibly returned directly to Libya. In these cases, there were fewer allegations of Western government involvement in their renditions to Libya, although three of the four allege they were interrogated by American and other Western agents prior to their return.<sup>435</sup> After a period of detention in Libya—in two cases the detention was accompanied by physical abuse at the hands of the Libyans—three of the four were summarily tried and convicted for their involvement with the LIFG and sentenced to life in prison.

### Ismail Omar Gebril al-Lwatty

*Human Rights Watch interviewed Osmail Omar Gebril al-Lwatty (Lwatty) in Tripoli in March 2012. The following account and quotes are drawn from this interview unless otherwise noted.*<sup>436</sup>

Lwatty is from Benghazi and was 22 when he left Libya in February 1990. He had been working as a technician in the post office. In 1989 the Libyan government detained him for five days for what he said were false allegations of being involved with an opposition group. “I was definitely dissatisfied with Gaddafi, but I wasn’t in any kind of organized group against him,” he said. “I was afraid because the detentions were so random and widespread and they were executing people.... I felt as though I had to leave the country.”

Lwatty first went to Saudi Arabia, then Afghanistan, where he was part of the LIFG and fought with Afghan rebels against the Soviet-installed government. In 1993 he moved with

---

<sup>435</sup> We obtained the names of several other Libyans who were forcibly sent back to Libya from countries in Africa, allegedly with US involvement. Due to time constraints, we were unable to interview them during our research visit to Libya.

<sup>436</sup> Human Rights Watch interview with Lwatty, Tripoli, Libya, March 17, 2012.

the LIFG to Sudan, where he lived for the next nine years. In Sudan he got married and, with the LIFG, took part in a number of failed operations against Gaddafi.

On September 12, 2002, the Sudanese arrested him and found him in possession of a number of weapons that he said were for use in operations against Gaddafi when the Libyan leader traveled to Sudan. He said that while in custody, he was interrogated on two separate days by individuals who identified themselves as American. One was a white, heavysset man, about 45 years old, with partially balding salt-and-pepper hair and green eyes. He described another as having light brown hair and a medium build, and being about 30 years old. They had a Lebanese interpreter with them. One interrogation began around 1 p.m. and went until 8 or 9 p.m. The second interrogation ran from midnight to 3 a.m. They wanted to know whether he had any information about al Qaeda targeting US interests, why he was in possession of the weapons, and whether he had any connections to the US embassy bombings in Tanzania and Kenya in 1998. Lwatty believes he was able to make the US agents understand he was only interested in Gaddafi.

About a month after his arrest, on October 17, 2002, he was transferred back to Libya. “This is when the nightmares began. I knew I was never going to see life again,” he told Human Rights Watch. He asked the Sudanese Foreign Ministry official who informed him of his transfer why he was being returned. He said he told the official, “You know what is going to happen to me there.” The official responded, “I have no control over it. There is an agreement between Gaddafi, Sudan, and the US.”

He was sent back to Libya on a flight with his family, including his six-year-old daughter, and was immediately separated from them on arrival. He did not see or hear from them for another two years. He was successively held in Tajoura prison for about 45 days, a prison he referred to as “internal security on Sikka road” for about three and a half months, Ain Zara prison for about two years, and Abu Salim prison until his ultimate release on February 16, 2011.<sup>437</sup> After about two years in detention, he said he was charged with, among other things, joining an illegal organization—the LIFG—and fighting against a friendly government—Russia. He was initially charged jointly with about 20 other people. He was

---

<sup>437</sup> Due to limits on time we were not able to find out about Lwatty’s treatment in Libyan detention other than one incident. While detained at Abu Salim, he was given permission to speak to visiting representatives of Amnesty International. But before the interview, he was kept in a very small container with tiny vents for several hours that did not allow in enough air. The authorities told him that if he said anything negative to Amnesty International, he would suffer consequences. After the interview with Amnesty, he was put back into the container for another five hours.

appointed a lawyer who he said did little more in court than “rattle off the names of all the people he represented.” Lwatty denied all the charges against him. He was convicted and sentenced to life in prison, which was later reduced to twelve years.



Mafud Embaya Abdullah.  
© 2012 Human Rights Watch

## Mafud al-Sadiq Embaya Abdullah

*Human Rights Watch interviewed Mafud al-Sadiq Embaya Abdullah (Embaya) in Benghazi in March 2012. The following account and quotes are drawn from this interview unless otherwise noted.<sup>438</sup>*

Embaya was 26 when he left Libya in 1996. He is the eldest of six siblings and had been studying at the University of Benghazi. He said he left the country after some of his neighbors were arrested. “They were committed to religion, they were afraid, I was afraid,” he said. “We knew that if someone was arrested they weren’t getting out.

They were being detained for a long time.” He had also heard that people were being beaten until they gave up the names of other people who would then be arrested as well.

Embaya initially went to Chad, then to Sudan, where he was involved in trade. He said he only joined the LIFG in 2000. After that he went to Afghanistan, where he stayed until late 2001. He then began moving around constantly, trying to avoid arrest. He was in Iran for six months, Sudan, Nigeria twice, and finally back to Chad. He said he was tracked down after the Chadian authorities said they found his name and contact number on the computer of another LIFG member who had been detained.

He was arrested on November 25, 2004 in Chad’s capital, N’Djamena, and held until March 17, 2005. During this time he was held in a cell that had a stone floor with no mattress or blanket. His hands were handcuffed and his feet shackled day and night. He was only

---

<sup>438</sup> Human Rights Watch interview with Mafud al-Sadiq Embaya Abdullah, Benghazi, Libya, March 2012.

released to go to the bathroom. He was not beaten but was provided insufficient food and lost considerable weight.

While detained, several individuals who told him they were American interrogated him for a total of about 30 days. The first time was a week after he had been arrested and the last time was two days before he was sent back to Libya. Of the first two interrogators, one was an older man who could speak broken Arabic. He was a white man with gray hair. The other interrogator had darker skin and reddish-toned hair. Later a female interrogator with an interpreter came to ask questions; she had pictures of LIFG members in Sudan for him to identify. He said the interrogators both told him they were American, and from where he was detained he could see cars as they arrived to the facility. The car they arrived in had diplomatic plates that Embaya said indicated they were from the US Embassy. He said he was also interrogated separately by French intelligence. They spoke French, had an interpreter from the Chadian security office, and identified themselves as being part of French intelligence. Embaya said their car had plates indicating they were from the French embassy.

Embaya said the Americans asked him all sorts of questions about Osama bin Laden and al Qaeda. They wanted to know, among other things, where bin Laden was, if he had nuclear weapons, and what sort of attacks he was planning. He said the Americans offered him a deal: they would pay him money and not send him back to Libya if he agreed to collect information for them. He said he did not trust them so did not accept their offer but also tried not to refuse outright. Two days after his last interrogation with the Americans he was sent back to Libya. He said he expected that.

He arrived on March 17, 2005. At first he was taken to Musa Kusa's offices in external intelligence, then to the al Nasser bureau, then Ain Zara prison, and finally to Abu Salim prison, where he was detained until his release on February 16, 2011. While in Libyan custody, his captors slapped and kicked him on numerous occasions and threatened to tear out his fingernails and let dogs attack him. From August 28, 2008 until his release, he was kept in solitary confinement in small cell, about 1 x 2 meters with just a bucket for a toilet. They forced him to shave his beard against his religious beliefs. When he and the other prisoners protested their conditions, they would receive abusive treatment, sometimes beatings and other times just verbal insults.



In early 2008 he was charged with being a member of the LIFG and participating in the war in Afghanistan against the government. He was taken to court once, when they read all the charges against him and appointed a lawyer. Others were also charged that day. He never returned to court but a few months later was informed that he had been convicted and received a life sentence. “I thought I was going to spend the rest of my life in jail,” he said.



Abdullah Omar al-Tawaty  
© 2012 Human Rights Watch

## Abdullah Mohammed Omar al-Tawaty

*Human Rights Watch interviewed Abdullah Mohammed Omar al-Tawaty (Tawaty) in Benghazi in March 2012. The following account and quotes are drawn from this interview unless otherwise noted.<sup>439</sup>*

Abdullah Mohammed Omar al-Tawaty<sup>440</sup> is from the town of Ajdabiya, in eastern Libya. He left Libya in 1996 at the age of 23. He was studying political science at the time at a university in Benghazi. He told Human Rights Watch he left the country because at the time he was involved in groups opposed to Gaddafi and as a result, many of his friends and colleagues had been arrested. Many were killed in the Abu Salim prison massacre of 1996. Police ransacked his cousin’s home looking for him, so he decided to leave, fearing arrest and mistreatment.

Tawaty went to a number of countries with the help of the LIFG, including Egypt, Morocco, Sudan, Mauritania, and Mali. In 2000 he got married and stayed in Mauritania. On November 14, 2004, the internet café that he was using was raided and he was arrested. The Mauritanian authorities detained him for about seven weeks. Three days after his arrest, they took him to a villa that was under intensive guard, where he was interrogated daily for about two-and-a-half weeks straight. Those who interrogated him represented themselves as being from “Interpol.” One man identified himself as Robert from South Africa and another said he was Diego from Spain. They spoke Arabic with a Palestinian accent.

---

<sup>439</sup> Human Rights Watch interview with Abdullah Mohammed Omar al-Tawaty, Benghazi, Libya, March 21, 2012.

<sup>440</sup> Tawaty also went by the name of Abdul Rahman.

Tawaty said that for the first six days he was handcuffed to a very uncomfortable chair and prevented from sleeping. He asked for a lawyer and to speak to his family, but these requests were refused. He was not physically abused except once when a Mauritanian officer slapped him across the face.

His interrogators wanted to know about the LIFG and other groups in Afghanistan, with whom they were associated, who he knew, what LIFG members were in other countries, and what sorts of operations they were planning. He told them that he was part of a group opposed to Gaddafi but that he was not involved in any military actions. He admitted that others in the group were but that he was not involved in that part of the organization. They gave him a polygraph test to see if he was telling the truth. After his questioning ended, he was taken back to the Mauritanian intelligence department.

Tawaty said he then escaped from detention. He told Human Rights Watch that the Mauritanian authorities did not have sophisticated security and it was not difficult to find a way to break out. Tawaty fled Mauritania for neighboring Mali and managed to elude arrest until May 14 or 15, 2006, when the authorities arrested him along with Sheik Othman (see below). They knew who he was and the name he went by—Abdul Rahman. Three days later he was sent back to Libya. He did not know where he was going until they arrived at the airplane.

He was initially detained in Tajoura, then subsequently at the internal security department on Sikka Road, Ain Zara, and finally Abu Salim, where he was held from December 13, 2007 until February 16, 2011.

## Othman Salah (Sheikh Othman)

*Human Rights Watch interviewed Othman Salah (Sheikh Othman) in Tripoli in March 2012. The following account and quotes are drawn from this interview unless otherwise noted.<sup>441</sup>*

Sheikh Othman left Libya in February 1990 “due to the abuses of the Gaddafi regime,” he said. Prior to this he worked for a manufacturing association. He initially went to Saudi Arabia, Pakistan, and then Afghanistan, where he fought against the Soviet-installed

---

<sup>441</sup> Human Rights Watch Interview with Othman Salah, Tripoli, Libya, March 15, 2012.

government. After 1992, when the government fell, he moved to Africa, first to Mauritania, where he lived for about two years, then to Sudan where he lived for about a year-and-a-half, and then back to Mauritania for another four years. He moved around between these places because the Libyan government was looking for him, arresting some of his colleagues with the help of the Mauritanian and Sudanese governments and then sending them back to Libya. Then in October 2002, he went to Saudi Arabia, where he stayed until January 2005.

Sheikh Othman said his main role within the LIFG while in Saudi Arabia was to help other LIFG members get documentation and passports, since they could not get passports issued by the Libyan government. He left Saudi Arabia when he suspected he would soon be arrested by Saudi authorities because of these activities. But after Saudi Arabia, he said, “there was nowhere to go.” He went to Mali. After about three months, the authorities arrested him on March 14 or 15, 2006, along with another LIFG member, Abullah Mohammed Omar al Tawaty, and a Mauritanian man.<sup>442</sup>

He believes that monitoring of his communications by foreign governments had contributed to his arrest. Earlier his wife and family had flown from Saudi Arabia to Mauritania. He had called his wife twice before she left Saudi Arabia to help her arrange transportation. After she arrived in Mauritania, she made it through airport checkpoints, but about 100 kilometers on the road out of the airport she was stopped, detained, and questioned. From her they learned about his being in Mali. Shortly thereafter he was arrested.

Sheik Othman was brought to the Mali intelligence headquarters and placed in a cell by himself. Within 10 minutes, a black 4 x 4 vehicle drove into the complex and two white men, who he believed were American, got out. One was in military uniform and the other in civilian clothes. Sheikh Othman said he was then interrogated for five days. High-level Mali intelligence officers were asking the questions, but he said that others in a room next door clearly were composing them. The Mali intelligence agent constantly went to the room next door for clarification and more questions. Whoever was directing the questions knew everything about Sheik Othman’s time in Saudi Arabia, with whom he was associated, conversations he had had, and people he knew. He first denied being Libyan, but they

---

<sup>442</sup> These are the same dates that Tawaty was captured in Mali, but it is not clear if he was detained.

knew his name and much about him so he said it was useless to deny for very long. He was shown, for example, his residency photo from Saudi Arabia. Othman said he believed there was no cooperation between the Mali and Saudi governments at the time. Because of this—and because he believed neither Mauritania nor the Mali government had the capacity to monitor communications in the way they did, as evidenced by his wife’s detention after she arrived in Mauritania—he believes that the US, UK, or other Western governments with more sophisticated surveillance technology were involved in his arrest, detention, and interrogation, and ultimately his transfer back to Libya. He was sent back to Libya about five days after his arrest, around March 20, 2006.

Sheikh Othman told Human Rights Watch that when he realized he was being sent back to Libya he felt a sense of dread but also a sense of relief: “Of course it was not good that I was going back, I was going to be handed over, to surrender, but I had been living in the unknown for so long, at least I knew my direction, I was not lost anymore.” Also, he said, there was some relief in knowing he was not going to Guantanamo or Afghanistan, where he knew other LIFG members had been sent and treated badly. “I knew many other Libyans who had been taken to Morocco and Bagram. Although I was not happy to be going back to Libya, at least I knew I was not going to any of these other places.”

He was initially detained in Tajoura prison for 10 months, then a prison on Sikka Road for 20 days, then Ain Zara for eight months, and then Abu Salim prison for the duration of his detention, nearly four years.

While in Libyan custody, Sheikh Othman said, he was occasionally kicked and punched. The whole time he was in Tajoura, he was kept in a solitary cell and not allowed to see or talk to other prisoners. When he had a serious infection in his abdomen, he was denied medical treatment. And he did not have contact with his family for two years. Other than that, he said he was treated “relatively normally,” which he said “shocked me.” He credited Saif Gaddafi’s attempts at reform for this better treatment. Several years after he was sent back to Libya, he was charged with attempting to overthrow the government and for his role within the LIFG and sentenced to life in prison.

He was released on August 23, 2012, around the time Tripoli fell to rebel forces. He now works in the offices of the Tripoli Military Defense Council, where one of his responsibilities is compiling data on the number of returns of Libyans living abroad by foreign

governments during the Gaddafi government. Before Human Rights Watch's research mission to Tripoli in March 2012, Sheikh Othman provided Human Rights Watch with the names and contact information for 21 former prisoners who he said were returned to Libya during the Gaddafi era with US, UK, or other foreign government involvement. We were able to interview 13 of these individuals for this report. Of the remaining eight, one was no longer alive (Ibn al-Sheikh al-Libi); another, the only other Guantanamo detainee to be returned to Libya besides Abdusalam Abdulhadi Omar as-Safrani (Abu Sufian Ibrahim Ahmed Hamuda Bin Qumu), refused to speak with us; and six could not be reached. Thus we were unable to confirm or deny these other alleged transfers to Libya.

## VII. International Legal Standards

The treatment of the individuals interviewed in this report violated fundamental human rights under international law. These included the prohibitions against arbitrary arrest and detention; torture and cruel, inhuman, or degrading treatment; and enforced disappearance.<sup>443</sup> Those apprehended in the context of an armed conflict would also have been protected from torture and other ill-treatment under international humanitarian law, or the laws of war.

The subsequent rendition (transfer) of these individuals to Libya violated the prohibition against refoulement—forcible return to a country where they were in danger of being tortured, ill-treated, or persecuted. The principle of non-refoulement is grounded in both the prohibition against torture and international refugee law and is protected by both treaty and customary international law.<sup>444</sup>

The prohibition against torture, as well as cruel, inhuman, or degrading treatment or punishment (referred to as “ill-treatment”) is absolute.<sup>445</sup> No state, even in times of armed

---

<sup>443</sup> See Convention against Torture and Other Cruel, Inhuman or Degrading Treatment or Punishment (Convention against Torture), adopted December 10, 1984, G.A. res. 39/46, annex, 39 U.N. GAOR Supp. (No. 51) at 197, U.N. Doc. A/39/51 (1984), entered into force June 26, 1987; International Covenant on Civil and Political Rights (ICCPR), entered into force March 23, 1976, G.A. res. 2200A (XXI), 21 U.N. GAOR Supp. (No. 16) at 52, U.N. Doc. A/6316 (1966), 999 U.N.T.S. 171, arts. 7 & 9; Declaration on the Protection of All Persons from Enforced Disappearances, adopted by G.A. res. 47/133, December 18, 1992, 47 U.N. GAOR Supp. (No. 49) at 207, U.N. Doc. A/47/49 (1992).

<sup>444</sup> UN Human Rights Committee, “Issues Relating to Reservations Made upon Ratification or Accession to the Covenant or the Option Protocols thereto, or in Relation to Declarations under Article 41 of the Covenant,” General Comment 24, CCPR/C/21/Rev.1/Add.6 (1994), <http://www.unhcr.ch/tbs/doc.nsf/o/69c55b086f72957ec12563ed004ecf7a?Opendocument> (accessed June 27, 2012), para. 10 (explaining that certain human rights provisions that have become customary international law cannot be derogated from, including the right to be free from torture, arbitrary arrest and detention, and the right to a fair trial); See also Restatement (Third) of the Foreign Relations Law of the United States, sec. 702 (1987); Human Rights Watch, *Still at Risk: Diplomatic Assurances No Safeguard Against Torture*, Vol. 18, 17, no. 4(D), April 2005, <http://www.hrw.org/sites/default/files/reports/eca0405.pdf>, p. 12-13; and Sie Elihulauterpacht and Daniel Bethlehem, “2.1 The Scope and Content of the Principle of Non-Refoulement: Opinion,” *Refugee Protection in International Law*, (Erika Feller et al., eds., 2003), <http://www.unhcr.org/4a1ba1aa6.html> (accessed June 28, 2012), p. 143-44.

<sup>445</sup> The Convention against Torture defines torture as “any act by which severe pain or suffering, whether physical or mental, is intentionally inflicted on a person for such purposes as obtaining from him or a third person information or a confession, punishing him for an act he or a third person has committed or is suspected of having committed, or intimidating or coercing him or a third person” and when “inflicted by or at the instigation of or with the consent or acquiescence of a public official or other person acting in an official capacity.” Convention against Torture, art. 2.

conflict or emergency, may “opt out” of this obligation.<sup>446</sup> Specifically, under the Convention against Torture and other Cruel, Inhuman or Degrading Treatment or Punishment (Convention against Torture), a state violates the treaty not only when it directly inflicts torture upon a detainee, but also when it sends a person to a country where there are substantial grounds for believing that they may be subjected to torture.<sup>447</sup> The danger must be assessed for both the initial receiving state and for subsequent states to which the person may be expelled, returned, or extradited.<sup>448</sup> The assessment of the risk must take into account the existence of a consistent pattern of gross, flagrant or mass violations of human rights.<sup>449</sup> The individual must be given an opportunity to contest the expulsion before an effective, independent, and impartial body before he can be transferred.<sup>450</sup>

The International Covenant on Civil and Political Rights (ICCPR) also mandates that a state may not expose an individual to the danger of torture or ill-treatment by way of “extradition, expulsion or refoulement.”<sup>451</sup> Further—though not an absolute prohibition, as some

---

<sup>446</sup> Convention against Torture, art. 2(2); UN Committee Against Torture, General Comment 2, CAT/C/GC/2 (2008), <http://www.unhcr.org/refworld/publisher,CAT,GENERAL,,47ac78ce2,o.html> (accessed June 28, 2012), para. 5 (noting that language in article 2 of the convention stating that “no exceptional circumstances whatsoever may be invoked by a State Party to justify acts of torture,” means that the prohibition against torture is absolute and non-derogable).

<sup>447</sup> Convention against Torture, art. 3. Article 3 states in full:

1. No State Party shall expel, return (“refouler”) or extradite a person to another State where there are substantial grounds for believing that he would be in danger of being subjected to torture.
2. For the purpose of determining whether there are such grounds, the competent authorities shall take into account all relevant considerations including, where applicable, the existence in the State concerned of a consistent pattern of gross, flagrant or mass violations of human rights.

<sup>448</sup> UN Committee against Torture, “Implementation of article 3 of the Convention in the context of article 22,” General Comment No. 1, U.N. Doc. 11/21/1997.A/53/44, annex IX, CAT General Comment No. 1 (General Comments), [http://www.unhchr.ch/tbs/doc.nsf/\(Symbol\)/13719f169a8a4ff78025672b0050eba1?Opendocument](http://www.unhchr.ch/tbs/doc.nsf/(Symbol)/13719f169a8a4ff78025672b0050eba1?Opendocument) (accessed June 26, 2012), para. 2 (“The Committee is of the view that the phrase ‘another State’ in article 3 refers to the State to which the individual concerned is being expelled, returned or extradited, as well as to any state to which the author may subsequently be expelled, returned or extradited.”); See also UN Committee against Torture, *Korban v. Sweden*, U.N. Doc. CAT/C/21/D/088/1997 (November 16, 1988), para. 6.5, 7.

<sup>449</sup> Convention against Torture, article 3(2). See also UN Committee against Torture, *Tala v. Sweden*, Doc. CAT/C/17/D/43/1996 (March 7, 1996) para. 10.1.

<sup>450</sup> See UN Committee against Torture, *Agiza v. Sweden*, 233/2003 (May 20, 2005), para. 13.7-13.8 (“the absence of any avenue of judicial or independent administrative review of the Government’s decision to expel the complainant does not meet the procedural obligation for effective, independent and impartial review required by article 3 of the Convention”); See also UN Committee against Torture, *Arana v. France*, U.N. Doc. CAT/C/23/D/63/1997 (June 5, 2000), paras. 11.5, 12.

<sup>451</sup> UN Human Rights Committee, “Replaces General Comment 7 Concerning Prohibition of Torture and Cruel Treatment or Punishment (Art. 7),” General Comment No. 20, (1992), [http://www.unhchr.ch/tbs/doc.nsf/\(Symbol\)/6924291970754969c12563ed004c8ae5?Opendocument](http://www.unhchr.ch/tbs/doc.nsf/(Symbol)/6924291970754969c12563ed004c8ae5?Opendocument) (accessed June 27, 2012), para. 9. See also UN Human Rights Committee, “Nature of the General Legal Obligation Imposed on States Parties to the Covenant,” General Comment No. 31, CCPR/C/21/Rev.1/Add.13 (2004)

exceptions apply—the 1951 Convention relating to the Status of Refugees (1951 Refugee Convention) and its 1967 Protocol protect against refoulement to places where a refugee’s “life or freedom would be threatened on account of race, religion, nationality, social group, or political opinion.”<sup>452</sup> The Third Geneva Convention of 1949, applicable during international armed conflicts, requires that prisoners of war only be transferred to states that are parties to the Convention who appear willing and able to apply its protections. The Fourth Geneva Convention of 1949 provides similar protection for civilians.<sup>453</sup>

The United States and United Kingdom are both parties to the Convention against Torture and the ICCPR, as are Libya and Pakistan, also implicated in abuses against persons in custody.<sup>454</sup> Other countries that may have some role in unlawful renditions to Libya are the Netherlands, Chad, Mauritania, Mali, Morocco, Malaysia, and China.<sup>455</sup>

The United States violated its international legal obligations by detaining individuals without charge or trial for as long as two years, subjecting them to torture and other ill-treatment, depriving them of access to lawyers and family members, and then returning

---

<http://www.unhcr.ch/tbs/doc.nsf/o/58f5d4646e861359c1256ff600533f5f?Opendocument> (accessed June 27, 2012), para. 12 (The obligation is not to “extradite, deport, expel, or otherwise remove a person from their territory.”).

<sup>452</sup> Convention relating to the Status of Refugees (1951 Refugee Convention), 189 U.N.T.S. 150, entered into force April 22, 1954, art. 33; and Protocol relating to the Status of Refugees, 606 U.N.T.S. 267, entered into force October 4, 1967. Exceptions apply if there are reasonable grounds for regarding the person seeking protection as a “danger to the security of the country in which he is, or who, having been convicted by a final judgment of a particularly serious crime, constitutes a danger to the community of that country.” 1951 Refugee Convention, art. 33(2). However, even if any of the exceptions apply, a person is still protected by other treaties and customary international law prohibitions on returning someone to a place where they will face torture.

<sup>453</sup> Geneva Convention Relative to the Treatment of Prisoners of War (Third Geneva Convention), adopted August 12, 1949, 6 U.S.T. 3316, 75 U.N.T.S. 135, entered into force October 21, 1950, <http://www.icrc.org/ihl.nsf/FULL/375> (accessed June 28, 2012), art. 12; and Convention Relative to the Protection of Civilian Persons in Time of War (Fourth Geneva Convention), Geneva, adopted August 12, 1949, 6 U.S.T. 3516, 75 U.N.T.S. 287, entered into force October 21, 1950, <http://www.icrc.org/ihl.nsf/FULL/380?OpenDocument> (accessed July 2, 2012), art. 49. See also Article 3 common to all four Geneva Conventions of 1949, which applies to detained civilians and combatants in non-international armed conflicts and prohibits torture and “outrages against personal dignity, in particular cruel and degrading treatment.”

<sup>454</sup> The ICCPR has been ratified by 167 countries, including the US on June 8, 1992; the UK on May 20, 1976; Libya on May 15, 1970; and Pakistan on June 23, 2010. The Convention against Torture has been ratified by 151 countries, including the US on October 21, 1994; the UK on December 8, 1988; Libya on May 16, 1989; and Pakistan on June 23, 2010.

<sup>455</sup> The ICCPR was ratified by the Netherlands on December 11, 1978; Chad on June 9, 1995; Mauritania on November 17, 2004; Mali on July 16, 1974; Morocco on May 3, 1979; and signed by China on October 5, 1998 (applies to Hong Kong Special Administrative Region). The Convention against Torture was ratified by the Netherlands on December 21, 1988; Chad on June 9, 1995; Mauritania on November 17, 2004; Mali on February 26, 1999; Morocco on June 21, 1993; China on October 4, 1988, (applies to Hong Kong Special Administrative Region); The Refugee Convention was ratified by the Netherlands on May 3, 1956; Chad on August 19, 1981; Mauritania on May 5, 1987; Mali on February 2, 1973; Morocco on November 7, 1956; China on September 24, 1982; The Refugee Protocol was ratified by the Netherlands on November 29, 1968; Chad on August 19, 1981; Mauritania on May 5, 1987; Mali on February 2, 1973; Morocco on April 20, 1971; and China on September 24, 1982.



them to Libya in violation of their right to non-refoulement. Other countries also held detainees without charge or trial and subjected them to torture or ill-treatment. Governments had sufficient information to determine that LIFG members sent back to Libya faced torture—most suffered serious abuses and violations of their due process rights. The Netherlands gave Muhammad Abu Farsan an asylum hearing before deporting him to Sudan. However, an investigation into the role that intelligence from MI6 or the CIA may have played in the transfer, and whether Dutch authorities adequately assessed the risk of ultimate transfer to Libya, should be undertaken.<sup>456</sup>

A number of detainees in US and later Libyan custody faced long periods of solitary confinement. The UN Commission on Human Rights noted in an April 2003 resolution that “prolonged incommunicado detention may facilitate the perpetration of torture and can itself constitute a form of cruel, inhuman or degrading treatment or even torture.”<sup>457</sup> The UN Human Rights Committee stated that “prolonged solitary confinement of the detained or imprisoned person may amount to acts prohibited by article 7” of the ICCPR on torture and ill-treatment.<sup>458</sup> The UN special rapporteur on torture stated in an August 2011 report that “social isolation and sensory deprivation [in solitary confinement] that is imposed by some States does, in some circumstances, amount to cruel, inhuman and degrading treatment and even torture.”<sup>459</sup>

The United States in particular sought to get around the prohibition on rendition to torture through the use of “diplomatic assurances”—promises obtained from the receiving government that the transferee would not be ill-treated. Requests for these promises appear in some of the Tripoli Documents. One document from the CIA to Libya’s Musa Kusa shows the CIA trying to help the Libyans “assume control” of senior LIFG member Saadi in Hong Kong.

---

<sup>456</sup> See, for example, UN Committee against Torture, *Korban v. Sweden*, CAT/C/21/D/088/1997 (November 16, 1988), para. 6.5, 7 (The Committee ruled that Sweden had an obligation to refrain from forcibly returning the complainant to Jordan—even though it was never alleged he would face torture there—because he ran the risk, according to the evidence, of being expelled from that country to Iraq).

<sup>457</sup> UN Commission on Human Rights, “Torture and other cruel, inhuman or degrading treatment or punishment,” Resolution 2003/32, E/CN.4/2003/L.11/Add.4, para. 14.

<sup>458</sup> UN Human Rights Committee, “Replaces General Comment 7 Concerning Prohibition of Torture and Cruel Treatment or Punishment (Art. 7),” General Comment No. 20, Compilation of General Comments and General Recommendations Adopted by Human Rights Treaty Bodies, U.N. Doc. HRI/GEN/1/Rev.1 at 30 (1994), para. 6. Article 7 of the ICCPR states: “No one shall be subjected to torture or to cruel, inhuman or degrading treatment or punishment.”

<sup>459</sup> UN Human Rights Council, Interim report of the Special Rapporteur on torture and other cruel, inhuman or degrading treatment or punishment, Juan Mendez, A/66/268, August 5, 2011, para. 20.

Aware that Hong Kong was worried about “international concerns” over having a Libyan-registered aircraft land in Hong Kong, the CIA offered to pay for a third party charter flight for Saadi. “If payment of a charter aircraft is an issue, our service would be willing to assist financially to help underwrite those costs,” the document reads. It goes on to say, “Please be advised that if we pursue that option, we must have assurances ... that [Saadi] and his family will be treated humanely and that his human rights will be respected.”<sup>460</sup>

Though it is unclear if the United States ever received such assurances from Libya and, if so, in what form, diplomatic assurances are insufficient to protect against the risk of torture or ill-treatment.<sup>461</sup> The United Kingdom entered into a memorandum of understanding (MOU) with Libya in October 2005 in which Tripoli promised not to torture terrorism suspects sent from the UK. In 2007, however, British courts blocked returns of people to Libya under the MOU on the grounds that the suspects remained at real risk of being tortured if sent back to Libya, despite the MOU.<sup>462</sup>

One former CIA officer said that diplomatic assurances were made with the knowledge that they would be ignored. “Each time a decision to do a rendition was made, we reminded the lawyers and policy makers that Egypt was Egypt, and that Jimmy Stewart never starred in a movie called ‘Mr. Smith Goes to Cairo,’” said Michael Scheuer, a former CIA officer who claims to have initiated renditions to other countries during the Clinton administration. “[The lawyers] usually listened, nodded, and then inserted a legal nicety by insisting that

---

<sup>460</sup> Tripoli Document 2162.

<sup>461</sup> See, generally, Human Rights Watch, “*Empty Promises: Diplomatic Assurances No Safeguard against Torture*,” Vol. 16, No. 4(D), April 15, 2004, <http://www.hrw.org/reports/2004/04/14/empty-promises>; See also UN Commission on Human Rights, “Civil and Political Rights, Including the Questions of Torture and Detention,” UN Doc. E/CN.4/2006/6 (December 23, 2005), <http://www.unhcr.org/refworld/docid/441181ed6.html> (accessed July 2, 2012), p. 2 (stating that “Diplomatic assurances are not legally binding and ... are ineffective and unreliable in ensuring the protection of returned persons”).

See also cases rejecting the use of diplomatic assurances: UN Committee Against Torture, *Agiza v. Sweden*, 233/2003 (May 20, 2005) (Sweden’s procurement of diplomatic assurances from Egypt were not sufficient to protect the detainee against a manifest risk of torture upon return to Egypt. Assurances contained no mechanism for enforcement and the Swedish government provided no evidence it investigated the flagrant and consistent use of torture against detainees in Egypt); European Court of Human Rights (ECHR), *Saadi v. Italy*, 37201/06 (February 28, 2008); ECHR, *Khaydarov v. Russia*, 21055/09 (May 20, 2010); ECHR, *Klein v. Russia*, 24268/08 (April 1, 2010); UN Committee Against Torture, *Pelit v. Azerbaijan*, CAT/C/38/D/281/2005 (May 29, 2007); *Mahjoub v. Canada*, 2006 FC 1503 (December 14, 2006).

<sup>462</sup> UK Special Immigration Appeals Commission, *DD and AS v. The Secretary of State for the Home Department*, Appeal No. SC/42 and 50/2005 (April 27, 2007), [http://www.bailii.org/uk/cases/SIAC/2007/42\\_2005.pdf](http://www.bailii.org/uk/cases/SIAC/2007/42_2005.pdf) (accessed July 2, 2012); See also UN Committee Against Torture, *Korban v. Sweden*, CAT/C/21/D/088/1997 (November 16, 1988), para. 6.5, 7.

each country to which the agency delivered a detainee would have to pledge it would treat him according to the rules of its own legal system.”<sup>463</sup>

In the rare case in which diplomatic assurances have been found to satisfy obligations, they were much more robust than those the United States requested in the Tripoli Documents, including, among other things, post-return monitoring plans through ostensibly independent third parties.<sup>464</sup> But even these monitoring plans failed to adequately protect the individuals from the risk of torture in countries where the level of abuse is such that they would face a real risk of torture there.<sup>465</sup> Many forms of torture—such as sexual violence, prolonged solitary confinement, waterboarding and other mock executions, and sleep deprivation—leave no visible marks and can therefore be hidden. Detainees are also often afraid to report abuse to outside monitors for fear of reprisal.

Governments have an obligation under international law to investigate and prosecute those responsible for human rights violations and to provide redress for victims of abuse.<sup>466</sup> The Convention against Torture requires states to ensure that all acts of torture are criminalized under the state’s domestic law. The United States has done so in its federal anti-torture statute, the War Crimes Act, and through individual state criminal codes.<sup>467</sup> The Convention against Torture and the ICCPR obligate states to ensure that their domestic legal systems include an effective remedy for redress and an enforceable right to fair and adequate compensation, and that such remedies are enforced.<sup>468</sup>

---

<sup>463</sup> Michael Scheuer, “Exporting Detainees,” *International Herald Tribune*, March 12, 2005, <http://www.nytimes.com/2005/03/11/opinion/11iht-edscheuer.html> (accessed August 29, 2012). See also Human Rights Watch, *Double Jeopardy: CIA Renditions to Jordan*, April 8, 2008, <http://www.hrw.org/reports/2008/04/07/double-jeopardy-o>.

<sup>464</sup> See ECHR, *Othman v. United Kingdom*, 8139/09 (January 17, 2012), para. 194 (In which the court found that a Memorandum of Understanding (MOU) between the UK and Jordan amounts to a diplomatic assurance, provided sufficiently detailed and transparent promises from Jordan that the detainee would not be tortured upon return, in addition to a post-return monitoring mechanism that would enforce the promises. The court affirmed that the MOU is “superior in both its detail and its formality to any assurances which the Court has previously examined,” and addressed the protections that will specifically be afforded to the applicant upon arrival in Jordan).

<sup>465</sup> See, for example, *Lai Cheong Sing and Tsang Ming Na v. Canada (Minister of Citizenship and Immigration)*, 2007 FC 361 (April 5, 2007), para. 141 (“[P]ost-return mechanisms do little to mitigate the risk of torture and have proven ineffective in both safeguarding against torture and as a mechanism of accountability.”).

<sup>466</sup> The duty to investigate and prosecute those responsible for grave violations of human rights has its legal basis in the ICCPR (art. 2) and the Convention against Torture (arts. 4, 5, and 7).

<sup>467</sup> See Anti-Torture Statute, 18 U.S.C. sec. 2340A, <http://www.law.cornell.edu/uscode/text/18/2340A> (accessed July 2, 2012) (enacted pursuant to the US becoming a party to the Convention against Torture); War Crimes Act, 18 U.S.C. sec. 2441, <http://www.law.cornell.edu/uscode/text/18/2441> (accessed July 2, 2012).

<sup>468</sup> Convention against Torture, art. 14; ICCPR, art. 2(3).

However, despite overwhelming evidence that senior officials in the Bush administration were responsible for policies that led to torture and abuse against numerous individuals in US custody, there has been no criminal investigation into these alleged crimes.<sup>469</sup> Additionally, since the September 11 attacks, no federal court has granted a judicial remedy to victims of alleged US torture or rendition to torture.<sup>470</sup>

In the United Kingdom, more efforts have been undertaken to examine the government's role in torture and to compensate for abuse. The Tripoli Documents exposed MI6's role in the torture and rendition of two Libyans discussed in this report—Abdul Hakim Belhadj and Sami al-Saadi. The documents have, appropriately, led to a criminal inquiry.<sup>471</sup> Two earlier criminal investigations into alleged complicity in torture by MI5 and MI6 were concluded without anyone being charged.

In June 2010, British Prime Minister David Cameron announced a broader inquiry into policy failures that led to UK complicity in abuse, known as the “Gibson Inquiry” (after the retired judge who chaired it, Sir Peter Gibson). Human Rights Watch, which had called for such an inquiry, hoped that it would be capable of uncovering a full and accurate picture of UK involvement in overseas abuse. But when the terms of reference for the inquiry were published in July 2011, it became clear that the inquiry lacked the necessary independence and transparency to achieve this. As a result, Human Rights Watch and other nongovernmental organizations decided not to participate in the inquiry.<sup>472</sup>

The British government had always intended that the inquiry would only start work after the conclusion of any criminal cases. In January 2012, when the criminal investigations into the cases of Belhadj and Saadi were announced, the UK government stated it was

---

<sup>469</sup> See, generally, Human Rights Watch, *Getting Away with Torture: The Bush Administration and Mistreatment of Detainees*, July 11, 2011, <http://www.hrw.org/reports/2011/07/12/getting-away-torture-o> (accessed July 2, 2012).

<sup>470</sup> *Ibid.*

<sup>471</sup> “Joint Statement by the Director of Public Prosecutions and the Metropolitan Police Service,” Crown Prosecution Service news release.

<sup>472</sup> See Owen Bowcott, et al., “Gibson Inquiry into MI5 and MI6 Torture Collusion Claims Abandoned,” *The Guardian*, January 18, 2012, <http://www.guardian.co.uk/politics/2012/jan/18/gibson-inquiry-torture-collusion-abandoned> (accessed July 2, 2012); for more information on Human Rights Watch objections to the Gibson Inquiry, see Human Rights Watch, “Submission to the UK Foreign Affairs Select Committee,” May 24, 2012, <http://www.hrw.org/news/2012/05/24/hrw-submission-uk-foreign-affairs-select-committee>, para. 8 (Among other deficiencies, the Gibson Inquiry allowed evidence to be taken in secret, failed to provide meaningful ways to challenge evidence, and permitted the Cabinet Office rather than an independent judge to make disclosure decisions).

shelving the Gibson Inquiry and would hold a second judge-led inquiry at a later date once the Libya criminal cases were resolved.<sup>473</sup>

Regarding the right to redress, the United Kingdom settled the cases of fifteen former and one current Guantanamo detainees, who sued over UK complicity in their rendition and torture. The government initially fought the case but later settled, after a high court ruling that confidential documents would have to be released in the court proceedings.<sup>474</sup> The government admitted no liability along with the settlement.

The Belhadj and Saadi cases are also the subject of civil suits against former UK government officials and the UK government itself. But a draft law introduced by the government in May 2011, known as the Justice and Security bill, seeks to widen the use of secret hearings in civil courts when national security grounds are invoked. This would mean that applicants and their lawyers of choice would be excluded. Their interests would instead be represented by a security-cleared lawyer who is barred from communicating with the applicant about the secret evidence. Parliament is considering the bill at this writing.<sup>475</sup>

---

<sup>473</sup> Bowcott et al, "Gibson inquiry into MI5 and MI6 torture collusion claims abandoned," *Guardian*.

<sup>474</sup> Patrick Wintour, "Guantánamo Bay detainees to be paid compensation by UK government," *The Guardian*, November 15, 2010, <http://www.guardian.co.uk/world/2010/nov/16/guantanamo-bay-compensation-claim> (accessed June 30, 2012).

<sup>475</sup> Benjamin Ward, "Secret 'justice' is nothing of the sort," *New Statesmen*, June 16, 2012, <http://www.newstatesman.com/blogs/politics/2012/06/secret-justice-nothing-sort> (accessed July 25, 2012).

# Recommendations

## To the United States Government

- Consistent with obligations under the Convention against Torture, investigate credible allegations of torture and ill-treatment since September 11, 2001 and implement a system of compensation to ensure all victims can obtain redress.
- Acknowledge past abuses and provide a full accounting of every person that the CIA has held in its custody pursuant to its counterterrorism authority since 2001, including names, dates they left US custody, locations to which they were transferred, and their last known whereabouts.
- Ensure that any person subject to rendition abroad has the right, prior to transfer, to challenge its legality before an independent tribunal, including any diplomatic assurances made; to legal counsel; and to appeal a transfer before it is carried out.
- Prohibit reliance upon diplomatic assurances against torture and ill-treatment (and make public the procedures used to ensure compliance) if there is any credible evidence the person subject to transfer faces a risk of torture or other ill-treatment.
- Include in required periodic reports to the Committee against Torture, the Human Rights Committee, and other relevant international and regional monitoring bodies detailed information about all cases in which requests for diplomatic assurances against the risk of torture or other ill-treatment have been sought or secured in respect to a person subject to transfer.

## To the President of the United States

- Direct the attorney general to begin a criminal investigation into US government detention practices and interrogation methods since September 11, 2001, including the CIA detention program. The investigation should examine the role of US officials, no matter their position or rank, who participated in, authorized, ordered, or had command responsibility for torture or ill-treatment and other unlawful detention practices, including enforced disappearance and rendition to torture or other ill-treatment.
- Make publicly available the August 2009 report of the Special Task Force on Interrogation and Transfers (an inter-agency task force set up by the Obama administration in January 2009).

## To the US Congress

- Create an independent, nonpartisan commission to investigate the mistreatment of detainees in US custody anywhere in the world since September 11, 2001, including torture, enforced disappearance, and rendition to torture. Such a commission should hold hearings, have full subpoena power, compel the production of evidence, and be empowered to recommend the creation of a special prosecutor to investigate possible criminal offenses, if the attorney general has not commenced such an investigation.

## To the Government of the United Kingdom

- Set up a new, judge-led inquiry into the United Kingdom's involvement in detainee abuse and renditions to torture with full independence from the government and authority to allow it to establish the truth, including a presumption in favor of publication of information and evidence, with final decisions on such publication to be made by the inquiry. This inquiry should be set up immediately, without any requirement to wait for criminal investigations or warranted criminal prosecutions of UK officials.
- Where the United Kingdom is involved in the transfer of a person outside British territory and British control, condition continued UK involvement on guarantees that the person has the opportunity to challenge the lawfulness of the transfer in an independent court prior to the transfer, including on the grounds of torture or other ill-treatment.
- End efforts to pass the Security and Justice bill, which would widen the use of secret hearings whenever national security grounds are invoked in civil court proceedings, excluding the person affected and their lawyer from the courtroom and preventing disclosure of material showing UK involvement in wrongdoing by other countries.
- Provide a full accounting of the involvement of British security services in the detention or transfer of individuals to other countries without process since September 11, 2001, including the names of the victims, dates, level of involvement, locations to which they were transferred, and last known whereabouts.
- Publish without delay current and past guidance to the intelligence services on interrogation of suspects overseas.

- Legislate to revise the Criminal Justice Act 1988 and the Intelligence Act 1994 to clarify that superior orders or acting under “lawful authority” can never be a defense to complicity or participation in torture abroad.
- Revise or abolish section 135 of the Criminal Justice Act 1988, which permits the attorney general to prevent a prosecution on torture-related charges. In the meantime, the attorney general should announce that he will not intervene in any prosecution for crimes connected with torture, but will defer all decisions on prosecutions to the director of public prosecutions.

### **To the Government of Libya**

- Cooperate with parties conducting investigations into the rendition of individuals to Libya since 2001.
- Promptly investigate all allegations of torture and ill-treatment in detention facilities run by the state and armed groups in a thorough and impartial way.
- Hold accountable all those responsible for using torture or ill-treatment against persons in custody.
- Ensure that national laws provide safeguards against abuse by law enforcement officials during arrest and detention activities, as well as safeguards to ensure full due process rights.
- Ensure that confessions and other forms of evidence obtained by means of torture are not admissible in a court of law.
- Sign and ratify the Optional Protocol to the Convention against Torture and Other Cruel, Inhuman or Degrading Treatment or Punishment.

### **To the Government of Pakistan**

- Take all necessary measures to end the use of torture and other ill-treatment by Pakistani military intelligence agencies and civilian law enforcement agencies.
- Impartially investigate allegations of torture and other ill-treatment of terrorism suspects and, where sufficient evidence of wrongdoing exists, prosecute those responsible, regardless of position or rank.
- Ensure that all Pakistani military intelligence and law enforcement personnel at every level have received appropriate training in human rights law and its application in all cases, including with respect to terrorism suspects.



## **To the Government of the Netherlands**

- The Netherlands was the only government implicated in this report that does appear to have provided one of those profiled here with a hearing prior to sending him to another country. However it should still conduct an investigation into the transfer of Muhammad Abu Farsan from the Netherlands to Sudan, leading to his rendition to Libya. The investigation should determine whether authorities properly upheld their obligations to assess the risk of abuse or persecution of Abu Farsan, not only in the initial receiving state to which they sent him, but also in the subsequent states to which he might be—and in fact was—expelled, returned, or extradited.
- As a part of the investigation into the transfer of Muhammad Abu Farsan, examine and disclose publicly the role that intelligence from the CIA or MI6 may have played in the Dutch government’s decision to transfer him to a country that did not offer sufficient protection against onward transfer to Libya.

## **To the Governments of China, Hong Kong, Malaysia, and Thailand**

- Conduct an investigation into the transfers of Sami Mostefa al-Saadi and Abdul Hakim Belhadj to Libya, where there was clear risk of torture or ill-treatment upon return, and whether authorities properly upheld their obligations to protect individuals against these abuses.
- As a part of the investigation into the transfers of Saadi and Belhadj, examine and disclose publicly the role that intelligence from the CIA or MI6 may have played in each government’s decision not to prevent onward transfers to countries where they feared torture or other forms of persecution.

## **To the Governments of Chad, Mauritania, Mali, Morocco, and Sudan**

- Conduct an investigation into the transfers of Muhammed Abu Farsan, Ismail Omar Gebril al-Lwatty, Saleh Hadiyah Abu Abdullah Di’iki, Mustafa Salim Ali el-Madaghi, Mafud al-Sadiq Embaya Abdullah, Abdullah Mohammed Omar al-Tawaty, and Othman Salah to countries where they feared torture or other forms of persecution, and whether authorities properly upheld their obligations to protect individuals against return to torture or other ill-treatment.

- As a part of the investigation into the transfers of Abu Farsan, Lwatty, Di'iki, Madaghi, Abdullah, Tawaty, and Salah, examine and disclose publicly the role that intelligence from the CIA or MI6 may have played in each government's decision not to prevent transfers to Libya.

## Acknowledgments

This report was written by Laura Pitter, counterterrorism advisor at Human Rights Watch. It is based on research conducted in Tripoli primarily by Pitter but also by Sidney Kwiram, former emergencies consultant for Human Rights Watch, and further phone interview research from New York by Pitter and Hanan Salah, Libya and Mauritania researcher. It is also based on documents found by Peter Bouckaert, emergencies director, in Tripoli in August 2011, as well as independent research on unlawful rendition and secret detention by the United States and other governments over the past decade. Stacy Sullivan, consultant to Human Rights Watch, drafted early parts of the Background and Detention in Asia sections of the report. Mohammed al-Bahry, Wagde Bargig, and Basem Tulti facilitated interviews and provided translation for the report.

The report was substantively reviewed and edited by James Ross, legal and policy director, Alison Parker, US program director, Maria McFarland, US program deputy director, Andrea Prasow, senior counterterrorism counsel and advocate, and Joseph Saunders, program director. Fred Abrahams, special advisor to Human Rights Watch's program office, John Sifton, Asia advocacy director, Heba Morayef, researcher in the Middle East and North Africa division, Bill Frelick, director of Human Rights Watch's refugee program, Peter Bouckaert, emergencies director, and Tom Malinowski, Washington advocacy director, provided additional edits and substantive guidance.

Clive Baldwin, senior legal advisor for the legal and policy office, Ben Ward, deputy director for the Europe and Central Asia division, Ali Dayan Hasan, Pakistan director, Eric Goldstein, deputy director of the Middle East and North Africa division, and Corrine Dufka, senior researcher in the Africa division, provided specialist review. Dinah PoKempner, general counsel of Human Rights Watch, provided legal review. Sana Ahmed, Klatsky Fellow, provided additional research, as did interns Kimberly Colabro and Jason Tauches.

Adam Lewis, US program associate for terrorism and counterterrorism, provided production assistance, as did Elena Vanko and Samantha Reiser, both US program associates, Grace Choi, publications director, Enrique Piraces, senior online strategist, Anna Lopriore, photography specialist, Jessie Graham, senior multimedia producer, Amanda Baily,

multimedia specialist, Pierre Bairin, media director, and Fitzroy Hepkins, production manager.

Human Rights Watch is enormously grateful to the victims and families who shared their stories and who had the wherewithal to endure hours, sometimes days, of questioning by researchers for this report. We are also grateful to the many journalists, human rights reporters, and non-governmental organizations committed to reporting about these issues. We are particularly indebted to the American Civil Liberty Union for its freedom of information act litigation that has led to the declassification of many important documents revealing US abuses against individuals in the name of counterterrorism. We are also especially indebted to the New York University Center for Human Rights and Global Justice for putting together the 182-page declaration of Mohammed Farag Ahmad Bashmilah, and Amnesty International for documenting the case of Khaled al-Maqtari, both containing key corroborating information cited as evidence in this report.

MAY. 6. 1999 1:21AM  
MAY. 13. 1999 2:43AM

Secret

NO. 292 P. 1

## صفحة غطاء رسالة الفاكس

المعلومات المتضمنة في هذا الفاكس من نوع:  
The information contained in this fax transmission is considered:

URGENT عاجل جدا

IMMEDIATE عاجل

PRIORITY أولوية

ROUTINE عادي

Proposed Rendition of Tarabulsi الموضوع:  
Subject

15 April 2004 تاريخ وقت الارسال:  
Date/Time Transmitted

2 عدد الصفحات :  
Number of Pages

APR 15 1999 2:43PM

SECRET RELEASE LIBYA

15 April 2004

MEMO NUMBER: WT-04/00041  
SUBJECT: MUSTAFA SALIM ALI MODERI TARABULSI, AKA  
SHAYKH MUSA

YOUR SERVICE IS NO DOUBT AWARE OF TERRORIST SUSPECT AND LIFG MEMBER MUSTAFA SALIM ALI MODERI TARABULSI, AKA SHAYKH MUSA. MUSA WAS UNTIL RECENTLY, ACTING AS THE DEPUTY OF LIFG MEMBER 'ABD EL-SALAM EL-DIKI AKA SHAYKH ABU ABDALLAH AL-ZULAYTINI.

OUR SERVICE IS IN A POSITION TO DELIVER SHAYKH MUSA TO YOUR PHYSICAL CUSTODY, SIMILAR TO WHAT WE HAVE DONE WITH OTHER SENIOR LIFG MEMBERS IN THE RECENT PAST. WE RESPECTFULLY REQUEST AN EXPRESSION OF INTEREST FROM YOUR SERVICE REGARDING TAKING CUSTODY OF MUSA.

IN ADDITION, PER OUR RECENTLY DEVELOPED AGREEMENTS, WE REQUEST THAT YOUR SERVICE AGREE TO TAKE OUR REQUIREMENTS FOR DEBRIEFINGS OF MUSA, AS WELL AS A GUARANTEE THAT MUSA'S HUMAN RIGHTS WILL BE PROTECTED.

WE LOOK FORWARD TO YOUR COMMENTS.

SECRET RELEASE LIBYA

IMG\_2142.JPG

SECRET RELEASE LIBYA ONLY

4 April 2004

127/04-0028

SUBJECT: GUANTANAMO BAY

1. IN RESPONSE TO YOUR REQUEST TO INTERVIEW LIBYAN NATIONALS AT GUANTANAMO, WE OFFER THE FOLLOWING INFORMATION.

2. PLEASE SEND AN OFFICIAL DIPLOMATIC NOTE TO THE U.S. INTERESTS SECTION IN TRIPOLI, FROM YOUR FOREIGN MINISTRY, TO REQUEST TO VISIT DETAINEES AT GUANTANAMO BAY. PLEASE NOTE THAT WE DO NOT CONTROL WHICH SERVICES VISIT GUANTANAMO BAY AND /OR THE DATES APPROVED, THOUGH YOU MAY NOTE YOUR PREFERRED DATES.

3. PLEASE INCLUDE A COMPLETE LIST OF NAMES OF ANY DETAINEES WHO ARE TO BE INTERVIEWED WHO ARE NOT REPATRIATED NATIONALS OF YOUR COUNTRY. IT IS NOT NECESSARY TO PROVIDE ADVANCE INFORMATION ON NATIONALS OF YOUR COUNTRY. PLEASE ALSO PROVIDE COMPLETE VISITOR INFORMATION (FULL NAME; DATE AND PLACE OF BIRTH; PASSPORT NUMBER WITH ISSUE AND EXPIRATION DATES; ANY OTHER NAMES PREVIOUSLY USED).

4. THE U.S. DEPARTMENT OF DEFENSE CONTROLS ACCESS TO GUANTANAMO BAY, AND OUR ORGANIZATION MUST WORK WITH THEM TO ARRANGE YOUR VISIT. THE NEED TO COORDINATE WITH OUR GOVERNMENT FOR THIS VISIT MAY TAKE AS LONG AS TWO TO THREE MONTHS, AND WE REQUEST YOUR PATIENCE IN ADVANCE, BECAUSE

SECRET RELEASE LIBYA ONLY

IMG\_2144.JPG

SECRET RELEASE LIBYA ONLY

6 APRIL 2004

SUBJECT: GUANTANAMO BAY

1. IN RESPONSE TO YOUR REQUEST TO INTERVIEW LIBYAN NATIONALS AT GUANTANAMO, WE ORDER THE FOLLOWING INFORMATION.

2. PLEASE SEND AN OFFICIAL DIPLOMATIC NOTE TO THE U.S. INTEREST SECTION IN TRIPOLI FROM YOUR FOREIGN MINISTRY TO REQUEST TO VISIT DETAINEES AT GUANTANAMO BAY. PLEASE NOTE THAT WE DO NOT CONTROL WHICH SERVICES VISIT GUANTANAMO BAY AND FOR THE DATES APPROVED, THOUGH YOU MAY NOTE YOUR PREFERRED DATES.

3. PLEASE INCLUDE A COMPLETE LIST OF NAMES OF ANY DETAINEES WHO ARE TO BE INTERVIEWED WHO ARE NOT REPEAT NOT NATIONALS OF YOUR COUNTRY. IT IS NOT NECESSARY TO PROVIDE ADVANCE INFORMATION ON NATIONALS OF YOUR COUNTRY. PLEASE ALSO PROVIDE COMPLETE VISITOR INFORMATION (FULL NAME, DATE AND PLACE OF BIRTH, PASSPORT NUMBER WITH ISSUE AND EXPIRATION DATE, ANY OTHER NAME PREVIOUSLY USED).

4. THE U.S. DEPARTMENT OF DEFENSE CONTROLS ACCESS TO GUANTANAMO BAY, AND OUR ORGANIZATION WILL WORK WITH THEM TO ARRANGE YOUR VISIT. THE NEED TO COORDINATE WITHIN OUR GOVERNMENT FOR YOUR VISIT MAY TAKE AS LONG AS TWO TO THREE MONTHS, AND WE REQUEST YOUR PATIENCE IN ADVANCE. REGARDS.

SECRET RELEASE LIBYA ONLY



### صفحة غطاء رسالة الفاكس

المعلومات المتضمنة في هذا الفاكس من نوع:

URGENT عاجل جدا

IMMEDIATE عاجل

PRIORITY أولوية

ROUTINE عادي

HONG KONG LANDING REQUIREMENTS الموضوع:

26 MAR 04 / 0845 HRS تاريخ ووقت الارسال:

3 عدد الصفحات:

حديقة جوارح البحيرة الكورنيش  
2004-03-26

APR. 24. 1999 10:37PM

NO. 197 P.2

## CONFIDENTIAL

- (1) In order for the Non-Scheduled Flight to land in Hong Kong, you need to comply with certain regulations and a Permission to Land will be issued (A set of regulations is attached):
  - a) We assume that it is a private flight, which means that the flight is not operated for hire or reward. Please submit the Declaration of Flight Not Operated for Hire or Reward (see GEN 1.2 - 15 and para. 6).
  - b) Valid insurance document to show the aircraft carries appropriate insurance cover (see para. 3 and para. 6.2(i)).
  - c) Current Certificate of Airworthiness of the aircraft to be used.
- (2) You also need a local Aircraft Handling Agent and we recommend you use the Business Aviation Centre. The contact person is:

[REDACTED]  
Customer Service Manager  
Hong Kong Business Aviation Centre  
12 South Perimeter Road  
Hong Kong International Airport  
Lantau, Hong Kong  
[REDACTED]

You can discuss with the Agent about the handling charges as well as the landing fee charged by the Hong Kong Airport. You need to bring in sufficient cash (in US dollar) to settle the charges.

- (3) Please provide us with the full names and detail of travel documents of all aircrews. You have promised that there will be medical staff on board of the aircraft. Please also bring along all the original documents (which you have faxed to us earlier) for inspection.

## CONFIDENTIAL

H.K. 23. 1955 12:44PM

H.K. 24. 1955 10:38PM

NO. 197 P. 3

**CONFIDENTIAL**

- (4) It is agreed that the subject person will be moved together with his whole family (a total of six persons) on board of the same flight.
- (5) As the aircraft will only stay in Hong Kong for a short period of time and will depart once the family are on board, please arrange the aircrews to have sufficient time for rest and the plane has sufficient fuel before coming to Hong Kong. Please also provide a detail flight plan to us soonest.
- (6) It is appreciated that you can reply to us within today (26<sup>th</sup> of March Friday).

\*\*\*\*\*

**CONFIDENTIAL**

SECRET  
CLASSIFICATION OF THIS DOCUMENT SHALL REMAIN UNCLASSIFIED  
THE SERVICE HAS REVIEWED THAT LAST WEEKEND LINE  
[REDACTED] CHILDREN WHO  
[REDACTED] MATING/PARTNER  
[REDACTED] SERVICE HAS BEEN  
[REDACTED] [REDACTED]  
[REDACTED] [REDACTED]  
[REDACTED] [REDACTED]

- URGENT عاجل جدا
- IMMEDIATE عاجل
- PRIORITY أولوية
- ROUTINE عادي

Rendition of Abu Mudhir الموضوع:  
23 March 2004 02:30 AM تاريخ وقت ارسال:  
3 عدد الصفحات:

دولة تاريخ  
 23-3-2004  
 [REDACTED]

IMG\_2161.JPG



APR. 5.1999 12:19PM  
HK.22.189 R

SECRET

SECRET // U.S. ONLY // EXCEPT LIBYA

SUBJECT: RENDITION OF LIFG DEPUTY EMIR ABU MUNTHIR

OUR SERVICE HAS BECOME AWARE THAT LAST WEEKEND LIFG DEPUTY EMIR ABU MUNTHIR AND HIS SPOUSE AND CHILDREN WERE BEING HELD IN HONG KONG DETENTION FOR IMMIGRATION/PASSPORT VIOLATIONS. WE ARE ALSO AWARE THAT YOUR SERVICE HAD BEEN COOPERATING WITH THE BRITISH TO EFFECT ABU MUNTHIR'S REMOVAL TO TRIPOLI, AND THAT YOU HAD AN AIRCRAFT AVAILABLE FOR THIS PURPOSE IN THE MALDIVES.

OUR UNDERSTANDING IS THAT THE HONG KONG SPECIAL WING (SW) ORIGINALLY DENIED PERMISSION FOR YOUR AIRCRAFT TO LAND IN HONG KONG TO ENABLE YOU TO ASSUME CONTROL OF ABU MUNTHIR AND HIS FAMILY. HOWEVER, WE BELIEVE THAT THE REASON FOR THE REFUSAL WAS BASED ON INTERNATIONAL CONCERNS OVER HAVING A LIBYAN-REGISTERED AIRCRAFT LAND IN HONG KONG. ACCORDINGLY, IF YOUR GOVERNMENT WERE TO CHARTER A FOREIGN AIRCRAFT FROM A THIRD COUNTRY, THE HONG KONG GOVERNMENT MAY BE ABLE TO COORDINATE WITH YOU TO RENDER ABU MUNTHIR AND HIS FAMILY INTO YOUR CUSTODY.

IF PAYMENT OF A CHARTER AIRCRAFT IS AN ISSUE, OUR SERVICE WOULD BE WILLING TO ASSIST FINANCIALLY TO HELP UNDERWRITE THOSE COSTS. PLEASE BE ADVISED THAT IF WE PURSUE THAT OPTION, WE MUST HAVE ASSURANCES FROM YOUR GOVERNMENT THAT ABU MUNTHIR AND HIS FAMILY WILL BE TREATED HUMANELY AND THAT HIS HUMAN RIGHTS WILL BE RESPECTED; WE MUST RECEIVE SUCH ASSURANCES PRIOR TO ANY ASSISTANCE BEING PROVIDED.

FOR YOUR INFORMATION, THE HONG KONG SPECIAL ADMINISTRATIVE REGION IS GOVERNED BY A VARIETY OF LEGAL CONSTRAINTS REGARDING DEPORTATION AND CUSTODY OF ALIENS. ACCORDINGLY, WE BELIEVE THAT YOU WILL NEED TO PROVIDE SIGNIFICANT DETAIL ON ABU MUNTHIR (E.G., HIS TERRORIST/CRIMINAL ACTS, WHY HE IS WANTED, PERHAPS PROOF OF CITIZENSHIP). IT IS ALSO OUR UNDERSTANDING THAT HONG KONG OFFICIALS HAVE INSISTED THAT PRIOR TO TURNING ABU MUNTHIR OVER TO YOUR CUSTODY, THEY MUST RECEIVE CLEAR ASSURANCES FROM YOUR GOVERNMENT THAT ABU MUNTHIR AND HIS FAMILY WILL BE TREATED HUMANELY AND IN ACCORDANCE WITH HUMAN RIGHTS

IMG\_2162.JPG

REF ID: A66000

SECRET

SUBJECT:

STANDARDS. SPECIFICALLY, THE HONG KONG GOVERNMENT MUST HAVE A STIPULATION BEFORE ABU MUNTHIR COULD BE TURNED OVER THAT HE WILL NOT BE SUBJECT TO THE DEATH PENALTY IN LIBYA.

IN ADDITION, THE HONG KONG SPECIAL ADMINISTRATIVE REGION HAS REQUESTED THAT THE LIBYAN GOVERNMENT PROVIDE THEM SPECIFIC INFORMATION ON WHO WOULD BE ACCOMPANYING ABU MUNTHIR ON THE DEPORTATION/RENDITION AIRCRAFT, HOW MANY OFFICERS WOULD BE ONBOARD, AND THE DETAILS OF THE DEPORTATION/RENDITION PLAN. IN SHORT, WE BELIEVE THAT A DETAILED AND WELL-CRAFTED PLAN MUST BE PRESENTED TO THE HONG KONG GOVERNMENT IN ORDER TO PERSUADE THEM TO CONVEY ABU MUNTHIR AND FAMILY INTO YOUR CUSTODY.

IN ORDER TO FACILITATE THIS OPERATION, WE PROVIDE THE FOLLOWING INFORMATION IN HONG KONG FOR YOU TO CONTACT AS SOON AS POSSIBLE:

[REDACTED]

IF THERE ARE OTHER ISSUES OR CONCERNS, WE WOULD BE INTERESTED IN KNOWING HOW WE CAN HELP TO RESOLVE THEM. YOUR PROMPT RESPONSE TO THIS REQUEST IS GREATLY APPRECIATED. REGARDS.

[REDACTED]

SECRET

SECRET RELEASE LIBYA ONLY

## التعاون الأمريكي

وارد عن طريق الإبراق المشفر .

لتاريخ: 2004/03/17

إلى السيد : . موسى

من السيد : . ستيف

○ يسعدني أن أقتراح عليكم خطوة إضافية في إطار العلاقات القائمة بين جهازينا وذلك بإنشاء محطة لـ CIA في ليبيا وكنا تحدثنا في السابق عن هذا الموضوع .

○ وأن تعاون ليبيا في مجال أسلحة الدمار الشامل وموضوعات أخرى في مجالات التعاون الاستخباري فإن الوقت مناسب الآن للسير في هذه الخطوة . وأنا بصدد إرسال وفد إلى ليبيا برئاسة السيد [REDACTED] لكي يقدم لكم ولجهازكم ضابطين لهما خبرة ويمكنهما التحدث بالعربية وسيكونان في محطتنا في ليبيا .

○ سيخبركم [REDACTED] بالتفاصيل عبر الفاكس المشفر وسوف أذكر لكم ذلك . الضباط المقيمين في طرابلس في المستقبل هما : CIA :-



○ ظباط التحقيق :-

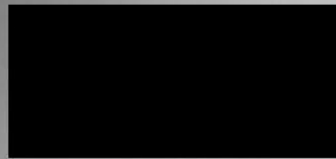



APR. 5. 1999 12:19AM

SECRET RELEASE LIBYA ONLY

كما أننا موافقين للعمل معكم في مجال إستجواب الازهابي الذي تم إعادته مؤخرا  
إلى بلدكم .  
وأرغب في إرسال عنصرين لكم من ظباطنا ونأمل تمكينهم من سؤال هذا  
الشخص مباشرة وإذا كنتم موافقين فسنقوم بإرسال هاذين الشخصين  
يوم 2004/03/25 . وسوف يبلغكم [REDACTED] بالتفاصيل.

**STEVE**



**American Cooperation**

**Arrived through encrypted telegraphy**

**Date: 17/03/2004**

**To Mr.: Moussa**

**From Mr.: Steve**

- I am pleased to suggest to you a further step in regards to the established relationship between our agencies and that is through establishing a CIA station in Libya, and we have talked previously about this subject matter.
- And that Libya's cooperation on the subject of Weapons of Mass Destruction and other issues in the matter of intelligence cooperation, makes now the proper time to take this step. And we are in the process of sending a delegation to Libya, with the presidency of Mr. [REDACTED], where he will introduce to you and your agency, officers with experience which can speak Arabic, whom will be in our station in Libya.
- [REDACTED] will tell you the details through encrypted fax, and I shall state this to you. Officers residing in Tripoli in the future are. CIA:-

[REDACTED]  
[REDACTED]  
[REDACTED]  
[REDACTED]

- **Investigation officers:-**

[REDACTED]  
[REDACTED]  
[REDACTED]

Also, we agree to work with you on the issue of terrorist interrogation which have recently been returned to your country.

And I wish to send two members of our officers to you, where we hope that they can interrogate this person directly, and if you agree, we shall send these two individuals on 25/03/2004. And [REDACTED] will fill you in on the details.

**STEVE**

SECRET RELEASE LIBYA ONLY

APR. 5. 1999 4:24AM  
APR. 16. 1999 2:07AM

NO. 159 P. 1

SECRET RELEASE LIBYA ONLY

17 March 2004

MEMO NUMBER: WT/04-0035  
SUBJECT: TRAVEL TO LIBYA

WE WISH TO ADVISE YOU THAT BELOW INDIVIDUALS WILL BE TRAVELING TO LIBYA. [REDACTED] AND [REDACTED] WILL BE WORKING WITH [REDACTED] IN SUPPORTING OUR ORGANIZATION IN TRIPOLI. PLEASE MAKE ARRANGEMENTS FOR [REDACTED] AND [REDACTED] TO PICK UP LIBYAN VISAS AT YOUR PEOPLE'S BUREAU IN LONDON ON 19 MARCH, DURING REGULAR BUSINESS HOURS.

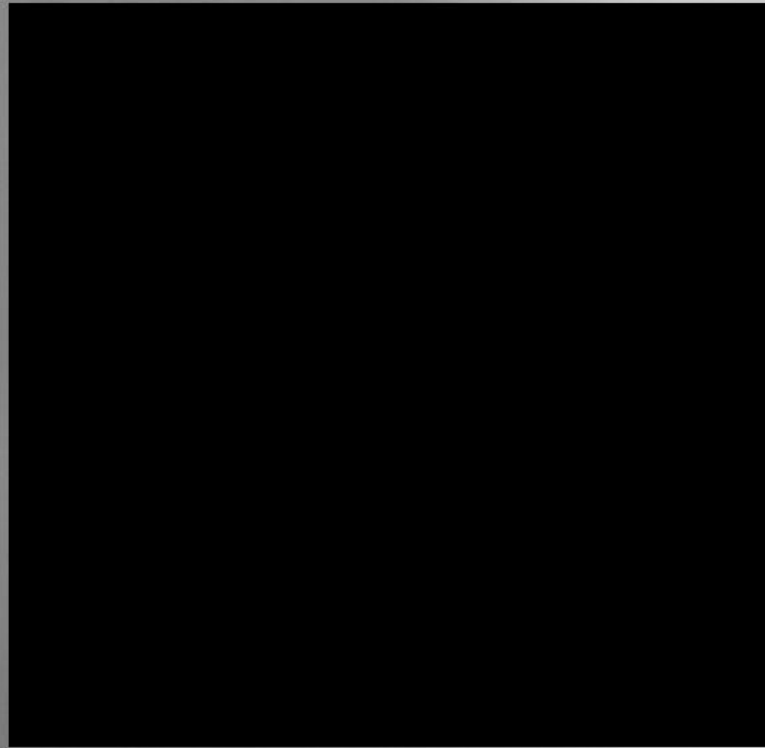

SECRET RELEASE LIBYA ONLY

32

IMG\_2167.JPG

APR.16.1999 2:08PM

NO.159 P.2

SECRET RELEASE LIBYA ONLY

THE FOLLOWING INDIVIDUALS WILL TRAVEL TO LIBYA ON 25 MARCH TO DISCUSS THE RECENT RENDITION. PLEASE MAKE ARRANGEMENTS FOR [REDACTED] AND [REDACTED] TO PICK UP LIBYAN VISAS AT YOUR PEOPLE'S BUREAU IN LONDON ON 24 MARCH, DURING REGULAR BUSINESS HOURS:

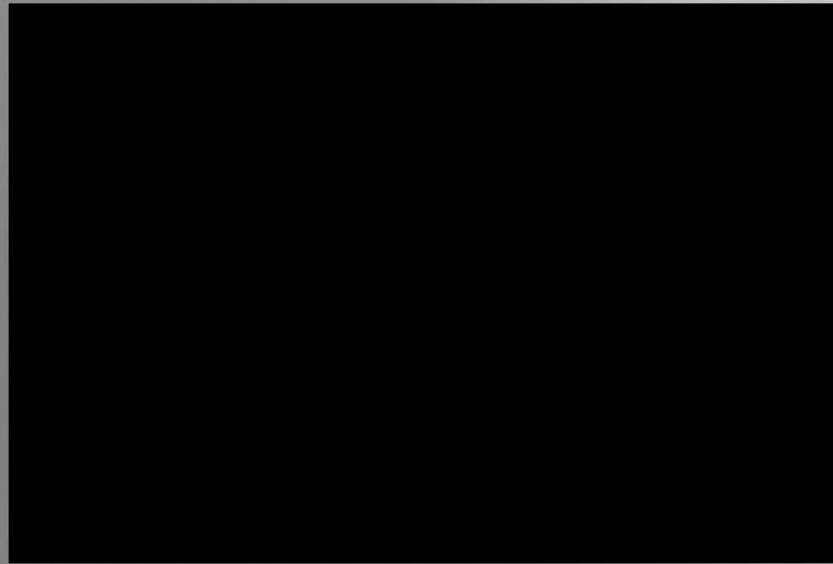

YOUR ASSISTANCE IS GREATLY APPRECIATED.

SECRET RELEASE LIBYA ONLY

32

IMG\_2168.JPG

APR. 5. 1999 12:19AM

SECRET RELEASE LIBYA ONLY

APR. 16. 1999 2:05AM

NO. 157 P. 2

Dear Musa,

I am glad to propose that our services take an additional step in cooperation with the establishment of a permanent CIA presence in Libya. We have talked about this move for quite some time, and Libya's cooperation on WMD and other issues, as well as our nascent intelligence cooperation mean that now is the right moment to move ahead. I am prepared to send [REDACTED] to Libya to introduce two of my officers to you and your service, arriving in Tripoli on 20 March. These two officers, both of whom are experienced and can speak Arabic, will initially staff our station in Libya. [REDACTED] will communicate the details via fax. I will call to confirm this with you.

We are also eager to work with you in the questioning of the terrorist we recently rendered to your country. I would like to send to Libya an additional two officers, and I would appreciate if they could have direct access to question this individual. Should you agree, I would like to send these two officers to Libya on 25 March. Again [REDACTED] will communicate the details to you.

Steve

32

IMG\_2169.JPG



APR. 5.1999 12:19PM

SECRET RELEASE LIBYA ONLY

APR. 5.1999 4:24PM

SECRET RELEASE LIBYA ONLY

6 MARCH 2004

MEMO NUMBER: WT/04-00033  
SUBJECT: SCHEDULE FOR THE RENDITION OF ABDULLAH AL-SADIQ

WE WISH TO PROVIDE YOU WITH IMPORTANT INFORMATION WITH REGARD TO THE UPCOMING RENDITION OF LIFG LEADER ABDULLAH AL-SADIQ AND HIS WIFE TO YOUR CUSTODY. THE AIRCRAFT FOR THIS OPERATION WILL TRAVEL ACCORDING TO THE FOLLOWING ITINERARY:

DATE	ARRIVE	LOCATION	DEPART	NOTES
6/7 MAR	2300 GMT	DULLES	0100 GMT	
7 MAR	1130 GMT	TRIPOLI	1330 GMT	FUEL
7 MAR	2000 GMT	SEYCHELLES		REMAIN OVERNIGHT
8 MAR		SEYCHELLES	1400 GMT	
8 MAR	2030 GMT	BANGKOK	2230 GMT	FUEL - 8000 U.S. GALLONS
9 MAR	0330 GMT	DIEGO GARCIA	0530 GMT	FUEL - 10,000 USG
9 MAR	1630 GMT	TRIPOLI	1830 GMT	FUEL - 3000 USG

AS NOTED ABOVE, THE PLANE WILL BE REMAINING OVERNIGHT IN THE SEYCHELLES, SO IT IS IMPERATIVE THAT YOUR OFFICERS HAVE THE PROPER DOCUMENTATION FOR THAT LOCATION. OTHERWISE, THEY WILL BE NOT BE ALLOWED TO LEAVE THE AIRCRAFT.

AS THE AMERICAN PERSONNEL UNDERTAKING THIS OPERATION ON THE AIRCRAFT WORK AS A TEAM, IT WOULD BE VERY USEFUL FOR COMMUNICATIONS PURPOSES IF THE ESO OFFICERS INVOLVED ARE ENGLISH SPEAKERS. WE ALSO RESPECTFULLY REQUEST THAT YOUR OFFICERS CLOSELY FOLLOW THE INSTRUCTIONS OF THE U.S. PERSONNEL TO AVOID ANY POTENTIAL PROBLEMS ON BOARD THE AIRCRAFT. THEREFORE, OUR REGULATIONS STIPULATE THAT YOUR OFFICERS REFRAIN FROM BRINGING WEAPONS OF ANY TYPE, CAMERAS, CELL PHONES, OR RECORDING DEVICES ON BOARD THE AIRCRAFT. THE U.S. OFFICERS WILL EXERCISE CONTROL OVER THIS OPERATION UNTIL THE DETAINEES ARE REMANDED TO YOUR GOVERNMENT IN TRIPOLI. YOUR SERVICE'S COOPERATION ON THIS MATTER IS GREATLY APPRECIATED.

SECRET RELEASE LIBYA ONLY

[Redacted] 6-3-2004

IMG\_2171.JPG

SECRET RELEASE LIBYA ONLY

6 MARCH 2004

MEMO NUMBER: WT/04-00031  
SUBJECT: PLANNING FOR THE CAPTURE AND RENDITION OF  
ABDULLAH AL-SADIQ

THE MALYSIAN GOVERNMENT HAS INFORMED US THAT THEY ARE PUTTING LIBYAN ISLAMIC FIGHTING GROUP (LIFG) LEADER ABDULLAH AL-SADIQ AND HIS PREGNANT (4 MONTHS) WIFE ON A COMMERCIAL FLIGHT FROM KUALA LUMPUR TO LONDON VIA BANGKOK ON THE EVENING OF 07 MARCH 2004, ALTHOUGH WE DO NOT YET HAVE SPECIFIC FLIGHT DATA. WE ARE PLANNING TO ARRANGE TO TAKE CONTROL OF THE PAIR IN BANGKOK AND PLACE THEM ON OUR AIRCRAFT FOR A FLIGHT TO YOUR COUNTRY. IT IS VITAL THAT ONE OF YOUR OFFICERS ACCOMPANY AL-SADIQ AND HIS WIFE ON OUR AIRCRAFT DURING THIS LEG OF THE JOURNEY (BANGKOK TO LIBYA) IN ORDER TO PROVIDE LEGAL CUSTODY OF AL-SADIQ'S SPOUSE.

TO EXPEDITE THE ABOVE SCENARIO AND MITIGATE POTENTIAL OBSTACLES TO A SUCCESSFUL RENDITION, WE REQUEST THAT YOUR OFFICERS IN KUALA LUMPUR AND BANGKOK REFRAIN FROM MAKING FURTHER REQUESTS OF THE MALYSIANS OR THE THAI ON THIS MATTER. YOUR COOPERATION IS GREATLY APPRECIATED.

WE ALSO APPRECIATE YOUR ALLOWING OUR SERVICE DIRECT ACCESS TO AL-SADIQ FOR DEBRIEFING PURPOSES ONCE HE IS IN YOUR CUSTODY. PLEASE BE ADVISED THAT WE MUST BE ASSURED THAT AL-SADIQ WILL BE TREATED HUMANELY AND THAT HIS HUMAN RIGHTS WILL BE RESPECTED. WE MUST RECEIVE THESE ASSURANCES PRIOR TO ANY ASSISTANCE OUR SERVICE CAN PROVIDE TO YOUR SERVICE REGARDING HIS DEBRIEFINGS. IN ADDITION, IT IS OUR STANDARD PRACTICE THAT OUR OFFICERS CANNOT CONDONE ANY SIGNIFICANT PHYSICAL OR PHYSIOLOGICAL ASPECTS, SUCH AS DIRECT PHYSICAL CONTACTS, UNUSUAL MENTAL DURESS, UNUSUAL PHYSICAL RESTRAINTS, OR DELIBERATE ENVIRONMENTAL DEPRIVATIONS BEYOND THOSE REASONABLY REQUIRED TO ENSURE THE SECURITY AND SAFETY OF OUR OFFICERS AND TO PREVENT THE ESCAPE OF THE DETAINEES.

YOU CAN CONTACT [REDACTED] IN HIS OFFICE AT [REDACTED]  
OR VIA HIS CELL PHONE [REDACTED]. REGARDS

SECRET RELEASE LIBYA ONLY

درود بتاريخ 6-3-2004

IMG\_2172.JPG

APR 3 1999 11:52PM

NO. 133 P. 1

SECRET RELEASE LIBYA ONLY

4 MARCH 2004

MEMO NUMBER: WT/04-00031  
SUBJECT: CLARIFICATION REGARDING THE RENDITION OF ABU  
ABDULLAH AL-SADIQ

THANK YOU FOR THE HOSPITALITY THAT YOUR SERVICE SHOWED  
OUR OFFICERS DURING THEIR RECENT VISIT TO YOUR COUNTRY. AS  
YOU ARE AWARE, OUR DISCUSSIONS WERE VERY PRODUCTIVE AND WE  
ARE COMMITTED TO DEVELOPING THIS RELATIONSHIP FOR THE  
MUTUAL BENEFIT OF BOTH OF OUR SERVICES.

OUR SERVICE IS COMMITTED TO RENDERING THE TERRORIST  
ABU ABDULLAH AL-SADIQ TO YOUR CUSTODY. TO THIS END, WE  
HAVE BEEN IN TOUCH WITH MALAYSIAN AUTHORITIES TO HELP  
FACILITATE THE TRANSFER OF CUSTODY IN ATIMELY MANNER. WE  
DO NOT YET HAVE ALL THE DETAILS FROM OUR STATION IN KUALA  
LUMPUR REGARDING HOW AND WHEN THIS TRANSFER WILL TAKE  
PLACE, BUT WE ARE VERY HOPEFUL FOR A EXPEDITIOUS RESOLUTION  
TO THIS MATTER.

WE WILL PROVIDE YOU WITH THE DETAILS AS SOON AS THEY  
ARE AVAILABLE TO US.

THANK YOU AND BEST REGARDS.

SECRET RELEASE LIBYA ONLY

وردت بتاريخه

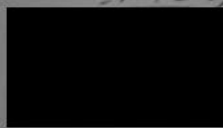

ص

Essentials

IMG\_2173.JPG



SECRET RELEASE LIBYA ONLY

4 MARCH 2004

MEMO NUMBER: WT/04-00030  
SUBJECT: URGENT REQUEST REGARDING THE EXTRADITION OF  
ABDULLAH AL-SADIQ FROM MALAYSIA

WE ARE WORKING ENERGETICALLY WITH THE MALAYSIAN GOVERNMENT TO EFFECT THE EXTRADITION OF ABDULLAH AL-SADIQ FROM MALAYSIA. THE MALAYSIANS HAVE PROMISED TO COOPERATE AND TO ARRANGE FOR SADIQ'S TRANSFER TO OUR CUSTODY. OF COURSE, ONCE WE HAVE SADIQ IN CUSTODY, WE WILL BE VERY HAPPY TO SERVICE YOUR DEBRIEFING REQUIREMENTS AND WE WILL SHARE THE INFORMATION WITH YOU.

WE ARE AT A DELICATE POINT IN OUR DISCUSSIONS WITH THE MALAYSIANS, AND WE BELIEVE FURTHER PRESSURE ON THE MALAYSIANS IS NOT NEEDED AT THIS TIME. THEREFORE, WE RESPECTFULLY REQUEST THAT YOU TEMPORARILY CEASE ANY FURTHER ENGAGEMENT WITH THE MALAYSIAN GOVERNMENT ON THE SUBJECT OF SADIQ UNTIL WE HAVE CUSTODY OF SADIQ OR JUDGED THAT THE MALAYSIANS ARE UNWILLING TO COOPERATE WITH THE U.S. GOVERNMENT.

YOUR ASSISTANCE IN THIS MATTER IS GREATLY APPRECIATED.  
REGARDS.

*Handwritten:* 64-03-03  
[Redacted]

SECRET RELEASE LIBYA ONLY

[Redacted]

IMG\_2174.JPG

SECRET RELEASE LIBYA ONLY

1 MARCH 2004

MEMO NUMBER: WT/04-00029  
SUBJECT: URGENT REQUEST IN SUPPORT OF THE EXTRADITION OF  
IBRAHIM ALI ABUBAKER TANTUSH FROM SOUTH AFRICA TO LIBYA

THE GOVERNMENT OF SOUTH AFRICA AND THE SOUTH AFRICAN POLICE SERVICE (SAPS) HAVE COMMUNICATED TO US THAT THEY ARE EAGER TO EXTRADITE IBRAHIM ALI ABUBAKER TANTUSH, AKA ABDULLAH AL-SAIRI, AS SOON AS POSSIBLE. THEY HAVE PROVIDED THE FOLLOWING INFORMATION FOR YOUR SERVICE'S USE TO CONTACT THE INTERPOL OFFICER IN SOUTH AFRICA REGARDING DISPOSITION OF THE AL-SAIRI CASE. [REDACTED] WILL BE ABLE TO PROVIDE YOU WITH THE SPECIFIC REQUIREMENTS WHICH NEED TO BE MET IN ARRANGING THE EXTRADITION.

[REDACTED]

WE WOULD ALSO LIKE TO PASS THE SOUTH AFRICANS A POINT OF CONTACT IN YOUR DIPLOMATIC MISSION IN PRETORIA. PLEASE ADVISE THE NAME AND CONTACT SPECIFICS AND WE WILL PASS THE INFORMATION TO THE SOUTH AFRICANS.

WE NOTE THAT A BAIL HEARING FOR AL-SAIRI IS SCHEDULED FOR 09 MARCH 2004. ALTHOUGH BAIL WILL BE DENIED, WE ARE CONCERNED THAT AL-SAIRI'S LAWYERS HAVE BEEN ATTEMPTING TO GENERATE MEDIA INTEREST IN THE EXTRADITION, CLAIMING THAT IT IS ILLEGAL. IN ADDITION, AN INTERNET WEB SITE HAS BEEN CREATED TO DRAW ATTENTION TO AL-SAIRI'S CASE. THEREFORE, WE ENCOURAGE YOUR REPRESENTATIVES TO CONTACT SAPS OFFICER [REDACTED] AS SOON AS POSSIBLE.

YOUR ASSISTANCE IN THIS MATTER IS GREATLY APPRECIATED. REGARDS.

SECRET RELEASE LIBYA ONLY

2004.3.2 ع.ت. 2/19

[REDACTED]

22

IMG\_2175.JPG

MAR 24 1999 9:51 PM

NO. 805 P. 1  
NO. 123 P. 1

SECRET RELEASE LIBYA ONLY

24 FEBRUARY 2004

MEMO NUMBER: WT/04-00027  
SUBJECT: URGENT REQUEST FOR ACTION REGARDING ISRAHIM ALI  
ABUBAKER TANTOUSH, AKA AL-SAIRI

AS WE DISCUSSED DURING OUR MEETING IN TRIPOLI ON FRIDAY 20 FEBRUARY 2004, ACTION NEEDS TO BE TAKEN ON BEHALF OF THE LIBYAN GOVERNMENT IN ORDER TO FACILITATE THE EXTRADITION OF ISRAHIM ALI ABUBAKER TANTOUSH, AKA AL-SAIRI, FROM SOUTH AFRICA TO LIBYA. SPECIFICALLY, THE LIBYAN GOVERNMENT NEEDS TO DO THE FOLLOWING:

- ENSURE THAT INTERPOL ISSUES AN ARREST WARRANT FOR TANTOUSH;
- MAKE A FORMAL EXTRADITION REQUEST TO THE SOUTH AFRICAN GOVERNMENT (THIS WILL INVOLVE HAVING A LIBYAN REPRESENTATIVE IN SOUTH AFRICA GET IN CONTACT WITH SOUTH AFRICAN MINISTRY OF FOREIGN AFFAIRS, THE SOUTH AFRICAN POLICE SERVICE, AND/OR INTELLIGENCE SERVICE TO DETERMINE THE FORMAL REQUIREMENTS FOR AN EXTRADITION REQUEST); AND
- PROVIDE US WITH A POINT OF CONTACT (NAME AND PHONE NUMBER) WITHIN THE LIBYAN EMBASSY IN PRETORIA WHO IS HANDLING THIS ISSUE.

WE WOULD LIKE TO STRESS THAT THE SOUTH AFRICAN GOVERNMENT WILL SET TANTOUSH FREE IF THE LIBYAN GOVERNMENT DOES NOT FOLLOW THROUGH WITH THE SOUTH AFRICAN GOVERNMENT WITHIN 45 DAYS (BEGINNING ON 20 FEBRUARY), THROUGH DIPLOMATIC CHANNELS. CONTACT WITH INTERPOL ALONE WILL NOT BE SUFFICIENT.

WE LOOK FORWARD TO CONTINUING TO WORK WITH YOU ON THIS IMPORTANT MATTER.

*Handwritten:* [redacted]  
[redacted]  
[redacted]

SECRET RELEASE LIBYA ONLY

[redacted]  
*Handwritten:* 3200312-27



24-FEB-2003 09:42 FROM 00000000000000000000

P.01/01

24-FEB-2003 09:42 FROM 00000000000000000000  
18-FEB-2003 10:56 FROM 00000000000000000000

TO

P.01/01

FOR THE ATTENTION OF

We would be most grateful to your Service for assistance on the following questions:



Abu AYYUB AL LIBI

3. We would also be grateful for a photograph of AL MAHDI MUSTAFA AL MAHDI JOLDA aka ABU AYUB and ABD AL WAHED, born 1965 in Tripoli, whose details your Service passed to SIS on 29/1/03.

Unfortunately, the photos of subjects sent to us as photocopies or faxes are of poor quality.

Many thanks

We look forward to seeing you soon

[Redacted signature]

22744 P.01

7074 P.01

24-FEB-2003 00:00  
FROM: [REDACTED]

01/201  
P. 01/01  
P. 01/01

London SE1  
19 June 2003

**FOR THE URGENT PERSONAL ATTENTION OF MUSA KUSA,  
DEPARTMENT OF INTERNATIONAL RELATIONS AND  
COLLABORATION**

Greetings to Musa from Steve and Mark. We hope that you are well.

When we met together in London on 14 May, we discussed the technical visit to your WMD programmes planned for a joint CIA and SIS team of experts. You and Saif al-Islam asked for a note of the response which the government of the United States and Her Majesty's government would make to a successful and complete technical visit.

Condoleezza Rice has told CIA that if Libya proceeds with its proposal to destroy its WMD programmes, Libya would be welcomed back to rejoin the community of nations and all that goes with that. There would be great opportunities that could come of such a rejoining.

HMG, in turn, is of the view that, provided HMG is confident that Libya is irreversibly engaged in dismantling its WMD programmes, Libya can expect HMG to:

- help them obtain a clean bill of (nuclear) health from the IAEA;
- work with them to smooth their accession to the Chemical Weapons Convention, as HMG did with South Africa;
- argue in Brussels for a new relationship between Libya and the EU, including full participation in the Barcelona (Euromed) Process and a lifting of the embargo on conventional arms sales; and that
- ultimately, after there is a public demonstration of Libya's irreversible move to disarmament of WMD, HMG would hope that it would be possible to arrange a personal meeting between the Prime Minister and the Leader.

This text has been shared with CIA and they have confirmed it.

Steve and I would like to meet with you soon. Could you give me a ring so that we can suggest some dates?

Thank you.

Mark.

TOTAL P. 01  
TOTAL P. 01

22-SEP-2003 12:37 FROM [REDACTED]  
22-SEP-2003 02:24 FROM [REDACTED]

P.01/01

London SE1  
22 September 2003

FOR THE URGENT PERSONAL ATTENTION OF MUSA KUSA,  
DEPARTMENT OF INTERNATIONAL RELATIONS AND  
COLLABORATION

Dear Musa

Preparations are now well in hand for the US/UK technical visit scheduled to begin on 4 October. I attach a note prepared jointly with CIA setting out the team's mission and an outline of the work they and their Libyan colleagues will have to undertake as a prelude to the involvement of the wider international community.

Steve Kappes asked me to pass on his regards and his phone number, something he forgot to give you when he visited Tripoli. His Washington numbers are:

[REDACTED]

I will be in touch again with the names of those in the technical team and with details concerning the flight and other arrangements.

I enjoyed speaking to you the other day and look forward to seeing you here this week. I will await your call on arrival.

Yours ever

Mark

22-12-0

[REDACTED]

22-SEP-2003 12:37 FROM [REDACTED]

18-OCT-2003 17:52 TRM1

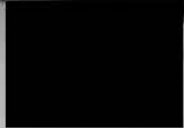

P. 01/01  
P. 01/01  
P. 01/01

London  
SE1  
10 October 2003

**FOR THE URGENT PERSONAL ATTENTION OF MUSA KUSA,  
DEPARTMENT OF INTERNATIONAL RELATIONS AND  
COLLABORATION**

Thank you for your hospitality during our recent visit. Please find below information you requested in preparation for the technical visit by the joint UK/US team.

If convenient to you, we will fly to Libya on the afternoon of Sunday 19 October, so that we are ready to begin on work on Monday 20th. We are planning to return home on Monday 27 October. Unless you inform us otherwise, we were not intending to apply for visas and assume that you will make arrangements to receive us. Could you please confirm that you will also make arrangements for the air crew.

The aircraft is a Boeing 737 Business Jet with tail number N313P. Please could you confirm that we should fly into Wheelus airbase. I would be grateful if you could provide the terminal approach procedures and radio frequencies that the aircraft should use.

Technical Team

UK team: Mark Allen



US team: Steve Kapps



Air Crew:

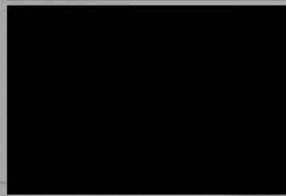



15-DEC-2003 08:14 FROM 00000000000000000000  
25-DEC-2003 14:15 FROM 00000000000000000000

P.01/01  
P.01/03

FOLLOWING PLEASE PERSONAL FOR  
MUSA KUSA FROM MARK (3 pages)

*Dear Musa*

The following two pages are a copy of letter I am sending by hand of [redacted] He is unable to travel today and so I send it by fax.

[redacted] tells me that you will come to London tomorrow. This is very good news and we look forward to seeing you here.

Khalid is coming to lunch today and it is a pity you cannot join us.

Happy Christmas

*your friend*

*mark*

*25 Dec '03*

*25/12/2003*  
[redacted]

[redacted] 2003.12.22  
2003.12.12 ابرقت بتاع

TOTAL P.01

TOTAL P.01



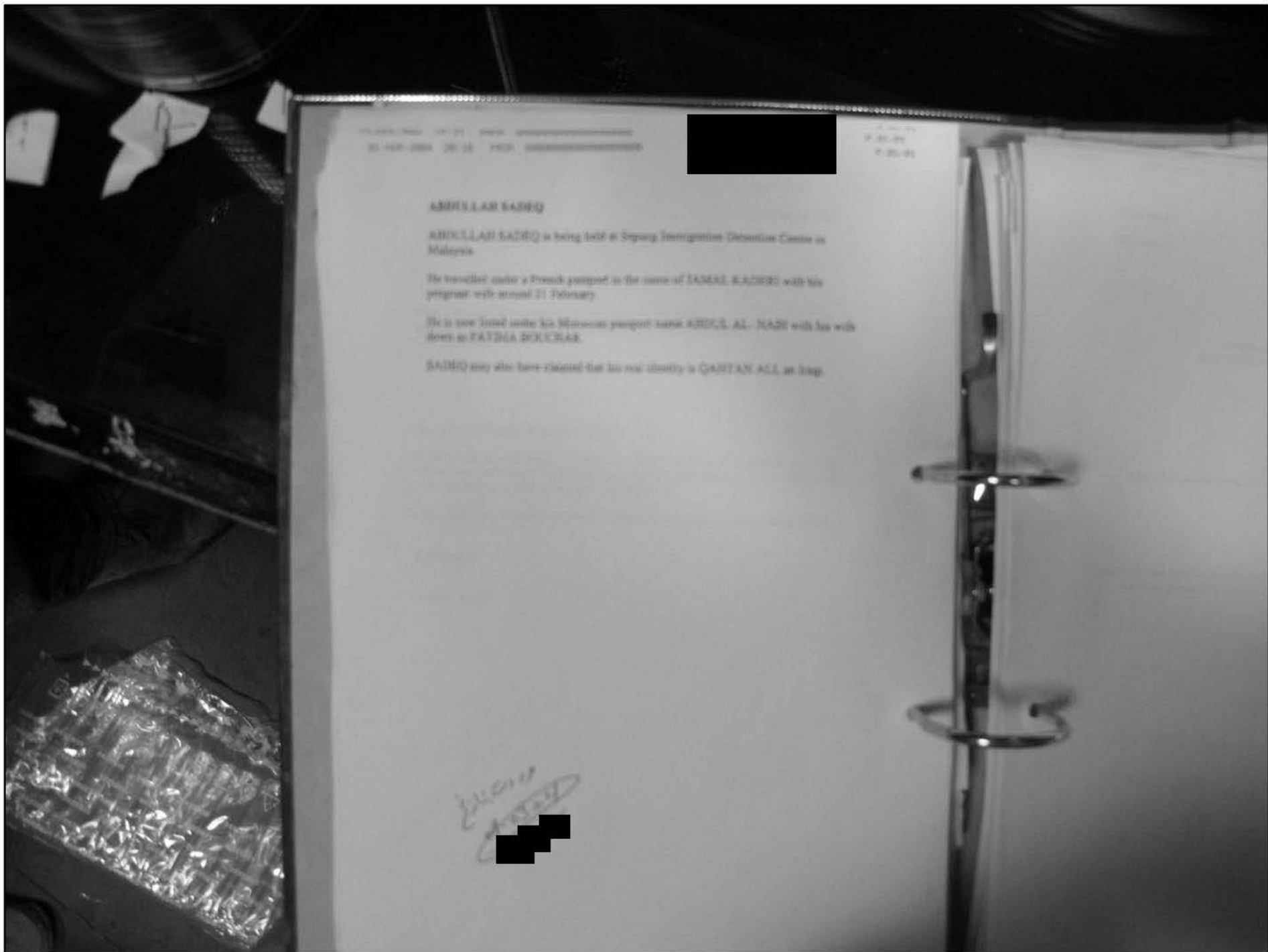

PLAINT No. 17-11 2018  
01-140-2004 20-18 PCH

[Redacted]

P. 20-18  
P. 20-18

**ABDEL LAH SADIQ**

ABDEL LAH SADIQ is being held at Sepang Immigration Detention Centre in Malaysia.

He travelled under a French passport in the name of JAMES SADIQ with his program will arrival 21 February.

He is now listed under his Moroccan passport name ABDEL AL SADI with his wife listed as FATMA DJICHAJ.

SADIQ may also have claimed that his real identity is QANTAN ALI al Iraq.

*Handwritten signature*  
[Redacted]

IMG\_2264.JPG

**ABDULLAH SADEQ**

ABDULLAH SADEQ is being held at Sepang Immigration Detention Centre in Malaysia.

He travelled under a French passport in the name of JAMAL KADERI with his pregnant wife around 21 February.

He is now listed under his Moroccan passport name ABDUL AL- NABI with his wife down as FATIMA BOUCHAR.

SADEQ may also have claimed that his real identity is QAHTAN ALI, an Iraqi.

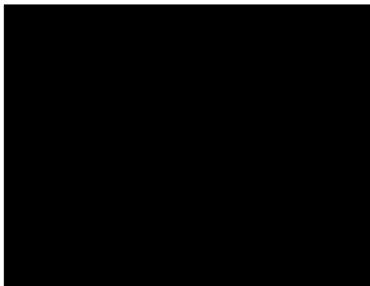

H-81/02

London  
SE1  
18 March 2004

**FOR THE URGENT PERSONAL ATTENTION OF MUSA KUSA,  
DEPARTMENT OF INTERNATIONAL RELATIONS AND  
COLLABORATION**

Following message for Musa in Tripoli from Mark in London

1 I am so grateful to you for your help in sorting out this visit to the Leader by our Prime Minister. The diplomats had failed to get organised. What you did made a great impression at No 10. They are grateful too.

2 A member of the Prime Minister's staff [redacted] will be travelling to Libya shortly to discuss arrangements. He will be coming on diplomatic channels.

3 No 10 have asked me to put to you their request that there be no publicity for the Prime Minister's visit now or over the next few days - that is well in advance of the visit. Since Madrid everyone is extra security conscious.

4 In No 10, their present thinking is that there should not (not) be a press conference for the Leader and the Prime Minister. (After reading the British press in recent weeks this seems to me only sensible. The Prime Minister will have 60 journalists with him). They are considering whether to propose that the Leader and the Prime Minister both make a short statement to the press. I think this will be followed up by the diplomats and maybe [redacted].

5 No 10 however are keen that the Prime Minister meet the Leader in his tent. I don't know why the English are fascinated by tents. The plain fact is that the journalists would love it. My own view is that it would give a good impression of the Leader's preference for simplicity which I know is important to him. You may have seen very different press coverage of the Prime Minister in Riyadh. Anyway if this is possible, No 10 would be very grateful.

6 No 10 are expecting that the visit will take place in Tripoli and not Sirte. Apparently it is important that the journalists have easy access to hotels and so on where there may be facilities for them to file their stories to their newspapers.

7 No 10 have asked me to accompany the Prime Minister so I am very much looking forward to seeing you next Thursday.

8 No 10 have asked whether I could get an office car. Tripoli a few days before the visit also would be to contact with Sirte. I think this would give them comfort in the eventuality would work out well. They are very keen that the visit is a great success. I am thinking of asking/asking someone from Rome. I will be in touch separately about this.

[Handwritten signature]

[Redacted signature block]

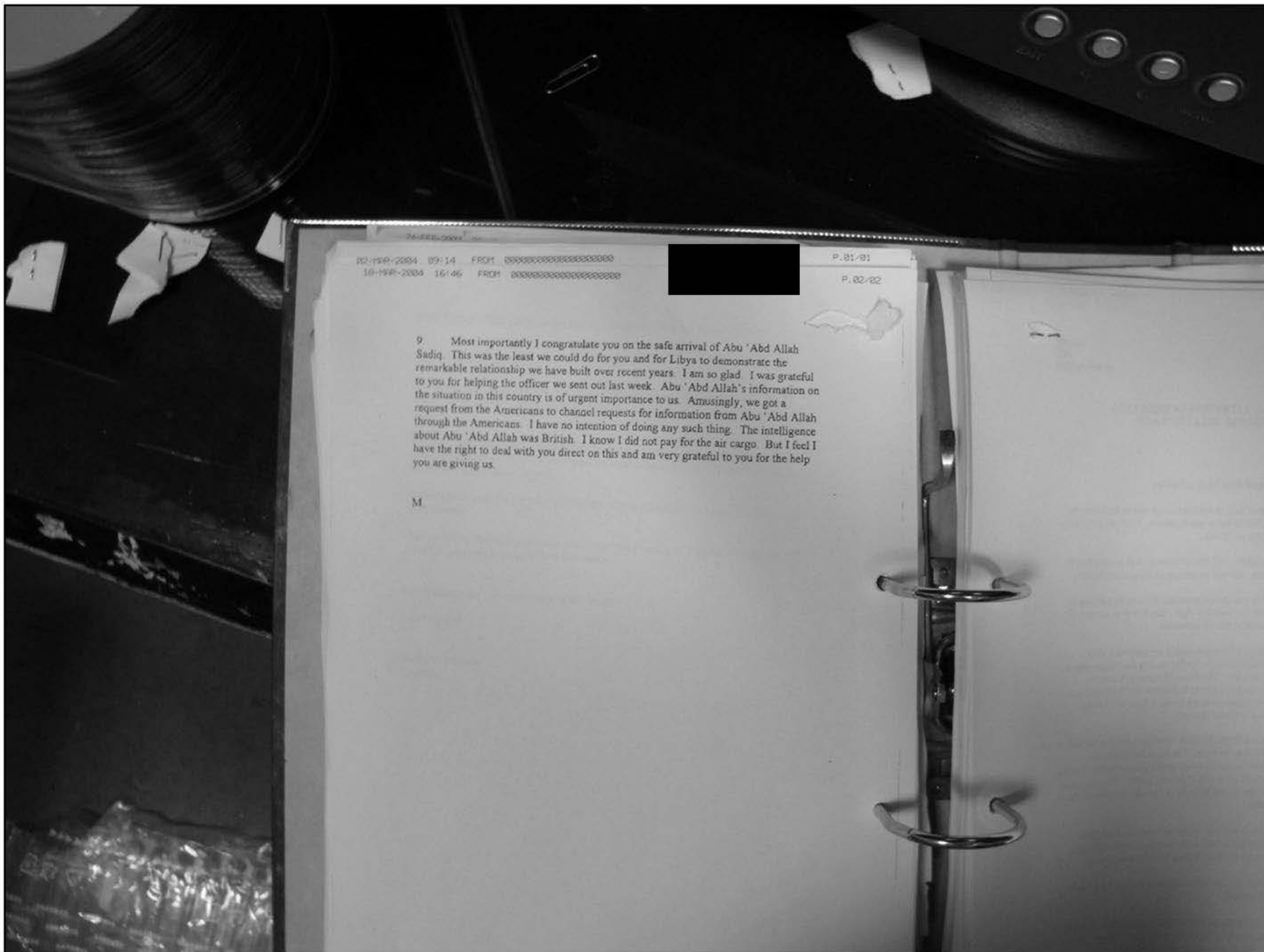

74-888-2004  
02-194-2004 09-14 FROM [REDACTED]  
10-194-2004 10-14 FROM [REDACTED]

P. 01/01  
P. 02/02

9. Most importantly I congratulate you on the safe arrival of Abu 'Abd Allah Sadiq. This was the least we could do for you and for Libya to demonstrate the remarkable relationship we have built over recent years. I am so glad I was grateful to you for helping the officer we sent out last week. Abu 'Abd Allah's information on the situation in this country is of urgent importance to us. Amusingly, we got a request from the Americans to channel requests for information from Abu 'Abd Allah through the Americans. I have no intention of doing any such thing. The intelligence about Abu 'Abd Allah was British. I know I did not pay for the air cargo. But I feel I have the right to deal with you direct on this and am very grateful to you for the help you are giving us.

M

IMG\_2267.JPG

23-APR-2004 15:36 FROM 00000000000000000000

P.01/01

FOR THE ATTENTION OF [REDACTED] INTERNATIONAL RELATIONS DEPARTMENT

Message reference number: L006/04 of 23 April 2004

Subject: ABU ZINAD

Our thanks for the information which you provided to us on ABU ZINAD also known as MUHAMMAD ABU FARSAN, from your discussions with [REDACTED]

We note that ABU ZINAD is reported to have travelled to Holland from China on a false passport. We would be grateful if you could provide us with any further details you might have about the passport he used, and who he travelled with, and when this travel took place. Do you also have a photograph of ABU ZINAD?

We would appreciate any information you might have, from [REDACTED] or other sources, on the role which ABU ZINAD played within the Libyan Islamic Fighting Group since he joined the organisation.

We would like to share the information on ABU ZINAD with Dutch liaison in The Hague, in case they can assist us in identifying ABU ZINAD if he is there. We would be grateful for your approval for this.

Many thanks for your assistance.

[REDACTED]

*L006/04/23*  
[REDACTED]

TOTAL P.01

TOTAL P.01



صفحة غطاء رسالة الفاكس

البيانات المتضمنة في هذا الفاكس من نوع:

- URGENT عاجل جدا
- IMMEDIATE عاجل
- PRIORITY أولوية
- ROUTINE عادي

Rendition of Abu Almondhir From Hong Kong الموضوع:  
23 March 2004 تاريخ وقت الارسال:  
 عدد الصفحات: 22

المرتب بتاريخ 25-3-2004  
 رقم الفاكس المرتب له 6



لا ذمات لمة بكون  
مؤتمرات شعبية

1

الجمهورية العربية الليبية  
الشعبية الاشتراكية العظمى  
الليقة الشعبية العامة للعدل والامن العام

التاريخ  
2004 / 03 / 24

363 / 27 / 6

FROM:- INTERPOL TRIPOLI  
TO: INTERPOL Hong Kong  
OUR REF:- 6/27/363

PRIORITY: - URGENT

SUBJECT: - LIBYAN NATIONAL:- SAMI MOSTEFA ES-  
SAIDI,BORN 1966.

- WE HAVE BEEN INFORMED THAT THE A/M SUBJECT IS NOW  
DETAINED AT YOUR SECURITY AUTHORITIES WITH A FORGED  
FRENCH PASSPORT IN THE NAME OF HISHAM OR HESHAM  
MOHAMED ACCOMPANIED BY HIS WIFE AND HIS CHILDREN.  
- THE A/M SUBJECT IS CIRCULATED BY IPSPG/FUSION TASK FORCE /LIST

PLEASE FIND AN ENCLOSED INFORMATION CARD CONTAINING THE  
CRIMES AND THE TERRORIST ACTIVITIES THAT HE COMMITTED AND HE  
IS WANTED TO LIBYAN JUDICIAL AUTHORITIES IN ORDER TO TRIAL HIM

ACCORDING TO THE LIBYAN PANEL CODE THE PUNISHMENT OF THE  
CRIMES HE COMMITTED IS A LIFE IMPRISONMENT AS AMAXIMUM  
PENALTY.

- ALSO ,THERE COULD NEITHER BE A CRIME NOR APUNISHMENT  
WITHOUT A LAW,AND THAT THE CRIME IS A PERSONAL ISSUE FOR  
WHICH THE CRIMINAL SHOULD BE PUNISHED.  
WE ALSO ENCLOSE AN OFFICIAL DOCUMENT TO PROVE HIS LIBYAN  
NATIONALITY.  
THEREFORE ,WE WOULD BE GRATFULL IF YOU COULD DEPORT HIM TO  
LIBYA.

WE ARE LOOKING FOR TO HEARING FROM YOU

THANK YOU FOR YOUR CO- OPERATION

N.C.B. TRIPOLI - LIBYA



لجنة الديمقراطية بدمشق  
مؤتمرات شعبية

(2)

التاريخ  
الرقم: 24/03/2004

الجمهورية العربية الليبية  
الشعبية الاشتراكية العظمى  
للجنة الشعبية العامة للعدل والأمن العام

الرقم: 363.27.6

من: - اتريبول طرابلس  
الى اتريبول هونج كونج

الرقم: - 363/27/6

الموضوع: - ساسي مصطفى خليفه الساعدي  
وابن خدوجه باتون  
مواليد طرابلس 1966

\*المذكور اعلاه محجوز الان لدى سلطات الامن في هونج كونج بجواز سفر فرنسي مسرور  
باسم هشام محمد ... صحبة زوجته وابنته .

- المضي معتم عليه من طرف I.P.S.G تحت رقم [REDACTED] بتاريخ [REDACTED]
- مرفق إقتاله المعلومات المحتوية على الجرائم والأفعال الارهابية الثابتة في حقه  
والمطلوب للعدالة امام السلطات القضائية الليبية لمحاكمة عنها .
- علما بان الجرائم المطلوب من اجلها لا تتعدى العقوبة المقررة لها في التشريعات الليبية  
النافذة عقوبة السجن المؤبد ... كاقصى عقوبة .
- كما بان لا جريمة ولا عقوبة الا بنص قانوني .... وان الجرم مسالة شخصية يعاقب  
عنها الجنائي فقط دون غيرها .
- كما ترفق مستند رسمي يثبت جنسية الليبية .

لذلك نأمل ترحيله الى الجماهيرية العظمى .

والسلام عليكم ورحمة الله وبركاته





3

IPSG / FUSLONT TASK FORCES LIST



SAMI MOSTEFA ES -SAIDI  
Born : 1966 . MATHENAME : KHADOUJA  
BANOUN  
(LIBYAN NATIONALTY)

الجمهورية العربية الليبية  
الشعبية الاشتراكية العظمى  
اللجنة الشعبية العامة للعدل والأمن العام



لائحة  
بدون مؤتمرات شعبية

مكتبة

ملف رقم : .....

التاريخ : .....  
الموافق : .....

إلى / من يهـ الأمر :

السلام عليكم ،،

انطلاقاً من مبادئ وأحكام قانوني العقوبات والإجراءات الجنائية الليبية .  
وإيماءاً إلى الحقوق والنصوص التي احتوتها وثيقة حقوق الإنسان الليبية .  
يرد أمين اللجنة الشعبية العامة للعدل والأمن العام أن يؤكد على ضمان تنفيذ النفاط الآتية :

❖ أولاً :

إن العقوبة والمجرمة شخصية ... لا تمس إلا الشخص المذنب فقط دون غيره من أفراد أسرته جميعاً مهما  
قررت أو بدت صلة القرابة بهم .

❖ ثانياً :

عدم جوازية محاكمة أي شخص دون استجوابه والتحقيق معه بحضور محاميه الذي يختاره شخصياً .

❖ ثالثاً :

مدة التوقيف والحبس الاحتياطي محددة قانوناً .

❖ رابعاً :

التحقيق في القضايا يكون بمعرفة النيابة العامة ، والحكم فيها من طرف المحاكم وهي (جزئية . ابتدائية .  
استئناف . عليا) .



21

الجمهورية العربية الليبية  
الشعبية الاشتراكية العظمى  
اللجنة الشعبية العامة للعدل والأمن العام



لاديمقراطية  
بدون مؤتمرات شعبية

مكتب المدعي

ملف رقم : .....

التاريخ : .....  
الموافق : .....

❖ خامساً :

المحكوم عليه حق التماس إعادة النظر أمام المحكمة العليا .

❖ سادساً :

لا يجوز مطلقاً إيقاف أو حبس أو اتهام سوى المتهم فقط ... شرط أن تكون الأدلة كافية على الإدانة ... والأدلة التباينة العامة لها صلاحية التقرير الأوجه لعدم الجرمية ... أو لعدم كفاية الأدلة .

❖ سابعاً : (عقوبة الإعدام) .

لا يجوز الحكم بها إلا عندما تشكل جريمة المتهم مساساً للمجتمع وتهدداً له ... وليس تهدداً لشخص بعينه فقط .

❖ ثامناً :

أي شك يفسر لمصلحة المتهم مبدأ ملزم للقضاء أثناء سير الجلسة والحكمة .

والسلام عليكم ...

محمد علي المصراحي

أمين اللجنة الشعبية العامة للعدل والأمن العام



سرت في 2004/3/5



22

الجمهورية العربية الليبية  
الشعبية الاشتراكية العظمى  
اللجنة الشعبية العامة للعدل والأمن العام



لا ديمقراطية  
بدون مؤتمرات شعبية

مكتب العدل

ملف رقم : .....

التاريخ : .....

الموافق : .....

**To whom it may concern : -**

Outbursting from the principles and provisions of the libyan laws of penalties and criminal procedures.

And indicating to the rights and provisions that libyan charter of human rights contained ; the Secretary of GENERAL PEOPLE'S COMMITTEE of JUSTICE and PUBLIC SECURITY would like to reassure to guarantee the implement of the following points:

**Firstly** : The crime and penalty is personal , it only incriminates the guilty person far from his family whatever his relationship was closer or farther from him .

**Secondly** : Any person should not be tried without being investigated and engaged with the presence of a lawyer of him to be personally opted,

**Thirdly** : period of detention and provisional detention are personally limited ,  
**Fourthly** : investigation of case must be done by attorney - general and must be sentenced by courts i.e. (criminal court , court of first instance , court of appeals and supreme court ) .

**Fifthly** : the condemned person has the right to consume the judgement before the supreme court .

**Sixthly** : absolutely it is not allowed to detain to imprison or to charge, except the charged a person on condition that evidence must be sufficient for condemning ... otherwise the attorney - general is competent to decide nonexistence of the crime ... for nonexistence of evidence .

**Seventhly** : (Death Penalty) - sentence should not be allowed except when the crime of the charged person harms the society and threatens them , not threat against a very same person only .

**Eighthly** : Any doubt explains for the interest of a principle obliging judges during continuation of THE sitting and trial .

Yours sincerely  
Mohamed Ali Misurati  
secretary of the General  
People's Committee of  
Justice and Public security

sirte on : 5\3\2004

## حقوق و ضمانات قانونية

- ❖ لا جريمة ولا عقوبة إلا بنص قانوني ساري المفعول .
- ❖ المعني وحده فقط متهم دون غيره ... فلا علاقة لأسرته (زوجته - أطفاله - والده ووالدته وأخوته وأخواته) بجرمه الجنائي ... وسوف تلتحق أسرته بأهله وذويه فور وصولها إلى الجماهيرية مباشرة .
- ❖ المعني سيتم التحقيق معه بحضور محاميه الذي يختاره بمعرفته الشخصية .
- ❖ مدة الحبس الاحتياطي محكمة بنصوص قانونية صارمة ومخالفتها تعرض (المحقق أو المحققين) لأقصى العقوبات .
- ❖ المحاكم جزئية - ابتدائية - استئناف - محكمة عليا .
- ❖ من حق المتهم أثناء حبسه الاحتياطي الاتصال بمحاميه ... وكذلك كافة أفراد أسرته وباللجنة الوطنية لحقوق الإنسان .
- ❖ له أثناء التوقيف حق الإطلاع على كافة المطبوعات والصحف ... والإذاعة المرئية ... والحصول على الرعاية الصحية .
- ❖ مراكز التوقيف والسجون خاضعة مباشرة لإشراف النيابة العامة والنياب العام .
- ❖ لمحامي المتهم أن يتصل بموكله الوقت الذي يريده .
- ❖ من حق المحامي الإطلاع على كافة محاضر التحقيق والاستجواب ... وله حق إيداع أية دواعي براهها ... والمحكمة لها مطلق الحرية في تقدير ووزن تلك الدواعي .
- ❖ أي شك يفسر لمصلحة المتهم قضائياً .
- ❖ يجوز للقاضي النزول بالعقوبة إلى نصف الحد الأدنى الذي يعينه القانون .

24

### Rights and Lawful Guarantees

- ❖ Neither a crime nor a penalty is to be existed without a legal term.
- ❖ The concerned person is only charged nobody else ... no penally against his family (his spouse, his children, his parents, his brothers and sisters ) and his relatives as soon as he directly arrives Jamahiriya .
- ❖ The concerned person will be investigated in the presence of his lawyers chosen by him personally .
- ❖ period of provisional detention is subjected to extreme legal terms and being contrary to them will penalize investigators by high penalties .
- ❖ Courts of jurisdiction, courts of the first instance , courts of appeals and the supreme court .
- ❖ The charged person has the right during his provisional delention to contact his lawyers, his family members as well as the national committee of human rights.
- ❖ During his detention, he has the right to obtain printed matters, newspapers a TV. Channels and health care .
- ❖ Jails and places of detention are directly subjected to the supervision of the Attorney – General.
- ❖ The charged person's lawyer has the right to contact his client at anytime.
- ❖ The lawyer has the right to find out all records and investigations as well as any defences he wants. The court is completely free to assess and weigh those defences .
- ❖ Any suspicion is to be explained for the interest of the charged person.
- ❖ The judge is allowed to reduce penalty to the half of minimum of what the criminal code limits.

U



25

الجمهورية العربية السورية  
وزارة الخارجية  
القسم الثاني

الرقم 46/81  
التاريخ 11/8/1996  
مستند: 34061 الى 34069



الجمهورية العربية السورية  
الاجتهادية السورية  
اللجنة الشعبية العامة  
للإعمال الخارجية والتعاون الدولي

الجمهورية العربية السورية  
وزارة الخارجية  
القسم الثاني

التاريخ 29/8/1996  
الرقم 26/11/1996

مذكرة شفوية

تهدي اللجنة الشعبية العامة للإعمال الخارجية والتعاون الدولي أطيب تحياتها إلى سفارة الجمهورية الإيطالية (مكتب رعاية المصالح البريطانية).

وإذ تشير اللجنة إلى مذكرة رقم 15/8/1 المؤرخة في 9 أيار (مايو) 1997 لفرنسي وإلى مذكرة السفارة رقم 110 المؤرخة في 21 أيار (مايو) 1997 لفرنسي تود الافادة بالآتي بيته :-

(1) سيامي مصطفى الساعدي ، ويكنى (بأبي العنتر) من مواليد طرابلس سنة 1966 لفرنسي ، وهو ابن [REDACTED] ذاتمه الاعترافية طرابلس شارع بن عاشور ، وكان يدرس بشيخ الهندسة .

(2) بعد اختراجه بزعم الزنادقة تنقل بين بريطانيا والسودان والباكستان وبنغلاديش ، وتلقى تدريباته على العمليات الارهابية والتزوير في (بنشاور) بالباكستان وبنغلاديش والسودان ، ويعتبر الآن من قيادات مايسمى "بالجهاد" وينتمي إلى زمرة مايسمى "بالجماعة الاسلامية المقاتلة" ، عضو نشوري ومكلف باللجنة التشريعية ويعتبر المقتس التشريعي للتخطيط .

- دخل السودان باسم سعيد مصطفى الساعدي ، من مواليد طرابلس ، بجواز سفر إيراني رقم [REDACTED]

- غادر الخرطوم إلى بريطانيا بتاريخ 1996/3/17 لفرنسي .

- متزوج من جزائرية ، ويحمل جواز سفر ليبي رقم [REDACTED]

✓

الجمهورية العربية السورية  
وزارة الخارجية  
القسم الثاني



لا يفرط  
بمؤثرات صحية

الرقم الإداري /  
الرقم المسلسل /  
مسائله 3-004 إلى 34009

الجمهورية العربية السورية  
الإدارة العامة  
الوزارة العامة  
للإتصال الخارجى والتعاون الخارجى

التاريخ /  
الوقت /

(3) أجرت معه نشرة نصف شهرية تسمى (الحسام) تصدر عن مكتب الخدمات فى (بوسطن) بالولايات المتحدة الأمريكية العدد الثالث المؤرخ فى 1995/9/22 أفرنجى المرفق طيه (4 صفحات) ، مقابلة أوضح فيها :-

انه أحد أعضاء قيادة العمل الإسلامى فى ليبيا (الجماعة الإسلامية المقاتلة) وأشاد بطلان "الجهاد" التى بدأت "تزعج" حسب تعبيره على أرض الجزائر - مصر - ليبيا - فلسطين .

أن الأحداث التى جرت على أرض ليبيا من أعتيالات كانت تتلجا لعمل تنظيمى استغرق بضعة سنوات من التخطيط والتنظيم وبث الدعوة الجهادية السلفية بين الشباب فى ليبيا .

(4) وتحت عنوان (خطوط عرضة فى منهج الجماعة الإسلامية المقاتلة) كتب عدة حلقات فى نشرة (النجر) أفتى فى الحلقة الأخيرة منها المنشورة فى العدد 23 السنة الثالثة 1997 أفرنجى المرفقة طيه (3 صفحات) بوجوب مقاتلة الحكام ، وطلب من أتباعه فى ليبيا أن يحملوا السلاح ويستعينوا بربهم على مجادلة أعداء الله .

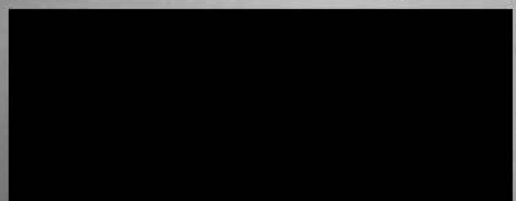

(6) بعد والعنة ليرك الشاطلى مسدر بيان يحمل رقم 8 بتاريخ 1996/12/31 أفرنجى نشر فى العدد 23 السنة الثالثة 1997 أفرنجى فى نشرة الفجر المرفقة طيه (صحتين) ذكر بأن منذ العطية هو وأشار الى أداء وطريقة التنفيذ ، واتيان موضع باسم أبو عبد الله المسادق (أمير الجماعة الإسلامية المقاتلة) واسمه الحقيقى ساسى مصطفى الساعدى ويطلق على نفسه أبو المنذر الساعدى .



27

الجمهورية العربية السورية  
وزارة الخارجية  
القسم الثاني



الجمهورية الإيطالية  
وزارة الخارجية  
القسم الثاني

الرقم الإشاري / .....  
المراسلات / .....  
مخاطب 34061 إلى 34069

الجمهورية العربية السورية  
الإستراتيجية الوطنية  
اللجنة الشعبية العامة  
للأعمال الخارجية والتعاون الدولي

التاريخ / .....  
الموافق / 19.....م

وإذ تحيط اللجنة الشعبية العامة للاتصال الخارجي والتعاون الدولي  
سفارة الجمهورية الإيطالية (مكتب رعاية المصالح البريطانية) علما بما تقدم  
بناءا على طلبها تؤكد بأن إيواء المملكة المتحدة لهذا العنصر الارهابي وغيره  
من العناصر والمجموعات الارهابية وتمكينها من الاعلان صراحة عن  
نواياها الهدامة وإصدار البيانات عن خطتها ونشاطاتها الارهابية التخريبية  
ضد دولة عضو في الامم المتحدة تتاهض الارهاب وتلتزم بما اتفق عليه  
المجتمع الدولي وتتعاون معه ومع جيرانها في مكافحة عناصره يتنافى مع  
قرارات الامم المتحدة ويعتبر انتهاكا لمبادئ القانون الدولي وخروجاً عن  
الاعراف والمواثيق الدولية .

واللجنة الشعبية العامة للاتصال الخارجي والتعاون الدولي إذ تكرر  
استنكارها لما تقدم ، ترحو من سفارة الجمهورية الإيطالية (مكتب رعاية  
المصالح البريطانية) إحاطة حكومة بلادها بنص هذه المذكرة ودعوتها الى  
اتخاذ الاجراءات العاجلة والكفيلة بتسليم تلك العناصر ووضع حد لمثل هذه  
التصرفات في المستقبل حتى تثبت أنها " تراقب بجديّة واهتمام كل ادعاءات  
الارهابيين ونشاطاتهم في المملكة المتحدة وتقاوم وتدين الارهاب .

تعنت اللجنة الشعبية العامة للاتصال الخارجي والتعاون الدولي هذه  
المناسبة لتجدد لسفارة الجمهورية الإيطالية (مكتب رعاية المصالح  
البريطانية) التعبير عن فائق التقدير والاحترام



السفارة الجمهورية الإيطالية (مكتب رعاية المصالح  
البريطانية) - طرابلس  
التاريخ : 1997/5/6 فرنسي  
493

U

28

**THE Great Socialist People's Libyan  
Arab Jamahiriya  
The General People's Committee of Foreign  
liaison and international Collaboration**

**Warrant**

The General people's Committee of Foreign Liaison and International Cooperation presents its best regards to the Embassy of the Republic of Italy (Bureau of the Italian Interest Providence)

Meanwhile the committee mentions its warrant number 1/8/15 dated on January 9, 1997 and the warrant of the Embassy number 110 dated on January 21, 1997, the General People's Committee of Foreign Liaison and International Collaboration

Would like to inform the following:

1 - Sami Mostafa Assaadi, his alias is (abu-almundir) born in Tripoli in 1996.

Son of [REDACTED], his normal residence is in Tripoli, Ben Ashur Street, He was a student at faculty of engineering.

2 - Having joined the extremist faction, he moved among UK, the Sudan, Pakistan, and Afghanistan, He received his training on terrorist operations and forgery in Peshawar, Pakistan, Afghanistan and the Sudan.

Currently he is considered a leader of what so called "AL-Jihad" and affiliated to what -so called "The Libyan Islamic Fighting Group". He is a consultative member of the committee. He is considered the Legislative Mufti of the organization.

29

- He entered the Sudan in the name of Said Mostafa Assaadi born in Tripoli bearing an Iranian passport [REDACTED]
- He left khartoum on his way to UK on March 17, 1996.
- He is married to an Algerian woman and bearing a Libyan passport [REDACTED]
- A semimonthly magazine interviewed him called " Al-Husam" issued on behalf of Washing Bureau Service , USA volume (3) ( enclosed 4 pages) and stated saying :
- He is a member of the Islamic leadership in Libya i.e. the Libyan Islamic Fighting Group (LIFG). He appealed the pioneers of Al-jihad that started growling on the territories of Algeria, Egypt, Libya and Palestine according to his statement.
- Incidents which took place on the Libyan territory of the arrests, were consequences of organizational activity took several years of planning and organizing and spreading Salafist Al-jihad call among Libyan youngsters.
- 4 - Under the title of " Broad Lines) in (LIFG's) programme , He wrote numerous editions in the Dawn bulletin gave a religious opinion in the latest edition published in volume 22 year (3) 1997 .enclosed by three pages obliging to assassinate rulers . He ordered his followers in Libya to be armed and helped by god to fight god's foes.

[REDACTED]



30

6 - After the incidents in Al-Shati , a statement number 8 dated on December 31, 1996 was issued and published in volume 23 year (3) 1997 in the Dawn bulletin enclosed (two pages) Said that who implementer of the operation was [REDACTED]

[REDACTED]. He indicated the tool and the way of implementing the statement signed in the name Abdullah Sadeq (Emir of the Group) i.e LIFG. His real name is Sami Mostafa Assaadi.

Whose alias is Abu-Mundir Assaadi.

The General People's Committee of foreign Liaison and international Cooperation informs the Embassy of the republic of Italy (Bureau of the Italian interest providence) about what is above that on basis of its request, it assure that UK lodging this terrorist element and others of such elements and terrorist groups and enabling to state explicitly about its destructive intention and issuing communiqués about its plans and terrorist destructive activities against a member state to the United Nation organization confronting terrorism committing what was agreed upon by the international community in cooperation with them and its neighbours to fight its elements contradicted to the UN resolutions and being considered a breach to the rules of the international law and dissent from international customs and charters .

Meanwhile the General People's Committee of the foreign liaison and international cooperation repeats its condemnation for what was above. It request the Embassy of the Republic of Italy (Bureau of the British Interest Providence) to inform its government this warrant calling it for taking urgent action to extradite those elements putting an end to such acts in future in

31

order to prove that it seriously carefully controls all terrorists claims and their activities in UK resists and condemns terrorism .

The General People's Committee of Foreign Liaison and International Cooperation takes this occasion to reassure the Embassy of the Republic of Italy (Bureau of the British Interest providence " to express its esteem and consideration.

**To: the Embassy of the Republic of Italy (Bureau of the British Interest providence). Tripoli**

**Date: June .6.1997**

✓





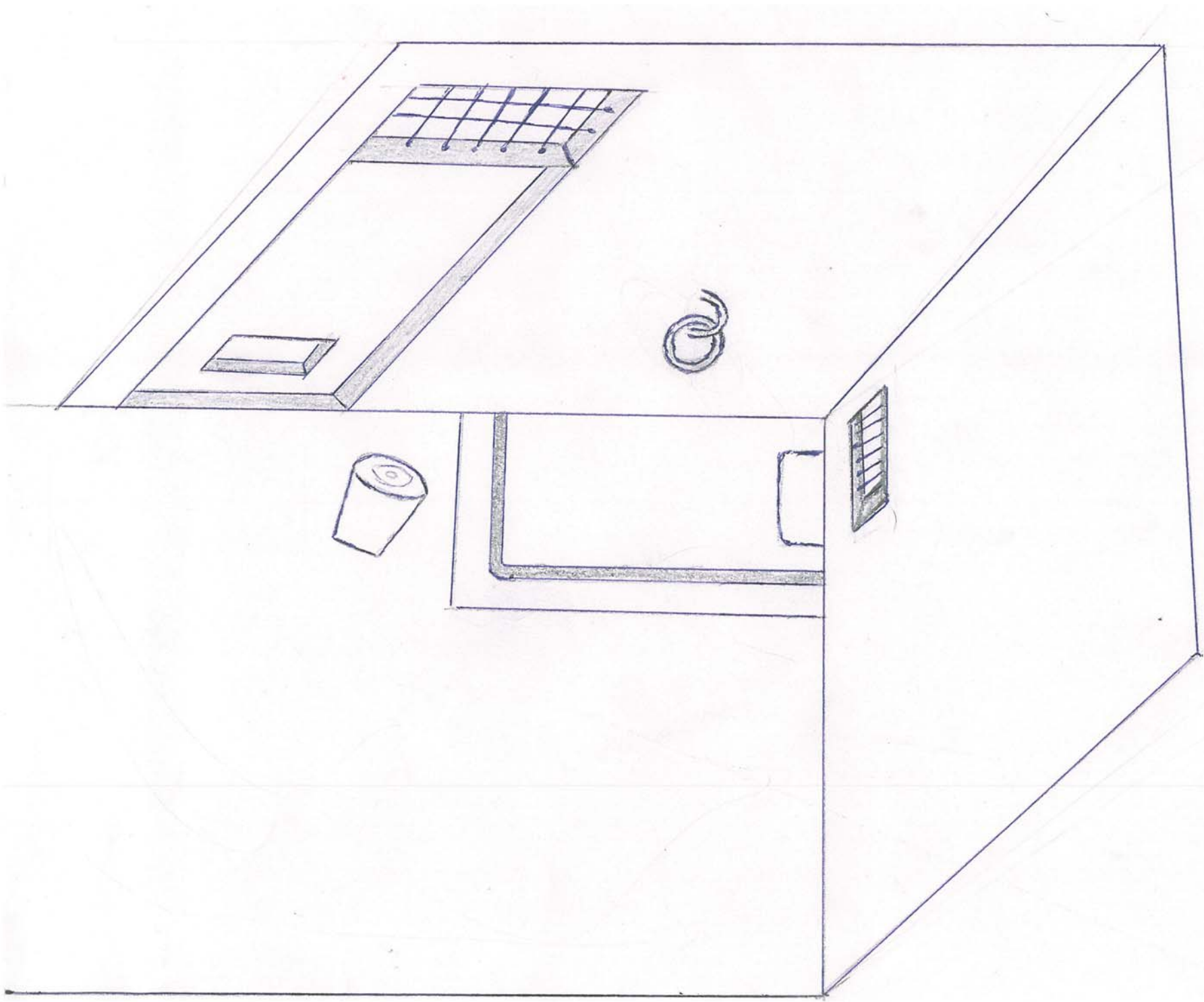

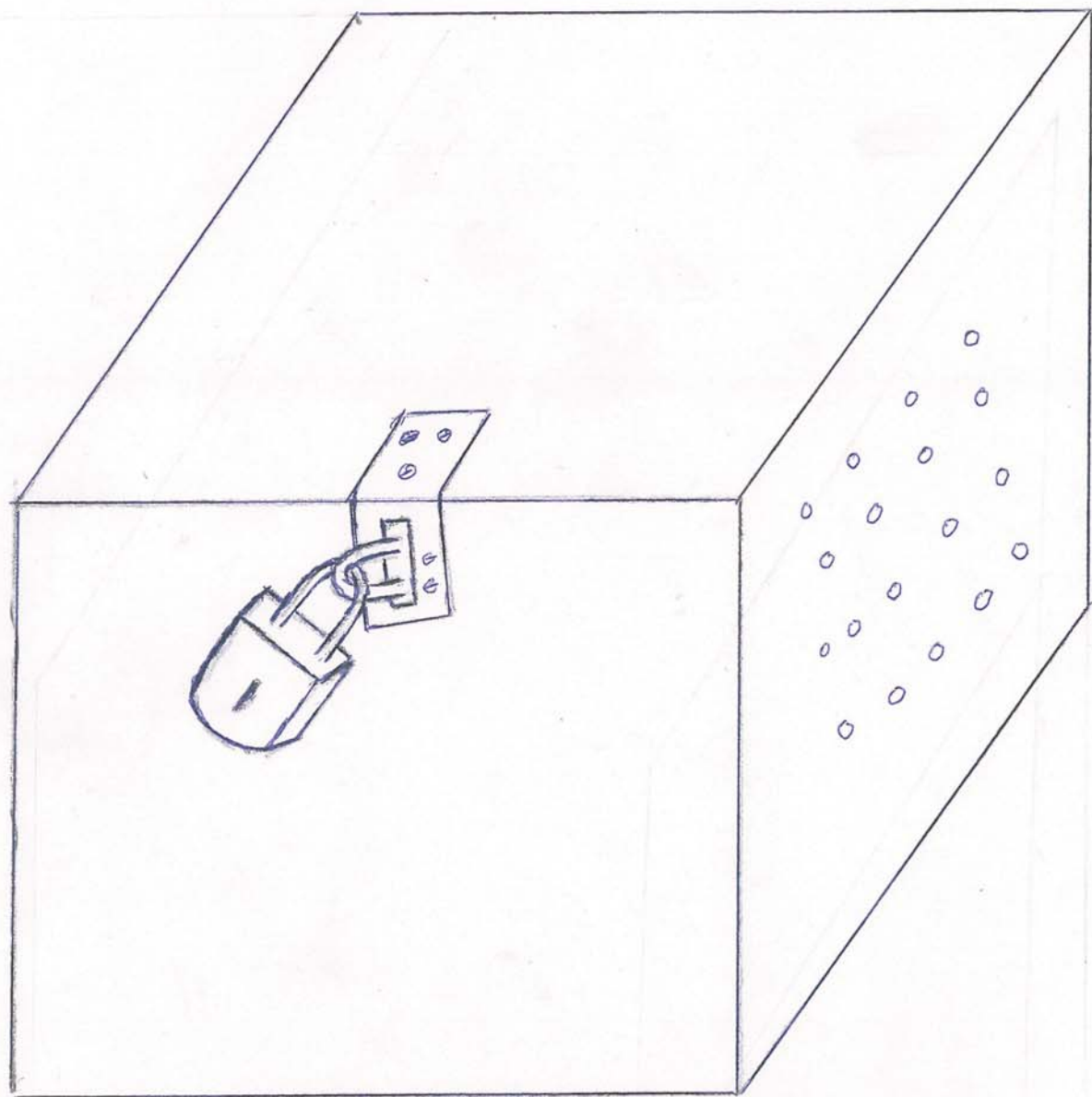



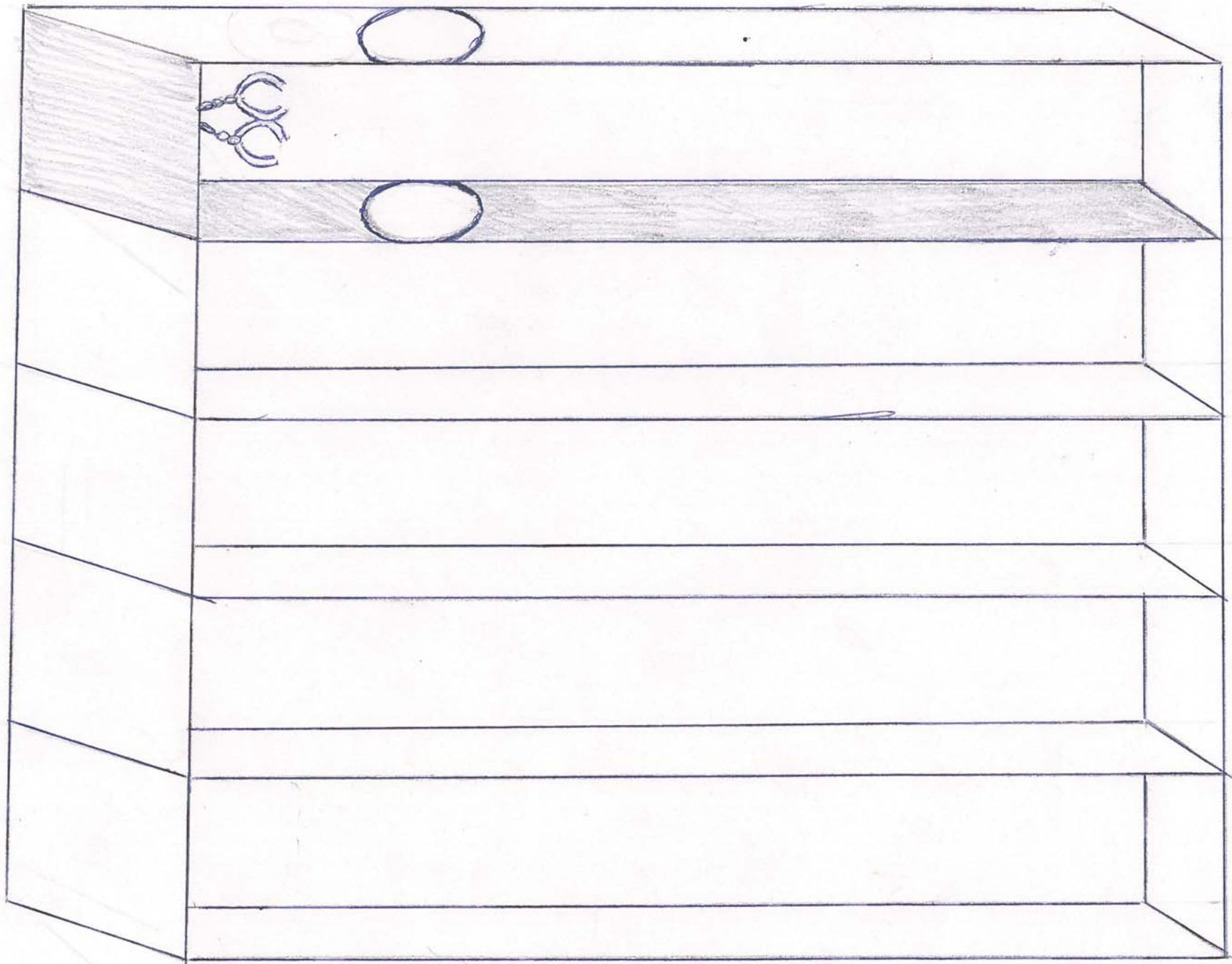

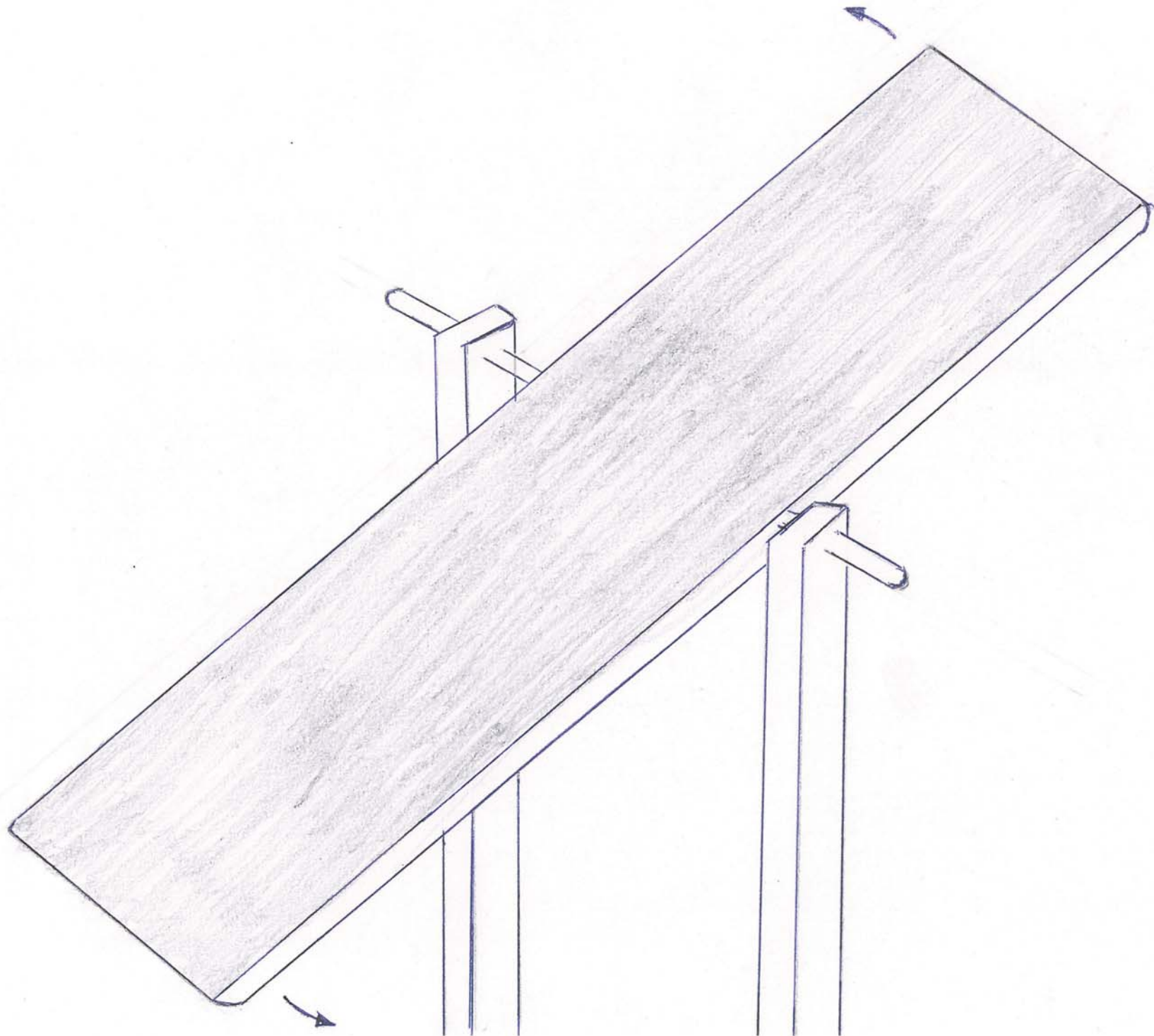

# Delivered Into Enemy Hands

## US-Led Abuse and Rendition of Opponents to Gaddafi's Libya

When rebel forces overtook Tripoli in August 2011, prison doors were opened and office files exposed, revealing startling new information about Libya's relations with other countries. One such revelation, documented in this report, is the degree of involvement of the United States government under the Bush administration in the arrest of opponents of the former Libyan leader, Muammar Gaddafi, their subsequent torture and other ill-treatment in US custody, and their forced rendition to Libya.

*Delivered into Enemy Hands: US-Led Abuse and Rendition of Opponents to Gaddafi's Libya* is based on Human Rights Watch interviews with more than a dozen former members of an anti-Gaddafi Libyan Islamist group who, after September 11, 2001, were swept up in the Middle East, Africa, and Asia and sent back to Libya, mostly between 2004 and 2006. At the time, the United States and the United Kingdom were trying to transform Gaddafi from foe to ally.

The report also documents allegations of torture and other serious ill-treatment committed by US personnel in US secret detention sites in Afghanistan. These include a newly reported case of waterboarding and another case of similar water torture. The report also details the mistreatment of these men back in Libya, where they endured solitary confinement, other abuses, and long prison sentences following unfair trials.

Human Rights Watch calls on the US, the UK, and other governments involved in these renditions to investigate the alleged abuses. The US should provide a full accounting of its extensive secret detention program, enable victims to obtain redress, and prosecute those responsible for authorizing the mistreatment.



*A file folder found after the fall of Tripoli in a building belonging to the Libyan external security services containing faxes and memos between the US Central Intelligence Agency (CIA) and the Libyan Intelligence Service.*

© 2011 Tim Gucza