

# **ACCESSIBILITY GUIDE**

**OCTOBER 2020**

**INTERNATIONAL PARALYMPIC COMMITTEE**

# TABLE OF CONTENTS

FIGURES AND TABLES .....	8
Foreword.....	10
Introduction .....	10
Evolving content.....	10
Disclosure .....	11
Structure and content of the IPC Accessibility Guide .....	11
Content.....	11
Executive summary .....	12
Aim and purpose of the Guide.....	12
Key objectives of the Guide .....	12
Target audience of the Guide .....	12
1 General information and background .....	15
1.1 Background information .....	15
1.1.1 Access as a human right .....	15
1.1.2 United Nations (UN) Convention on the Rights of Persons with Disability 15	
1.1.3 Inclusion and global impact.....	16
1.2 Fundamental Principles for Accessibility .....	16
1.2.1 Equity .....	16
1.2.2 Dignity.....	16
1.2.3 Functionality .....	17
1.3 Beneficiaries of an accessible and inclusive environment .....	17
1.3.1 People who use a wheelchair.....	17
1.3.2 People who have reduced mobility .....	18
1.3.3 People who have a vision impairment.....	18
1.3.4 People Who Are deaf or hard of hearing .....	18
1.3.5 People who have a cognitive impairment .....	18
1.3.6 Other beneficiaries .....	18
1.4 Measurements and conversions.....	20
1.5 Key concepts and notions on accessibility.....	21
1.6 Glossary.....	22
2 Quick reference guide.....	27

2.1	Key measurement reference table .....	27
2.2	Event accessibility checklist .....	35
3	Venues interior elements requirements .....	42
3.1	Introduction.....	42
3.2	Doors, doorways, and gates.....	42
3.2.1	Entrances and exits .....	42
3.2.2	Entrance design .....	42
3.2.3	Clear width .....	43
3.2.4	Power operated doors.....	45
3.2.5	Non-power-operated doors .....	46
3.2.6	Manoeuvring space at doors .....	47
3.2.7	Gates and turnstiles .....	47
3.2.8	Manually operated sliding doors.....	48
3.3	Floor surfaces .....	49
3.3.1	Material.....	49
3.4	Clear floor space .....	50
3.4.1	Turning space for wheelchairs.....	50
3.4.2	Protruding Objects.....	51
3.5	Reach range, knee and toe clearance .....	51
3.5.1	Reach ranges.....	52
3.5.2	Table and counters.....	54
3.6	Venue accessible seating .....	54
3.6.1	Spectator accessible seating .....	55
3.6.2	Sight lines.....	56
3.6.3	Accessible spaces .....	57
3.7	Emergency provisions .....	58
3.7.1	Emergency evacuation .....	58
3.7.2	Areas of rescue assistance.....	58
3.7.3	Alarms.....	59
3.7.4	First aid rooms.....	59
3.7.5	Building evacuation instructions .....	59
3.7.6	Other requirements.....	59
3.7.7	Event considerations.....	60
4	All accessible routes .....	62

4.1	Introduction.....	62
4.2	Pathways .....	62
4.2.1	Pathways rest areas.....	63
4.2.2	Waiting and queuing areas .....	64
4.3	Walking surfaces and protruding objects.....	64
4.3.1	Protruding Objects.....	64
4.3.2	Exterior pavements and features.....	66
4.4	Ramp .....	67
4.4.1	Slope.....	67
4.4.2	Landings.....	70
4.4.3	Handrails.....	70
4.5	Kerb ramps .....	71
4.5.1	Pathways adjacent to a kerb ramp.....	75
4.6	Stairs, moving walkways and escalators.....	76
4.6.1	Stairs.....	76
4.6.2	Nosing.....	77
4.6.3	Detectable warnings .....	77
4.6.4	Moving walkways and escalators .....	78
4.7	Elevators .....	78
4.7.1	Elevator doors .....	78
4.7.2	Elevator car .....	79
4.7.3	Elevator controls.....	80
4.7.4	Other requirements and considerations .....	81
4.8	Transport load zone.....	82
4.9	Signage wayfinding and public spaces .....	82
4.9.1	Sequencing information .....	83
4.9.2	Placement and decision points.....	84
4.9.3	Kiosks and maps.....	86
4.9.4	Pictograms and icons.....	88
4.9.5	Audible cues - beacons.....	89
4.9.6	Tactile cues .....	90
4.9.7	Surfaces.....	91
4.9.8	Sign conventions.....	92
4.9.9	Directional lighting.....	95

4.10	Evacuation routes .....	95
4.10.1	Emergency evacuation .....	95
4.10.2	Areas of rescue assistance.....	95
5	Washrooms and other plumbing elements .....	98
5.1	Introduction.....	98
5.2	Drinking fountain.....	98
5.3	Toilet compartment and cubicles.....	98
5.3.1	Toilet and urinals.....	99
5.3.2	Grab bars.....	100
5.3.3	Lavatories and sinks.....	101
5.3.4	Shower and water closet .....	102
5.4	Shower and tub.....	104
5.4.1	Shower .....	105
5.4.2	Tub .....	106
5.5	Locker rooms.....	107
5.5.1	Locker design.....	108
5.5.2	Private changing space.....	108
5.5.3	Common shower space .....	109
5.6	Laundry room .....	109
5.6.1	Washer and dryer .....	109
6	The city.....	112
6.1	Introduction.....	112
6.2	Transportation .....	112
6.2.1	Road Transportation.....	112
6.2.2	Rail transportation.....	115
6.2.3	Maritime transportation.....	117
6.3	Parking.....	120
6.3.1	Parking area requirements.....	120
6.3.2	Signage for accessible parking.....	121
6.3.3	Valet parking.....	122
6.4	Airports.....	122
6.4.1	Pre-flight information.....	123
6.4.2	Check-in and mobility equipment carriage.....	123
6.4.3	Moving through the airport.....	124

6.4.4	Boarding the aircraft.....	124
6.4.5	Disembarkation of the aircraft and arrivals .....	125
6.5	Public services .....	125
6.5.1	City parks and outdoor recreational areas.....	125
6.5.2	Retail and food and beverage outlets .....	126
6.6	Hotel.....	127
6.6.1	Accessible amenities .....	128
6.6.2	Accessible room.....	130
6.6.3	'Wheelchair friendly' guest room.....	137
7	Olympic and Paralympic Games Specific Guidelines.....	141
7.1	Introduction.....	141
7.1.1	Working for accessibility.....	141
7.1.2	Inclusive spaces .....	141
7.1.3	Temporary Structure vs Permanent Structure.....	142
7.2	Creating an Accessible and Inclusive Olympic and Paralympic Games.....	142
7.2.1	Strategic and Operational Approach.....	143
7.2.2	Technical Approach.....	143
7.2.3	Organisational Approach.....	143
7.2.4	Commitment to a consistent consultation process.....	144
7.3	Staff Awareness and Training.....	144
7.3.1	Training Themes .....	145
7.4	Games Infrastructure.....	148
7.4.1	Competition Venues .....	148
7.4.2	Olympic and Paralympic Villages.....	157
7.4.3	Non-competition Venues .....	162
7.5	Functional Areas Considerations on Operations .....	170
7.5.1	Accommodation.....	170
7.5.2	Accreditation .....	172
7.5.3	Arrivals and Departures .....	173
7.5.4	Brand, Identity and Look of the Games.....	175
7.5.5	Broadcasting .....	175
7.5.6	Ceremonies (Opening and Closing).....	176
7.5.7	Ceremonies (Victory Ceremonies and Sport Presentation) .....	179
7.5.8	City Operations.....	180

7.5.9	Cleaning and Waste (and Snow Removal).....	181
7.5.10	Communications .....	182
7.5.11	Doping Control.....	183
7.5.12	Event Services.....	184
7.5.13	Food and Beverage Services .....	185
7.5.14	Licensing - Merchandising - Retail Operations.....	187
7.5.15	Medical Services .....	187
7.5.16	NOC/NPC Services .....	188
7.5.17	Olympic and Paralympic Family and Dignitary Services .....	189
7.5.18	People Management.....	191
7.5.19	Press Operations .....	193
7.5.20	Rate Card .....	195
7.5.21	Risk Management .....	195
7.5.22	Security .....	196
7.5.23	Sport.....	197
7.5.24	Technology .....	198
7.5.25	Ticketing.....	200
7.5.26	Torch Relay .....	201
7.5.27	Transport .....	203
7.5.28	Venue Management.....	205
7.5.29	Venues and Infrastructure .....	206
7.5.30	Village Operations.....	207
7.6	Mobility Services (or Games Mobility).....	209
7.6.1	Objective.....	209
7.6.2	Potential Service Users .....	209
7.6.3	Scope of Services.....	209
7.6.4	Staff .....	211
7.6.5	Equipment.....	211
7.6.6	Location and Parking.....	212
7.6.7	Accreditation .....	212
8	Reference Material.....	215

## FIGURES AND TABLES

Figure 1: Measurement and graphics standard .....	20
Figure 2: Clear door opening .....	43
Figure 3: Door clearances between a series of doors .....	44
Figure 4: Push button at door .....	45
Figure 5: Push away door .....	46
Figure 6: Door operating mechanism.....	46
Figure 7: Gates and turnstile.....	48
Figure 8: Glass door visual .....	49
Figure 9: Floor transition details.....	50
Figure 10: Turning space clearances.....	51
Figure 11: Side and front approach .....	52
Figure 12: Reach ranges .....	53
Figure 13: Service counter dimensions .....	54
Figure 14: Pathway widths .....	63
Figure 15: Protruding objects.....	65
Figure 16: Headroom.....	66
Figure 17: Ramps and sloped surfaces .....	68
Figure 18: Ramp slope and cross slope .....	69
Figure 19: Handrail cross section .....	71
Figure 20: Raised marked crossing.....	72
Figure 21: Kerb ramp at mid-block.....	72
Figure 22: Kerb ramp at corner .....	73
Figure 23: Dual compound kerb ramp at corner.....	73
Figure 24: Single compound kerb ramp at corner.....	74
Figure 25: Diagonal kerb ramps .....	74
Figure 26: Diagonal kerb ramps .....	75
Figure 27: Technology at pedestrian crossings.....	76
Figure 28: Stair dimensions .....	77
Figure 29: Elevator interior plan .....	80
Figure 30: Elevator control panel.....	81
Figure 31: Modified international symbol of access.....	84
Figure 32: Example of a landmark .....	86
Figure 33: Detailed map kiosk.....	87
Figure 34: Example of pictograms .....	88
Figure 35: Common international pictograms.....	88
Figure 36: Using beacon technology.....	90
Figure 37: Example of a tactile map.....	91
Figure 38:Tactile surfaces.....	92
Figure 39: Using directional arrows with pictograms.....	93
Figure 40: Accessible urinals .....	100



Figure 41: Temporary grab bar .....	101
Figure 42: Bathroom fixtures schematic .....	103
Figure 43: Portable shower chair .....	105
Figure 44: Wall mounted shower chair .....	105
Figure 45: Locker interior elevation .....	108
Figure 46: Washing and drying machines.....	110
Figure 47: Van ramp dimensions .....	113
Figure 48: Parking spaces and access aisle .....	121
Figure 49: Passenger loading zone with alternate kerb cut locations.....	122
Figure 50: Accessible King Room floor plan .....	134
Figure 51: Accessible King Room 3D layout.....	134
Figure 52: Accessible Queen Room floor plan.....	135
Figure 53: Accessible Queen Room 3D layout.....	136
Figure 54: Accessible hotel bathroom 3D layout .....	136
Figure 55: Accessible hotel bathroom features .....	137
Figure 56: 'Wheelchair friendly' bathroom.....	139
Table 1: Space requirements in door spaces .....	47
Table 2: Calculation spectator accessible seating.....	55
Table 3: Examples of spectator accessible seating numbers based on venue size .....	55
Table 4: Maximum allowable slope of ramps.....	67
Table 5: Symbol sizes in signage.....	89
Table 6: Letter sizes in signage .....	94
Table 7: Bathroom fixtures measurements .....	104
Table 8: Calculation spectator accessible seating .....	153
Table 9: Spectator accessible seating at the Olympic and Paralympic Games .....	154

# FOREWORD

## INTRODUCTION

This Guide is part of the International Olympic Committee (IOC) and International Paralympic Committee (IPC) guiding documentation. The Guide is designed to assist Organising Committees (OCOGs) and host city authorities in the successful planning and delivery of the Olympic and Paralympic Games.

Furthermore, this Guide can be used by a wider audience outside the Games context, to assist organisations in creating a more accessible and inclusive environment.

The Guide draws on experience from previous OCOGs, industry experts, legislation and design standards. It contains a combination of supporting information, guidelines, recommendations and previous Games examples to help OCOGs and their delivery partners deliver a truly inclusive Games for all stakeholders.

At present, legislation, design standards and practices about accessibility vary significantly around the world, even among countries with well-developed related policies and legislation. These variations produce uncertainty as to which are the 'internationally accepted' standards. This results in further delays to a country and/or region's willingness to adopt equivalent design standards and practices for accessibility, because they hesitate to adopt anything except a generally accepted international model.

It is for that reason that while developing this Guide the IPC attempted to incorporate information from around the world, assess and rationalise the differences, and form a set of design standards and practices that will have the potential to become 'internationally accepted' through the visibility of the Games.

This Guide does not contain any contractual obligations on the part of OCOGs, as those are set out in the Host City Contract - Principles (HCC - Principles) and Host City Contract - Operational Requirements (HCC - Operational Requirements).

## EVOLVING CONTENT

Each edition of the Olympic Games and Paralympic Games brings innovation, responding to the context of the host city and host country and reflecting changing global trends. The Olympic Games Guides (OGGs) and IPC Guides will therefore also evolve as part of the evaluation process that follows each Games' edition.

The IOC and IPC will ensure that the latest evolutions in Games organisation are reflected in future OGG and IPC Guides editions. These future editions will be published according to a "Publication Roadmap" provided to stakeholders on a regular basis.

## **DISCLOSURE**

The material and the information contained herein are provided by the IPC for the primary purpose of organising and staging an edition of the Olympic and Paralympic Games, but can also be used as a global reference on accessibility. This material and information is the property of the IPC and its use or reproduction, in whole or in part, requires prior notification or written approval of the IPC.

## **STRUCTURE AND CONTENT OF THE IPC ACCESSIBILITY GUIDE**

The structure of the Guide covers three general areas:

- General information and quick reference guide (Chapters 1-2);
- Technical specifications (Chapters 3-6); and
- Games-specific guidance related to organising the Olympic and Paralympic Games (Chapter 7).

Chapters 1-6 cover concepts that can relate to a wider audience outside of a Games context, while Chapter 7 discusses topics specific to the planning and delivery of the Olympic and Paralympic Games.

## **CONTENT**

The directions and recommendations contained in the Guide draw from different sources, such as existing guides and manuals, national building codes, advice from accessibility experts, and information gathered from experiences and lessons learned from previous Games.

In some of the topics and technical standards, **Exceptions** are included; the term refers to conditions that require a different approach due to a specific situation, such as landscape limitations or pre-existing restrictions. **Exceptions** for elements related to the Paralympic Games should be discussed with the IPC on a case-by-case basis to ensure the best solution can be implemented.

# **EXECUTIVE SUMMARY**

## **AIM AND PURPOSE OF THE GUIDE**

This Guide aims to facilitate the full participation of all stakeholders in the Games and legacy planning, through a commitment to accessibility and inclusion, as well as be a useful reference for any of its users.

It is primarily intended to serve as a resource to OCOG staff, government authorities, private entities and any other organisation associated with the Olympic and Paralympic Games - especially for those entrusted with the responsibility to design, equip, and operate facilities and deliver services for the Games. This purpose drives all concepts, references, guidelines and solutions proposed.

The Guide provides directions for accessible design solutions and applications, but it does not limit the possibility for the host city and host country authorities to further improve such applications and solutions to facilitate an inclusive environment in the long term.

## **KEY OBJECTIVES OF THE GUIDE**

Based on the above aim and purpose, the key objectives of the Guide are to:

1. Ensure delivery of a comparable and high quality 'Games experience' for all stakeholder groups;
2. Promote high standards of what can be achieved in terms of an accessible and inclusive Games environment;
3. Create a set of standards on accessibility and inclusion which shall act as a 'benchmark' for the host community; and
4. Define a scope and vision by which accessibility can be planned to create a sustainable legacy long after the Games have finished.

## **TARGET AUDIENCE OF THE GUIDE**

As with all other guides developed by the IOC and the IPC, this Guide is primarily developed to assist the OCOG and host city authorities to plan for and organise the Olympic Games and Paralympic Games.

Although the Guide applies to both those Games, it should be noted that the number of persons with disabilities within some of the stakeholder groups participating in the Paralympic Games makes responding to their accessibility needs a significant challenge for Games organisers. In this view, the Guide aims to assist the OCOG, the host city authorities and their partners, and other government authorities to understand the needs and then design from a very early stage a barrier-free environment for all participants, according to their Games-related needs, driven by the scope of accessibility required at the Paralympic Games.

The Guide also targets an audience beyond the Games context, as besides the OCOGs and cities bidding to host the Games, it is also intended for use by governments, local and regional authorities, businesses, tourism organisations and other similar entities.

# **CHAPTER 1**

## **GENERAL INFORMATION AND BACKGROUND**



# **1 GENERAL INFORMATION AND BACKGROUND**

## **1.1 BACKGROUND INFORMATION**

The vision of the International Paralympic Committee (IPC) is to “make for an inclusive world through Para sport”. Through a process of continuous organisational improvement, the IPC strives to create an inclusive and equitable environment in which all persons and groups are respected, welcomed and supported.

As the owner of one of the biggest sporting events in the world, the IPC recognises its responsibility to create a platform not only for sporting excellence, but to also promote the creation of truly inclusive societies with fully-accessible environments and to embrace the capabilities of persons with disabilities.

Therefore, the IPC’s strategy goes beyond Games’-related infrastructure and seeks to encourage positive cultural change. The principles, solutions, and practices used to make the host city and all Games-related infrastructure and services accessible will create a culture of inclusion, in a just and equitable manner, which will then influence and change in the long term the way public facilities and services are designed, operated, and delivered.

### **1.1.1 ACCESS AS A HUMAN RIGHT**

Access is a basic human right and a fundamental pillar of social justice. Social justice is about the acceptance of people as individuals and about access to fair and equal opportunity to participate fully in social interaction. A truly accessible environment is one where all people can freely express their independence, and where any impediment to integration is removed.

### **1.1.2 UNITED NATIONS (UN) CONVENTION ON THE RIGHTS OF PERSONS WITH DISABILITY**

The UN Convention on the Rights of Persons with Disabilities and its Optional Protocol was adopted on 13 December 2006. Since then, the Convention forms an international regulatory basis as more and more countries become signatories.

The concept of universal accessibility is a fundamental aspect of the Convention. The Convention requires countries to identify and eliminate obstacles and barriers, and ensure that persons with disabilities can access their environment, transportation, public facilities and services, and information and communications technologies.

### **1.1.3 INCLUSION AND GLOBAL IMPACT**

Inclusion emphasises design of physical structures that eliminate barriers to ease movement for persons with disabilities. The notion of inclusion is central to the aspiration of the Paralympic Movement towards a better society.

According to the IPC Diversity and Inclusion Policy, *“Diversity is a reality. Inclusion is a choice. The IPC chooses to lead on this issue because only by accounting for and benefitting from difference will we continue to grow and sustain the Paralympic Movement.”*

However, true inclusion in social life is not possible without access.

## **1.2 FUNDAMENTAL PRINCIPLES FOR ACCESSIBILITY**

Full access to the Games experience is paramount for all stakeholders of the Olympic Games and Paralympic Games. For this to occur, all venue design and planning, as well as Games’ operations, need to be carried out in an inclusive way to everybody - regardless of any individual limitations.

With this in mind, three fundamental principles underlie this Guide and provide the basis for the design of facilities and operational planning for the Olympic Games and Paralympic Games.

All three principles need to be satisfied for a facility or a service to be considered accessible. The three principles are: equity, dignity and functionality.

### **1.2.1 EQUITY**

Ensure that all people, regardless of their functional capacity, receive the same experience or level of service.

For this, the design and operating plans should provide the same experience of use for all constituents. Segregation of any user or user group must be avoided. Provisions for privacy, security, and safety should be equally available to all.

### **1.2.2 DIGNITY**

Ensure the way in which a facility is operated, or a service is provided, maintains the status and respect of any person using it.

For this, the facilities’ design and operating plans should be able to accommodate a wide range of individual preferences and abilities. Each person must be able to choose their preferred method of use, and at their own pace. Furthermore, the use of a service that is publicly provided needs to be easy to understand, regardless of the user's experience, knowledge, language skills, current concentration level or physical



condition. Accessible design should eliminate unnecessary complexity and allow for intuitive and simple use.

### **1.2.3 FUNCTIONALITY**

Ensure the service or facility provides for its purpose, meeting the specific needs of every constituent group it is intended for, regardless of any functional limitations.

For this, the design and operating plans need to:

- Communicate necessary information effectively to the user, regardless of the level of any user's sensory abilities. A variety of different modes for the presentation of essential information should be used.
- Minimise hazards and the adverse consequences of accidental or unintended actions. Consequences of misuse should be minimal. Elements that are potentially hazardous should be eliminated or isolated.
- Allow efficient and comfortable use with a minimum of fatigue and/or with using reasonable operating force.
- Provide appropriate size and space to make approach, reach, manipulation and use comfortable to all users, regardless of body size, posture or mobility.

## **1.3 BENEFICIARIES OF AN ACCESSIBLE AND INCLUSIVE ENVIRONMENT**

Why does accessibility matter? Contrary to the assumption that it is only relevant to people with permanent and discernible disabilities, research has shown the actual percentage of people who require accessible infrastructures and services may reach 20% of the population at any given time.

The population who can take advantage of accessible infrastructures and services is made up of people with a wide range of needs, all of whom can be beneficiaries of an accessible and inclusive environment. The main categories are:

### **1.3.1 PEOPLE WHO USE A WHEELCHAIR**

About 0.6 % of the global population use a wheelchair on a permanent or frequent basis because walking is either difficult or impossible for them. This figure is higher for the elderly. Conventional design that does not embrace the needs of wheelchair users can have a negative impact on this group. However, providing "universal accessible" transport, pathways, entrances and circulation spaces assists people with various mobility impairments as well as those who use wheelchairs.

### **1.3.2 PEOPLE WHO HAVE REDUCED MOBILITY**

This group is made up of those often referred to as people with reduced mobility - for example, those who can walk but require walking aids or those who have difficulty walking long distances. This group benefits from design that cuts down travelling distances or the need to stand for long periods.

### **1.3.3 PEOPLE WHO HAVE A VISION IMPAIRMENT**

This group includes people who are totally or legally blind, as well as people with vision impairments that may have some sight. These individuals benefit from clear pathways and wayfinding signage, alternative formats for printed information such as Braille, large print or audio recordings, as well as tactile surfaces, colour contrasts, and non-reflective surfaces.

### **1.3.4 PEOPLE WHO ARE DEAF OR HARD OF HEARING**

This group includes people who are deaf (i.e. cannot hear at a functional level and often use sign language or lip reading to communicate). People in this group benefit from written information and from using assistive hearing devices such as hearing aids, induction loop systems and passive infra-red systems.

### **1.3.5 PEOPLE WHO HAVE A COGNITIVE IMPAIRMENT**

This group of people benefits from a flexible approach to service provision, documents written in plain language, and logical internal layouts at venues. In addition, staff and volunteer training needs to focus on their needs, particularly in connection with communication.

### **1.3.6 OTHER BENEFICIARIES**

In addition to persons with disabilities, many others derive huge benefits from an accessible and inclusive environment and flexible services, including:

- People with a temporary injury (such as sprained ankles, fractures, etc.)
- Pregnant women or parents with infants
- Parents who push strollers or buggies
- Children
- Older adults and seniors
- People of different languages
- First aid and emergency service personnel
- Travellers carrying heavy luggage
- People who need to travel with a companion

At any given time, a significant percentage of the population is a beneficiary of an accessible environment. Even more importantly, almost everybody will become a beneficiary of an accessible environment at some stage in their lives, as a result of the natural aging process and its accompanying reduction of sensory and physical function.

## 1.4 MEASUREMENTS AND CONVERSIONS

In order for this Guide to be successful in facilitating an inclusive approach, its contents should be reviewed and applied by a wide-ranging audience.

All measurements and graphics included in this document follow the graphic standards described below.





LEGEND	
	Dimensions use metric system
	Dimensions for small measurements
	Dimensions showing a range with minimum-maximum
min	Minimum
max	Maximum
>	Greater than
<	Lesser than
≥	Greater than or equal to
≤	Lesser than or equal to
	Boundary of clear floor space for maneuvering space
	Center Line Direction of travel or approach
	A wall, floor, ceiling or other element cut in section or plan
	A highlighted accessible element in elevation or plan
	Tactile or accessible feature

Figure 1: Measurement and graphics standard

## 1.5 KEY CONCEPTS AND NOTIONS ON ACCESSIBILITY

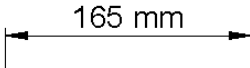
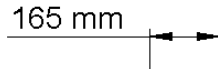
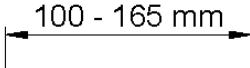
This section defines the main concepts and notions around accessibility.

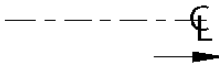
Term	Definition
Accessible environment	An accessible environment is one where there is no barrier that would prevent it from being safely and confidently negotiated by people with intellectual, physical, sensory and mobility difficulties.
Adaptable design	Adaptable design incorporates certain fundamental accessibility features and paves the way for others to be added later, if needed. The overall philosophy is one of contingency: if needed, accessibility can be improved without major renovation.
Design requirements	A list of the important characteristics the design must meet to be successful. Design requirements can fall into many different categories, such as size, cost, ease of use, and environmental impact.
Medical vs. socio-political model for disability	<p>The medical definitions on disability focus attention exclusively to individuals. These definitions assume the limitation results from medical pathology and resides within the individual.</p> <p>The socio-political model explicitly examines the architectural, socioeconomic and policy environments within which people with a disability operate, and this shapes their experience of disability.</p> <p>According to the socio-political model of disability, the medical model fails to measure the impact of external, socially-created factors in disabling people's capacity to perform 'expected' social roles.</p>
Societal attitudes	Societal attitudes can be as much an obstacle as any physical barrier. A fundamental element of any conscious effort to implement universal design principles and practices in a society needs to be accompanied by awareness and training activities to reduce the negative impact of societal attitudes on development of universal design principles.

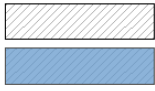
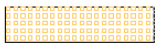
Term	Definition
Universal design	<p>Universal design is a concept or philosophy for designing and delivering products and services that are usable by people with the widest possible range of functional capabilities. Other definitions for universal design are quite similar and include terms such as:</p> <ul style="list-style-type: none"> <li>• “products and environments usable... to the greatest extent possible, without the need for adaptation or specialised design”,</li> <li>• “widest spectrum of users”,</li> <li>• “equal opportunity for use”,</li> <li>• “... by all ages and varying abilities”,</li> <li>• “as usable as possible by as many people as possible, regardless of age, ability or situation”.</li> </ul>

## 1.6 GLOSSARY

This section lists the main definitions of specific terms used throughout the Guide. The Guide uses the core terminology created by the IOC and IPC for the Olympic and Paralympic Games.

***Amenity*** - something that helps to provide comfort, convenience, or enjoyment.

***Assistive listening systems (assistive listening devices)*** - amplifications that bring sound directly into the ear. They separate the sounds, particularly speech, that a person wants to hear from background noise. The devices help address listening challenges in three ways: minimising background noise; reducing the effect of distance between the sound source and the deaf or hard of hearing person; and overriding poor acoustics such as echo. People use them in places of entertainment, employment and education, as well as for home/personal use.

***Audio haptic technology (devices)*** - tools for people with vision impairment to explore graphics by recreating the sense of touch by applying forces, vibrations, or motions.

***Blended transition*** - transitions to the street that have a grade less than 5%. Depressed corners and fans are considered blended transitions. In the past, the term ‘blended transition’ typically referred to the design now known as depressed corners.

***Braille*** - a tactile system of writing for people with vision impairment that uses characters made up of raised dots.

***Building*** - a usually roofed and walled structure built for permanent use (as for a dwelling).

**C-value** - the vertical distance in mm between the line of sight and the eyes of the person in front. This measurement is used while designing the seating for a stadium.

**Circulation path** - an exterior or interior way of passage from one place to another for pedestrians including, but not limited to, walks, hallways, courtyards, stairways, and stair landings.

**Cluster** - a group of two or more sites (venue facility) in close geographical proximity, which do not have a common venue/precinct secure perimeter. The operations of the sites may impact on each other and should therefore be integrated to the extent necessary.

**Cognitive** - of, relating to, being, or involving conscious intellectual activity (such as thinking, reasoning, or remembering).

**Competition venue** - a sport competition site of primary importance, operated by the Organising Committee of the Games and its partners/agencies (by a multi-functional venue team), located within a venue/precinct secure perimeter, subject to the exclusive use of the OCOG, officially used for Olympic and/or Paralympic competition.

**Cross slope** - a slope that is perpendicular to the direction of the travel.

**Detectable warning** - a distinctive surface pattern of domes detectable by cane or underfoot that alert people with vision impairments of their approach to street crossings and hazardous drop-offs. They are used to indicate the boundary between pedestrian and vehicular routes where there is a flush instead of a curbed connection. Detectable warnings also indicate unprotected drop-offs along the edges of boarding platforms at transit stations and stops.

**Emergency assistance alarm** - an alarm kit which includes everything required for a compliant emergency assistance alarm. It allows a distressed person to raise an alarm in the event of an emergency. To operate, the user simply pulls the cord of a ceiling pull unit to activate a light and sounder outside the toilet.

**Facility** - all or any portion of buildings, structure, site improvements, complexes, equipment, roads, walks, passageways, parking lots, or other real or personal property located on a site.

**Games seated capacity** - The total number of spectator seats available at a venue during Games-time operations before seat kills are considered. This figure does not include accredited seats.

**Incline walkway** - hallways with an incline floor that converts the hallway floor to a ramp(s) to save space.

**Inclusive design** - design of buildings, products or environments to make them accessible to all people, regardless of age, disability or other factors. Inclusive design aims to remove the barriers that create undue effort and separation. It enables everyone to participate equally, confidently and independently in everyday activities.

**Kerb ramp** - a kerb ramp is a means for transferring safely and efficiently from a sidewalk into a roadway or another walking path.

**Kerb line** - a short ramp cutting through a kerb or built up to it.

**Marked crossing** - a crosswalk or other identified path intended for pedestrian use in crossing a vehicular way.

**Non-competition venue** - a non-competition site operated by the OCOG and/or its partners/agencies, located within a venue/precinct secure perimeter, subject to exclusive use of the OCOG and/or its partners/agencies, officially used to deliver the Olympic and/or Paralympic Games. A competition venue may also host non-competition activities but is not classified as a non-competition venue.

**Pathway** - a track that constitutes or serves as a path.

**Person(s)/People with short stature** - typically defined as an adult height that is more than two standard deviations below the mean for age and gender, which corresponds to the shortest 2.3% of individuals.

**Person(s)/People with disability** - those who have long-term physical, mental, intellectual or sensory impairments which in interaction with various barriers may hinder their full and effective participation in society on an equal basis with others.

**Pictogram** - a visual presentation of data using icons, pictures, symbols, etc., in place of or in addition to common graph elements (bars, lines, and points). Pictographs use relative sizes or repetitions of the same icon, picture, or symbol to show comparison. Also called pictogram, pictorial chart, pictorial graph, or picture graph.

**PRM** - People with reduced mobility.

**Ramp** - a sloping surface joining two different levels, as at the entrance or between floors of a building; usually has a running slope greater than 1:20.

**Ramp assembly** - a complete set of components of a ramp that may include entry landing, intermediate landing, ramp run(s), rest area(s), exit landing, handrails, edge protection, weather protection, illumination, graphics, communications, etc.

**Ramp run** - a single run of a ramp between landings.

**Running slope** - a slope that is parallel to the direction of travel.

**Sign language interpreter** - a person trained in translating between a spoken and a signed language.

**Sign languages** - languages that use the visual-manual modality to convey meaning. Language is expressed via the manual sign stream in combination with non-manual elements. Sign languages are full-fledged natural languages with their own grammar and lexicon.

**Signage** - displayed verbal, symbolic, tactile, and pictogram information.



**Site** - a spatial location of an actual or planned structure or set of structures (such as a building, town, or monuments). The term is also used to refer to all areas where organisers operate to deliver the Olympic and/or Paralympic Games.

**Tactile** - describes an object that can be perceived using the sense of touch.

**Tactile guideways** - a system of textured ground surface indicators found on many footpaths, stairs and platforms to assist blind and vision-impaired pedestrians.

**Transfer Board** - a board used to slide a sitting person from one location to another, such as from a bed to a wheelchair or from a wheelchair to a car seat. Traditionally, transfer boards were made out of wood but today sophisticated, rigid plastics make transfer boards lighter and more flexible while still strong enough to support one's weight.

**Transfer device** - transferring facilitations that are used when an individual needs assistance with moving from one place to another because of physical limitations or challenges. Transfer devices come in a multitude of sizes, shapes and styles to assist patients and their caregivers in these kinds of daily situations. They can help during activities such as using the bathroom or a public restroom, getting into and out of a car, taking a bath or shower, or moving into or out of a bed, chair or wheelchair.

**Transfer plate** - a plate that is used to fill up a gap between the wheelchair and the car seat and makes boarding much more comfortable.

**Vehicular way** - a route intended for vehicular traffic, such as a street, driveway, or parking lot.

**Venue** - a place where events of a specific type are held - for example, an organised event such as a concert, conference, or sports competition.

**Wet room** - a bathroom in which the shower is open or set behind a single wall, its floor area being flush with the floor of the rest of the room and the water draining away through an outlet set into the floor.

**Wheelchair charging area** - a clear floor area where people with powered wheelchairs can recharge the batteries.

**Wheelchair space** - a space occupied by a wheelchair and its user.

**Wheelchair space location** - a space for a minimum of a single wheelchair user and associated companion. Space locations can contain multiple wheelchair spaces and associated companion seating.

# **CHAPTER 2**

## **QUICK REFERENCE GUIDE**



## 2 QUICK REFERENCE GUIDE

### 2.1 KEY MEASUREMENT REFERENCE TABLE

The following table refers to the key sections and measurement references from all the technical specifications chapters (Chapters 3 to 6). This table should be used in conjunction with the full chapter, as it does not provide the same level of detail and includes only the key measurements most often referenced.

Area	Key item	Measurement	Comments
Pathways and circulation areas	Pathways	Width: 1,000mm (min with restrictions) 1,500mm (low traffic) 1,800mm (Mid. traffic) 2,000 mm (High traffic) Clear headroom space: 2,100mm	<ul style="list-style-type: none"> <li>Pathway width measurements are applicable to ramps, queuing areas, aisles, etc.</li> <li>1,000mm will be usable only for distances of 1,000mm max.</li> <li>Long pathways or outdoor spaces should provide a bench every 50m.</li> </ul>
Ramps	Slope	1:20 (5%) min. grade best practice 1:14 (7.14%) min. grade for height up to 3000mm 1:50 (2%) maximum cross slope	<ul style="list-style-type: none"> <li>1:20 applies as max. grade for ramps serving primary entrances or busy facilities, long or crowded walkways, or for covering more than 3000mm height difference.</li> <li>1:14 (7.14%) max. grade is acceptable for secondary or ancillary facilities.</li> <li>Ramps should not exceed 60m in length.</li> </ul>

Area	Key item	Measurement	Comments
	Width	<b>1,500mm</b> (minimum).	<ul style="list-style-type: none"> <li>Measured between handrails.</li> <li>Refer to Section 4.4 - Ramps for details on when the width should be larger based on specific conditions.</li> </ul>
	Landings	Landing every time ramp covers a vertical height difference of <b>500mm</b> Width: same as ramp width Length: <b>1,500mm min</b>	
	Handrails	<b>850-950mm</b> above ramp surface <b>35-45mm</b> grip surface <b>45-60mm</b> from wall surface <b>300mm</b> extension beyond start and end of ramp	<ul style="list-style-type: none"> <li>Handrails are needed for height differences of more than <b>300mm</b> and are required on both sides.</li> </ul>
	Kerb ramps	<b>1:20 Slope (5%)</b> Slopes adjacent to kerb ramp should be <b>1:50 (2%)</b>	<ul style="list-style-type: none"> <li>Slip resistant surfaces.</li> <li>Detectable warning surface (colour/texture contrasted).</li> </ul>
Stairways	Treads and risers	<b>125-180mm</b> height of risers <b>280-350mm</b> depth of treads	
	Nosings	<b>38mm</b> maximum	<ul style="list-style-type: none"> <li>Non-slip, high contrast.</li> </ul>
	Detectable warnings	Depth: <b>600mm</b> Width: width of the stairs	
	Handrails	See handrails section above	
Furniture, counters and service areas	Reception desks / service counters	<b>850mm</b> height <b>750mm</b> knee clearance <b>500mm</b> depth <b>750mm</b> width (minimum)	<ul style="list-style-type: none"> <li>Main service area should be accessible. Avoid segregated cut-outs/service areas for wheelchair users.</li> </ul>

Area	Key item	Measurement	Comments
	Waiting and queuing areas	<b>1,500mm</b> min. width for each line <b>1:50 (2%)</b> maximum slope allowed	<ul style="list-style-type: none"> <li>Rest benches needed where line is longer than <b>50m</b>.</li> </ul>
	Serving Counters	<b>850mm</b> surface height <b>510mm</b> reach requirement (front and side reach) <b>300mm (w) x 200mm (d)</b> min clear space for food preparation	
	Restaurant / lounges / food court seating	<b>1,500mm</b> min. main pathway width <b>1,000mm</b> min. aisle width <u>Bar seating</u> : include lowered section <b>850mm</b> height, <b>750mm</b> knee clearance, <b>1,600mm</b> minimum width <u>Bench seating</u> : provide back support, with max. <b>450mm</b> seat height and <b>750mm</b> backrest height, plus minimum kick space of 1/3 seat depth	<ul style="list-style-type: none"> <li>Mix of chairs should be provided - 20% with arms.</li> </ul>
Doors and doorways	Door width	<b>850mm</b> minimum (clear width) <b>950mm</b> best practice (clear width) <b>1,000mm</b> required for specific sports' athlete preparation areas	<ul style="list-style-type: none"> <li>Measured when door is open 90 degrees.</li> </ul>
	Door requirements	<b>150mm</b> min. inside handle dimension <b>900-1,100mm</b> handle height from floor <b>500mm</b> clear space on pull side <b>300mm</b> clear space on push side	<ul style="list-style-type: none"> <li>Handles operable by one hand.</li> <li>Sliding doors are preferable.</li> <li>Revolving doors are not considered accessible.</li> </ul>
Elevators	Doors	<b>850mm</b> minimum clear width <b>950mm</b> minimum clear width for elevators serving public spaces and sport facilities	

Area	Key item	Measurement	Comments
	Car	<b>1,700mm x 1,500mm</b> min. clear size <b>2,100mm x 1,500mm</b> best practice for high public use elevators (sport, entertainment)	
	Controls	<b>250mm</b> from front return panel on side wall <b>850-1,200mm</b> button height range from floor <b>20mm</b> button diameter	<ul style="list-style-type: none"> <li>Buttons shall have raised characters for letters, numbers and Braille (immediately to the left of buttons).</li> <li>Synthesised voice floor callers for direction and destination.</li> </ul>
Emergency provisions	Areas of rescue assistance	<b>850mm x 1,300mm</b> min. space per anticipated user (no fewer than two spaces)	<ul style="list-style-type: none"> <li>See emergency provisions section for further detail on provision and use of these spaces.</li> </ul>
	Alarms	Visual fire alarms max. allowable strobe flash rate: <b>1-3 Hz</b> <b>1,200mm</b> max. operating height of alarms pulls and safety equipment	<ul style="list-style-type: none"> <li>Visible in all public gathering areas, washrooms, and in front of elevators.</li> <li>Emergency call buttons recommended for washrooms with facilities for wheelchair users.</li> </ul>
	Evacuation instructions	<b>1,300mm</b> max. mounted height	<ul style="list-style-type: none"> <li>Large print (min <b>14pt</b> font).</li> <li>High contrast (i.e. - red on white).</li> </ul>
Venue seating	Accessible seating	<b>Best practice:</b> See Section 3.6 Spectators Venue accessible seating for a detailed calculation of the	<ul style="list-style-type: none"> <li>Calculation is based on Games seated capacity. The total number of spectator</li> </ul>

Area	Key item	Measurement	Comments
		<p>number of spectator accessible seats in a venue.</p> <p><u>Space requirements:</u>  <b>800mm x 1,300mm</b> for the user of the accessible seat  <b>500mm x 1,300mm</b> companion/enhanced amenity  <b>1,000mm</b> minimum circulation space behind the accessible seat</p>	<p>seats available at a venue, before seat skills are considered.</p> <ul style="list-style-type: none"> <li>• Additional consideration is made for venues where standing tickets are sold to ensure there are accessible viewing areas.</li> <li>• Companion seating to be provided at an equal ratio, next to (not behind) each space.</li> <li>• Additional enhanced amenity seats (seats suitable in width and access by persons with mobility or sensory disabilities, such as people using crutches, people with guide dogs or people using a hearing augmentation system or device) should be provided at a min. ratio of <b>1%</b> of Games seated capacity.</li> </ul>
	Sightlines	Sightlines of accessible seating provide the same sightline for a person seated in a wheelchair when a person in front stands up, as the person in front has when standing.	<ul style="list-style-type: none"> <li>• Railings and other obstacles should not impair the sightlines of people using accessible seating.</li> </ul>
Washrooms	Numbers and ratios	<b>1:15</b> (one toilet for every 15 accessible seats in a venue or in the locker rooms of back of house, the ratio	<ul style="list-style-type: none"> <li>• Every bank of toilets has one gender-</li> </ul>

Area	Key item	Measurement	Comments
		applies to athletes with mobility impairment) minimum ratio for accessible toilets. Where only one toilet is provided, it should be made accessible.	neutral accessible facility adjacent.
	Signage	<b>1,350mm</b> mounted from the floor on the wall (on the latch side of the door, not on the door itself)	<ul style="list-style-type: none"> <li>Standardised symbols used with raised lettering 1mm in height.</li> </ul>
	Circulation spaces	<b>2,200mm x 1,800mm</b> clear space of a gender-neutral accessible washroom <b>1,500mm x 1,500mm</b> clear space of a gender-specific accessible toilet <b>850mm</b> min. door width (950mm best practice) <b>750mm</b> transfer space next to toilet lid, with <b>800mm</b> being best practice	<ul style="list-style-type: none"> <li>A gender-neutral accessible washroom includes toilet pan, wash basin, grab rail, mirror, soap, paper towel, toilet paper dispensers.</li> <li>Light operating door closer (<b>20Nm</b>) and self-closing.</li> </ul>
	Fixtures	<b>450mm</b> toilet pan from side wall <b>440-460mm</b> toilet seat height <b>750mm</b> long L-shaped grab bars, mounted: <b>230mm</b> above toilet seat, <b>150mm</b> in front of toilet seat <b>600mm</b> min. height of toilet paper	<ul style="list-style-type: none"> <li>Back support should exist where there is no lid or tank.</li> <li>Tank lid securely attached.</li> <li>Toilet flush controls electronic or within reach on transfer side (opposite the wall/grab bar).</li> </ul>
	Sink area	<b>900-1,100mm</b> height of accessories, <b>750mm</b> from the centre of the sink Mirror immediately above the basin at a height of <b>1,800mm</b> <b>150mm</b> maximum basin depth <b>680mm</b> basin height clearance	<ul style="list-style-type: none"> <li>Accessories include soap dispenser, paper towel, etc.</li> <li>Hands-free tap is preferred.</li> <li>AC outlet should be located close to toilet for powered-adaptive devices.</li> </ul>



Area	Key item	Measurement	Comments
Showers, baths and changing rooms	Accessible shower features	<p><u>Water control:</u> mounted <b>750mm</b> from the floor and <b>750mm</b> from end wall</p> <p><u>Folding seat:</u> <b>480mm</b> deep, <b>850mm</b> long, mounted <b>440-460mm</b> from floor, 135kg load capacity</p> <p><u>Handheld shower:</u> <b>1,500mm</b> hose</p> <p><u>Grab bars:</u> <b>750mm</b> (along folding seat wall) x <b>900mm</b> (along shower wall) set horizontally, <b>850mm</b> above the floor</p>	<ul style="list-style-type: none"> <li>• Lever operated faucet with <b>13N</b> operating force.</li> <li>• Recessed soap holders or shelves within easy reach.</li> <li>• Scald guard or thermo-controlled valve.</li> <li>• See Figure 42: Bathroom fixtures schematic.</li> </ul>
Transportation	Transport load zone	<p>Aisle: <b>2,400mm</b> (w) x <b>7000mm</b> (l)</p> <p><b>3,300mm</b> height allowance</p>	<ul style="list-style-type: none"> <li>• To be equipped with at least one kerb ramp.</li> </ul>
	Parking area requirements	<p><b>2%</b> (best practice is 3%) of spaces should be accessible</p> <p><b>2,300mm</b> minimum height clearance (<b>2,500mm</b> best practice) for underground parking</p>	<ul style="list-style-type: none"> <li>• Spaces should be in the most convenient location based on entries and exits, lifts and ramps, accessible toilets and pay stations.</li> </ul>
	Accessible parking spaces	<p><u>Width:</u></p> <p><b>3,200mm</b> (minimum)</p> <p><b>3,600mm</b> (best practice)</p> <p><u>Signage:</u> <b>1m x 1m</b> size of international symbol on ground, <b>1,500mm</b> height of vertical international symbol sign</p>	<ul style="list-style-type: none"> <li>• See Chapter 4 All accessible routes for information regarding access provisions.</li> </ul>

Area	Key item	Measurement	Comments
Accommodation sites	Room	Circulation and change of direction: one space <b>1,500 mm x 1,500 mm</b> Transfer spaces: <b>min. 750mm</b> , best 800mm Paths and passageways: at least <b>1000mm</b> Controls/switches: <b>850mm - 1,200mm</b> Electrical outlets and data connections: at <b>450mm</b> Manoeuvring space in front of closets: <b>1,500mm</b>	<ul style="list-style-type: none"> <li>• Bed top height: 450-500mm.</li> <li>• Bedside tables: min. toe space of 225mm high x 300mm deep.</li> <li>• Operators of window/curtains: extend to at least 1,200mm.</li> <li>• Mounted hanger rod: 1,200mm.</li> </ul>
	Wheelchair-friendly room	Door widths minimum <b>800mm</b> One spot within the room with a diameter of <b>1,200mm x 1,200mm</b> Transfer space of <b>min. 750mm</b> on at least one of the bed sides Height of controls lower than <b>1,400mm</b> or provide 'handling stick' Toilet seat of min. <b>450mm</b> height with transfer space on one side	<ul style="list-style-type: none"> <li>• Long stick, to allow mounting and demounting of hangers in cupboards.</li> <li>• Portable bath amenities.</li> <li>• Shower chair with back and/or handrails in the bath tube.</li> </ul>

## **2.2 EVENT ACCESSIBILITY CHECKLIST**

### **Presentation**

The event accessibility checklist is a general reference tool for the key accessibility elements to incorporate in an event. The purpose of this checklist is to provide relevant information for the planning of events that are local, national or international in scale (it is not Games-specific). For specific information about the Olympic and Paralympic Games, see Chapter 7 Olympic and Paralympic Games Specific Guidelines.

Further detail on the accessibility criteria referenced below can be found in the technical specifications chapters (Chapter 3 - 6) and section 2.1 Key measurement reference table.

### **Accommodation**

- Accessible rooms available in hotels / lodging fulfilling the accessible criteria detailed in Section 6.6 Hotel.
- Services and entertainment areas of the hotels are accessible to all users.

### **Accreditation**

- Capture relevant mobility information (daily wheelchair users) and specific needs (request for materials in alternative formats) as part of the registration of event participants.
- Accreditation centres meet the accessibility criteria for signage, pathways, entry points, washrooms, service counters and parking.

### **Airport operations**

- Flow through the airport allows unobstructed, independent access for all.
- Airlines are prepared (through shuttles, aisle chairs, luggage assistance) for an increase in the demand for accessible operations.
- Accessible transportation options available for event participants to and from the airport.

### **Broadcasting**

- Accessible commentary positions, and accessible access to all media services.

### **Catering**

- Pathways, aisles and queuing areas meet accessible pathway requirements.

- Allocation of products (beverages, desserts, etc) in a vertical (rather than horizontal) configuration.
- Serving counters and cafeteria-style services incorporate lowered counter surface (**850mm**) with knee clearance (**750mm**).
- Serving trays are provided.
- Condiment counters are accessible (see section 3.5 Reach range, knee and toe clearance) with a maximum reach requirement of **600mm** from front edge and clear space for food preparation.
- Seating area: accessible seating options including tables that allow for knee clearance (**850mm** height, **750mm** knee clearance), chairs provide kick space of one third of seat depth, mix of chairs with and without arms available.
- Where high top / bar tables are being used, lowered section for wheelchair users is available.

### **Ceremonies / stage presentations**

- Concurrent translation in sign language and/or text on the video boards.
- Hearing augmentation system (provision of assistive hearing devices) and live audio description services for people with sensory limitations.
- Programmes available in alternative formats (large print, Braille).
- Wheelchair access to stage (following accessible ramp criteria).
- Accessible podium (preferable a variable height podium) and lapel mic.

### **Cleaning and waste**

- Waste bins are visible to those with vision limitations, do not obstruct pathways (less than accessible standards), are detectable by people using sticks, are at a maximum height of **1,200mm**, and require minimal hand dexterity to operate.

### **Communication / publications**

- Accessible services and operations for the event and host community are communicated through information materials (brochures, online, etc.).
- Media services provide alternative formats of material and sign language interpretation of press conferences, upon request.
- Website meets W3C accessibility provisions.
- Publications in alternative formats (large print, Braille, etc.).

### **Doping control**

- Gender-neutral accessible washroom is available.
- Information materials provided in alternative formats (large print, Braille, etc.).

### **Event services**

- Monitoring and maintaining accessible pathways for spectators.
- Spectator information materials made available in alternative formats (Braille, large print, etc.).
- Distribution of assistive hearing devices to spectators.
- Provision of wheelchair loan and storage services.
- Assisting with elevator access and use; facilitating priority loading for wheelchair users as required.
- Event services staff provided adequate training on service to customers with a disability.

### **Medal ceremonies and sport presentation**

- Medal podium ramped for athletes that are wheelchair users, at a maximum grade of 1:12 (8.33%) and up to 300mm height for first place.
- Announcers trained in specific sport terminology and proper language for referring to Para athletes.

### **Medical services**

- Medical areas comply with accessibility provisions.
- Where competition includes specialised equipment (such as sport chairs), provide access to specialised repair services.

### **Merchandising / retail operations**

- Pathways, aisles and queuing areas meet accessible pathway requirements.
- Allocation of products in a vertical (rather than horizontal) configuration.
- Service counters are accessible, incorporating a lowered counter surface (850mm) with knee clearance (750mm).

### **Overlays and site management**

- Complete thorough assessment of accessibility compliance needs for every venue; identify areas where temporary overlay is required for accessibility solutions.
- Ensure proper installation and maintenance of accessibility features.

### **Press operations**

- Accessible access to all press facilities, including pathways, communication materials, seating, food services, and washrooms.

- Where transportation and accommodation are being provided to media, ensure accessible services are available upon request.

### **Security**

- Where security screening areas are applicable, ensure an operational gate (width of **1,000mm**) without a magnetometer and a hand-wand device is available for security screening.
- Security personnel require special training to ensure screening of persons with disabilities allows for dignity (for the customer) and efficiency (for security).
- Ensure security perimeters do not impede accessible pathways and routes.

### **Signage and wayfinding**

- Graphic elements comply with accessibility standards (colour contrast, size of letters, position of signs).
- Wayfinding signage complies with accessibility standards (use of international symbols, use of Braille and raised lettering, glare free, high contrast, Arabic numerals and sans serif lettering).
- Wayfinding signage to highlight accessible pathways and services.

### **Sport**

- Where applicable, the competition requirements specific to adaptive / Paralympic sports are met.
- Accessible criteria, including all connecting pathways, are met for all athlete areas: locker rooms, warm-up areas, field of play, mixed zone, doping control, medal presentation, press conference, athletes lounge, seating areas.
- Adequate accessible seating for athletes and team officials.
- Sport publications available in alternative formats.
- Specific sport equipment (such as hand ergometers) made available.
- Accessible transportation and accommodation provided to athletes as required.

### **Ticketing**

- Ticket guides available in alternative formats (large print, Braille, audio, etc.).
- Ticketing website fulfils accessibility requirements (W3C), including an alternative to 'human test' image capture for visually impaired users.
- Ticket box offices meet accessibility requirements for counter height and queuing.
- Provide multiple seating options - accessible, companion and enhanced amenity seats - in a range of locations and ticket price categories.
- Identify seats within the range of the hearing augmentation system.

## Transportation

- Where transportation services are being provided to event participants:
  - Ensure buses can meet the accessible seating capacity required, through low floor accessible buses (preferable), or those equipped with a wheelchair platform lift
  - Define capacity and timetable for efficient service
- A pool of accessible taxis and passenger vehicles / vans are available for hiring.
- Accessible parking spaces that meet the accessibility criteria (space size, signage, location, pathways, height of underground parking lots).
- Transportation load zones meet accessibility criteria (size, availability of kerb ramp).
- Accessible connecting pathways available from transportation load zones to the venues.

## Venues

- All main footpaths and circulation areas are accessible (**1,800mm** width, with stairways, elevators and ramps following the accessibility criteria).
- Doors are at a minimum **850mm** width.
- Best practice seating requirements:
  - The number of wheelchair-accessible seats is based on the venue net capacity. Refer to Section 3.6.1 Spectator accessible seating for details on spectator accessible seating figures based on a venue's capacity.
  - Companion seats are provided next to the accessible seating positions (with same ratio)
  - Enhanced amenity seating (greater width for people with guide dogs, crutches, walking frames, etc.) are provided at a minimum of **1%** of gross capacity
  - All wheelchair accessible seating provides comparable sightlines and is available in a range of locations and ticket price categories
  - See Section 3.6.2 Sight lines for additional information
- Accessible gender-neutral washrooms available that meet the accessibility criteria.
- All service counters, merchandising and food and beverage services meet the accessibility criteria.
- Change-rooms meet the accessibility criteria for showers and change spaces.
- Emergency provisions:
  - Evacuation plans with an immediate pathway for wheelchair users to a secure assembly area
  - Visual emergency signals located in public areas

**VIP services**

- VIP lounges meet accessibility criteria for service counter height and seating options (where high-top tables are used, lower seating options for wheelchair users are made available).
- Accessible seating provided for VIPs as required, provided in the same location as all other VIP seating.
- Information materials available in alternative formats (large print, Braille, etc.).

**Volunteers / workforce**

- Recruitment that encourages applications from persons with disabilities.
- Policies that enable easier access to work for persons with higher support needs.
- Ensure all volunteer/staff areas meet accessibility criteria:
  - Check in areas: accessible counter heights, seating
  - Break/meeting areas: accessible counter heights, seating, food services
  - Staff toilets: including gender-neutral accessible washroom
- Disability/accessibility awareness training for all staff and volunteers.



# **CHAPTER 3**

**VENUES INTERIOR  
ELEMENTS REQUIREMENTS**

## **3 VENUES INTERIOR ELEMENTS REQUIREMENTS**

### **3.1 INTRODUCTION**

All venues (competition and non-competition) should provide an inclusive environment for all users. In order to accomplish this, the interior elements of the building must be designed to take into consideration the minimum requirements specified in this chapter. The proposed recommendations are based on the general needs found in all venues used during Para sport events. Also, it is important to note that most Para sports will have particular requirements that may involve a detail revision of design requirements when considering an existing facility or designing a new one. For example, sport wheelchairs used in competition events like wheelchair basketball may require modification of standards in certain areas of venues to accommodate the additional width of such wheelchairs.

### **3.2 DOORS, DOORWAYS, AND GATES**

Doors in all buildings should follow basic requirements to allow the circulation of all users regardless of disability. Also, doors that usually function properly for wheelchair users are very convenient for people who have strollers for babies, elders with a walking aid, or someone transporting heavier equipment into a building. Doors are very important as they are the main point of access into a building.

#### **3.2.1 ENTRANCES AND EXITS**

Highlighted below are the key elements of accessibility best practices recommended for entrances and exits that need to be considered to ensure that everybody can safely and appropriately enter and exit a site, building or venue.

#### **3.2.2 ENTRANCE DESIGN**

All entrances should allow independent and safe entry points. This will require the following:

- A clear pathway without threshold steps at the doorway.
- 1,500mm min. clear width should be provided at the main entrance doors of venues, all other doors have a minimum clearance of 950mm. See Figure 2: Clear door opening.
- Clear signage indicating the accessible route.
- Entry mats should be recessed to limit tripping hazard. If reassessing the mat is not feasible, the place mat should not have a profile thickness of more than a

5mm. Mats at many instances should be provided to minimise water or dirt transfer into the building. Mats should be placed away from door swing.

- Push or pull action in doors should be easy and the required force of operation should not be greater than **20N**.
- Automated door closers that use a sensor to open/close the door are the most usable kind for main entrances to venues and provide greater accessibility.
- As revolving doors are not considered accessible, when a revolving door is used, a swing side door with a push button or an automatic sliding door should be placed nearby.
- All door types should follow the minimum door clearances recommended in section 3.2.3 Clear width.

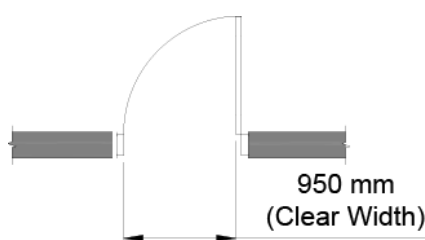

Figure 2: Clear door opening

### 3.2.3 CLEAR WIDTH

The clear opening of all doors should be **950mm** as best practice. The clear width should be measured when the door is open 90 degrees, see Figure 2: Clear door opening.

If doorways have two independently operated door leaves, at least one active leaf shall comply with the minimum clear opening width requirements specified above.

The clear space between two doors in series shall consider in addition to the width of both doors when open 90 degrees, the manoeuvring space in between the two doors. See Figure 3: Door clearances between a series of doors.

**EXCEPTION:** There are instances where what is considered best practice is not enough or it is impossible to comply with because it is an existing structure.

*Existing building* - The minimum allowable clear width is **850mm**. This measurement is feasible to have in certain parts of an existing building. However, it is subject to further study since it could be required to enlarge some of the doors due to traffic or other determining factors.

*Sport chairs* - Depending on the sport, if competition wheelchairs are required, door widths of athlete preparation areas may need to be increased to **1,000mm** regardless of whether the structure is new or existing.

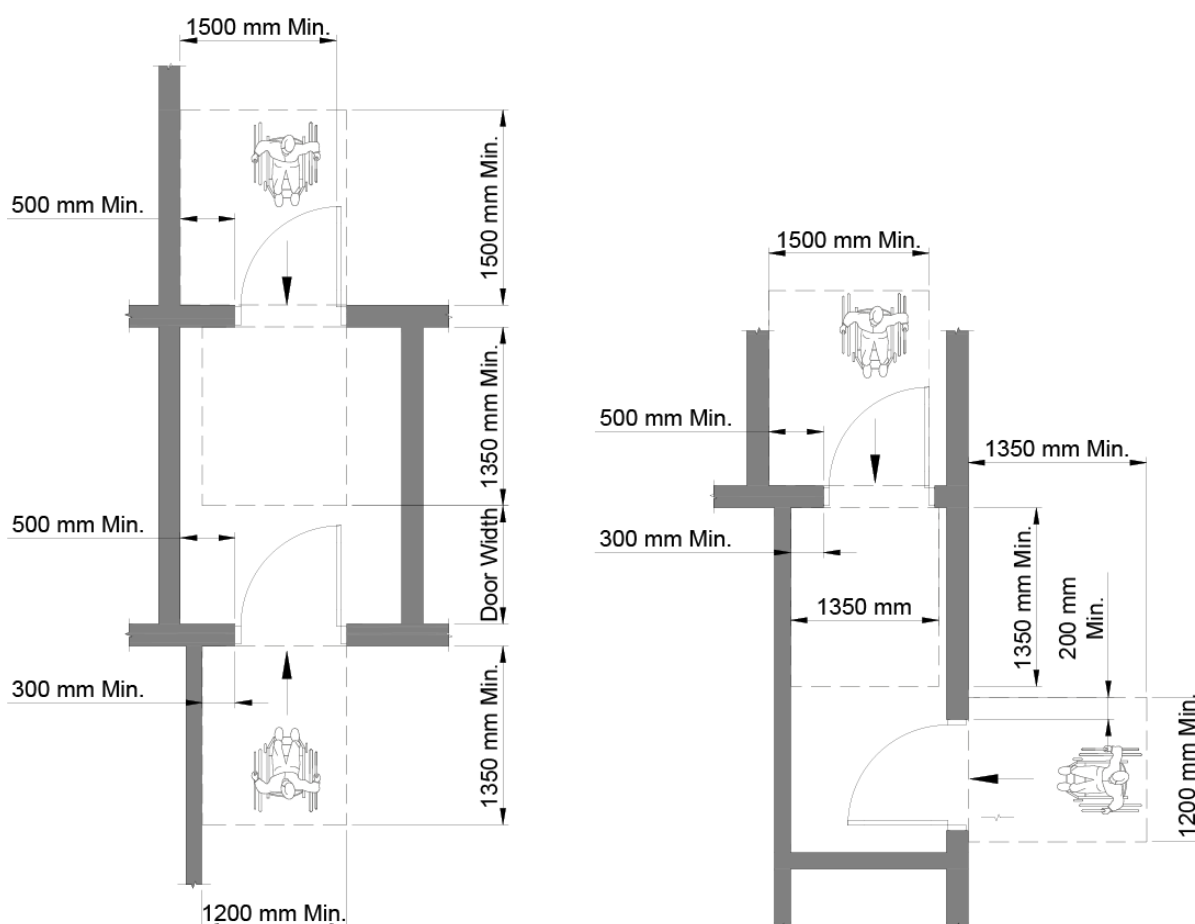

Figure 3: Door clearances between a series of doors

### 3.2.4 POWER OPERATED DOORS

Main entrances to venues or any public building will have high demand and traffic. In many instances, doors are very heavy to operate for a person in a wheelchair or with any mobility aid. If doors are unable to remain open at all times, it is recommended to use power-operated doors. The following criteria should be considered as best practice for power-operated doors.

- If sliding doors are used, they should be equipped with a sensor to detect a moving person as low as **950mm**.
- Power operated doors should place the push button in a visible and reachable area that is away from the swing of the door in order to permit the door to safely operate. Refer to Figure 4: Push button at door for further information, regarding recommended location of push button.
- Push button should be easy to operate and its height position should follow the recommendations made in Section 3.5 Reach range, knee and toe clearance. See Figure 11: Side and front approach.
- Automatic doors should be able to stop with a force of **30N or less**.
- Automatic doors should take at least three seconds to go from a closed to a fully open position.
- Operating hardware on sliding doors shall be exposed and usable from both sides when sliding doors are fully opened or closed.
- If on a fire exit route, door should remain operable in emergency conditions. The push away system should be provided if door is on the exit route. See Figure 5: Push away door for an example.
- Security viewers in a door should be mounted **1,000mm-1,200mm** above finished floor. The outside area must have at least 10lux of flat even light for the benefit of people who have a vision impairment and people who are hard of hearing or deaf (to facilitate visual languages and/or lip reading).

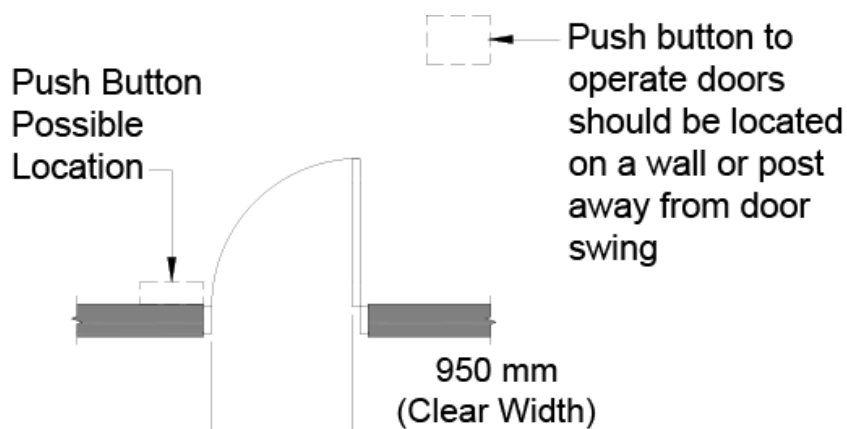

Figure 4: Push button at door

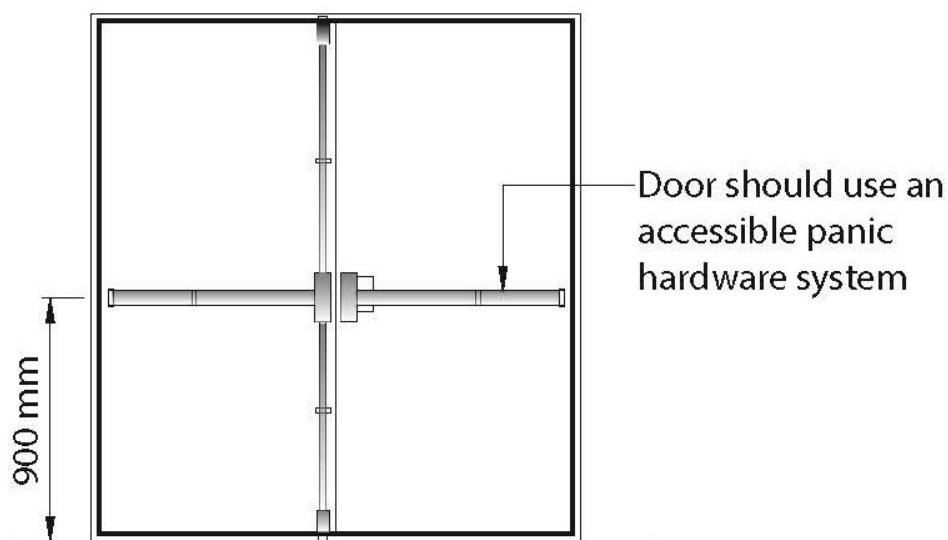

Figure 5: Push away door

### 3.2.5 NON-POWER-OPERATED DOORS

If a power-operated door is not possible, the following criteria should be considered as best practice for non-power-operated doors.

- U-shaped levered handles or D handles providing a minimum inside dimension of **150mm**. These shall be operable by one hand and not require fine control capabilities of a person, while they should be mounted between **900mm-1,100mm** from the floor surface. It is hard for a person with no hands, very little hand movement or a person carrying many things while entering a room to operate a doorknob because it requires the use of hands and fine movements. Refer to Figure 6: Door operating mechanism .
- A **500mm** clear space on the pull side of the door on the latch side.
- Signage/notices should never be posted on doors such that readers would be placed in the swing path of the doors.
- Thresholds are tripping hazards and should be avoided. If necessary, they must meet the minimum requirements described in Section 3.3 Floor surfaces.
- Door leaf shall have a minimum 30% luminance contrast with the frame or adjacent wall. This includes glass doors in glass walls.



Figure 6: Door operating mechanism

### 3.2.6 MANOEUVRING SPACE AT DOORS

Doorways require manoeuvring space to accommodate people with a mobility impairment on both sides of the door and a clear space beside the latch. This space is presented in Table 1: Space requirements in door spaces.

Table 1: Space requirements in door spaces

Context	Depth (mm)	Width (mm)	Clear space beside latch (mm)
Front Approach			
Pull side	1,500	1,500	500
Push side	1,200	1,200	300
Latch-side approach			
Pull side	1,200	1,500	500
Push side	1,050	1,500	600
Hinge-side approach			
Pull side	1,500	1,500	500
Push side	1,050	1,350	450
Sliding doors			
Front approach	1,200	900	50
Side approach	1,050	1,350	540

### 3.2.7 GATES AND TURNSTILES

Where a gate or an access control device (e.g. a magnetometer) is used, a clear opening of no less than **950mm** should also be provided.

Where a gate mechanism is provided, upon operation the gate shall swing away from the user.

Where turnstiles or other ticketing control devices are provided (which are typically not wheelchair accessible) then a gate or opening which is accessible shall also be provided in immediate proximity.

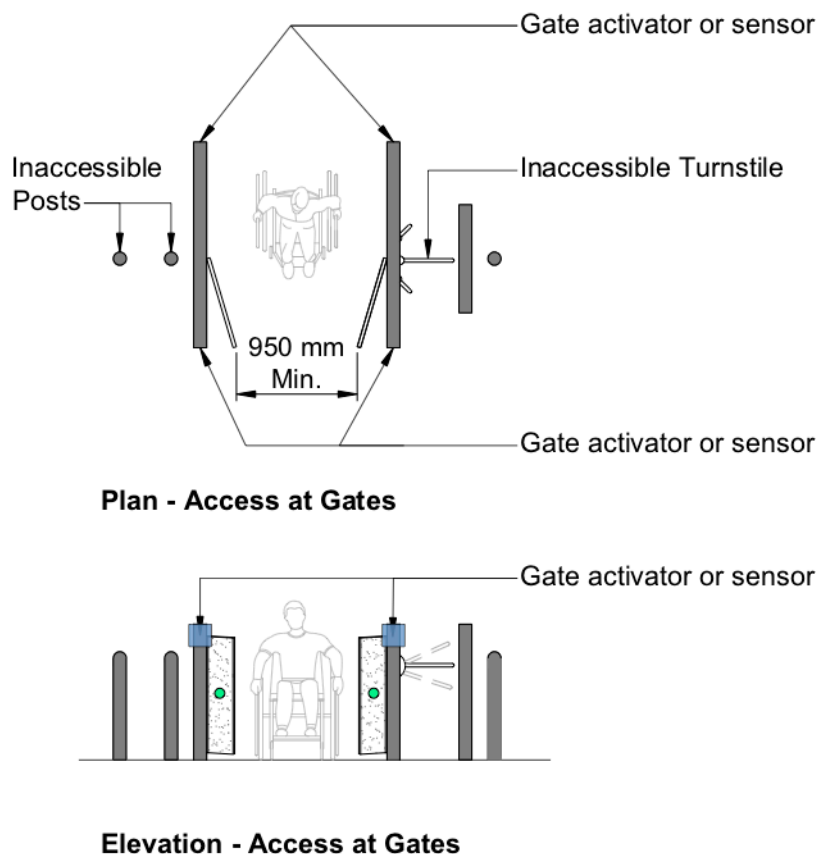

Figure 7: Gates and turnstile

### 3.2.8 MANUALLY OPERATED SLIDING DOORS

- **Sliding doors wood or glass** are easier for some individuals to operate and can also require less wheelchair manoeuvring space. Although they are convenient for many interior small spaces, it is important to consider the proper hardware system that can be used for all.
- **Glazed doors** need to include colour-contrast strips or other indicators to become detectable by people with a visual impairment. See example in Figure 8: Glass door visual.



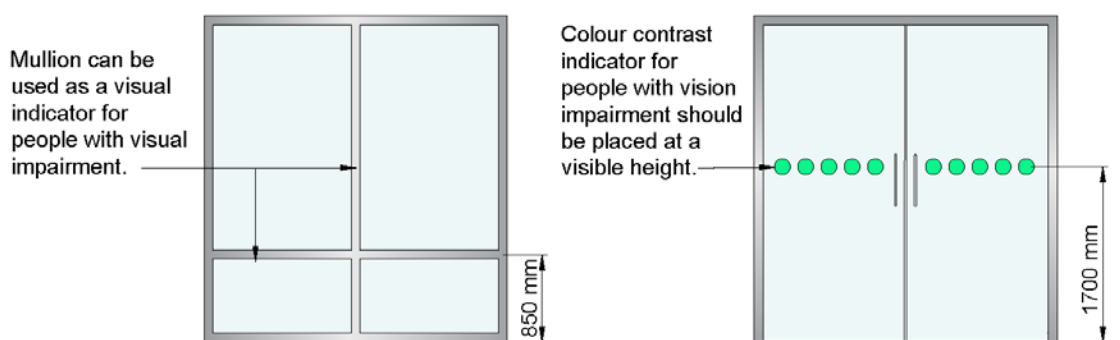

Figure 8: Glass door visual

### 3.3 FLOOR SURFACES

Floor surfaces are a great resource for use in designing an accessible space or path. Although the use of texture and surface materials can be a useful inclusive design tool for wayfinding, especially for people with visual or cognitive impairments, they can create challenges for people with mobility impairments due to the raised texture.

#### 3.3.1 MATERIAL

Some principles should be taken into consideration when selecting a material or designing floor transitions from one material to the other, as they can create a change in level - thus becoming a tripping hazard for many of the users.

- Material should be even and levelled in all areas, including when transitioning from one material to another. Example from carpet to tile, a smooth threshold should be used to have a seamless change.
- In general, the use of carpet is not recommended, as it is difficult for people with a mobility disability to walk or wheel. If used, the carpet should not be thicker than 15mm. Refer to Figure 9: Floor transition details for further details.
- The material must be firm even if it is a landscape material. It is not recommended to use sand, dirt, rocks or even artificial or natural grass on a pathway that will be considered accessible.
- Vertical changes in level greater than **6.4mm** in height should be avoided. Where the change in level is greater than **6.4mm**, a slope should be provided to prevent users from falling. This will help any user regardless of disability.

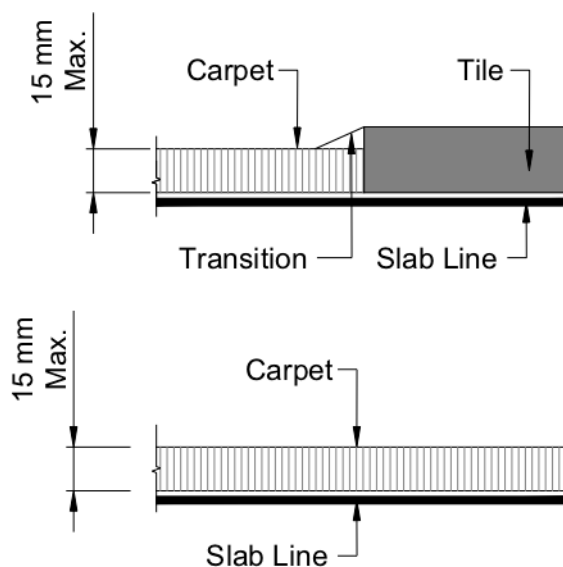

Figure 9: Floor transition details

### 3.4 CLEAR FLOOR SPACE

While using a mobility device it is very important to consider the turning spaces: a person should have the ability to turn around and freely decide where to go at any given time. There are many conditions where this may become a challenge, especially in long, narrow passageways or small rooms. Passageways should also be free of obstacles for those who are vision impaired or simply for the safety of a person walking and not paying attention to the surrounding at any given time.

#### 3.4.1 TURNING SPACE FOR WHEELCHAIRS

While considering the design or adjustment of any space, the minimum requirements described below should be considered to allow wheelchair-users to circulate freely.

- Turning space should be a clear circular space with a **1200mm min.** radius. In some instances, the clear space can be defined by a 'T' shape, which allows a person to manoeuvre under certain conditions. See Figure 10: Turning space clearances.
- Clearance spaces should never be overlapped by objects. It is common to find doors and different objects overlapping into the clearance space which can easily hinder accessibility of the space.

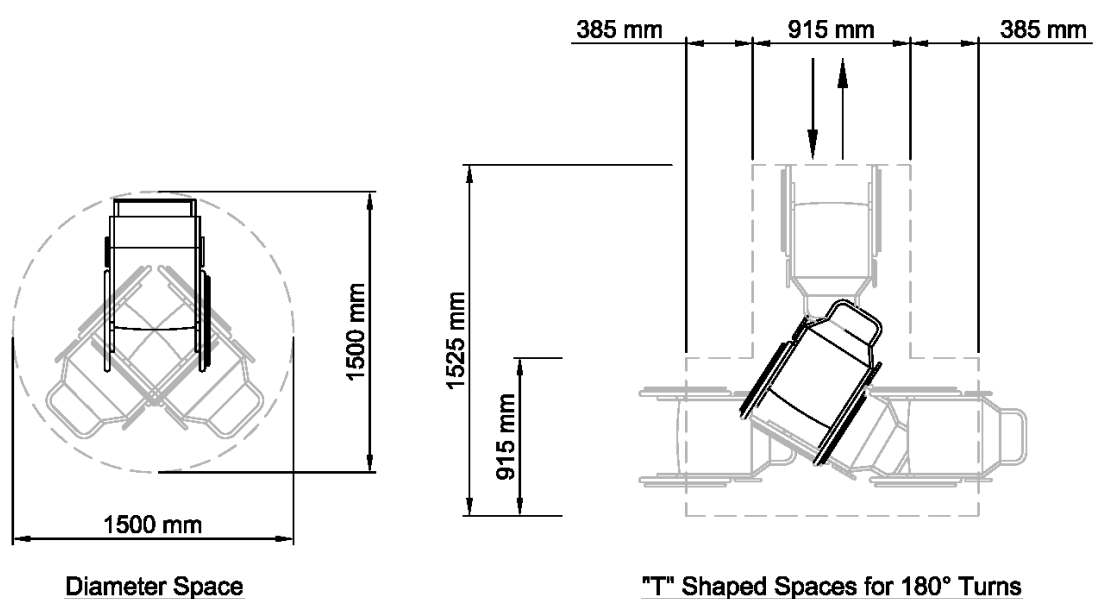

Figure 10: Turning space clearances

### 3.4.2 PROTRUDING OBJECTS

Objects are in some instances allowed to protrude into the space if they do not interfere with the passageway circulation, turning space, or create a hazardous condition to any of the users.

In hallways it is very common to find different objects, such as a fire extinguisher or other items, that can interfere in the space and its clearance. Although such objects can be placed in high-traffic hallways, they must be located in such way that they do not hinder the safety of people circulating.

## 3.5 REACH RANGE, KNEE AND TOE CLEARANCE

It is critical to understand the different reach ranges of a person from different heights and positions in order to make a space accessible and usable by anyone.

There are different positions that people in wheelchairs adopt depending on their ability to approach and use a countertop, desk, sink or similar. Also, it is important to consider the different types of mobility devices and how some of them require clearance under different types of furniture systems.

### 3.5.1 REACH RANGES

While creating accessible spaces, all operable parts of equipment, such as switches, buttons or any other object to be used within such space, must be within reach range of all users.

There are two main approaching methods: forward and side approach. It is best practice to provide both options when designing a space. Refer to Figure 11: Side and front approach.

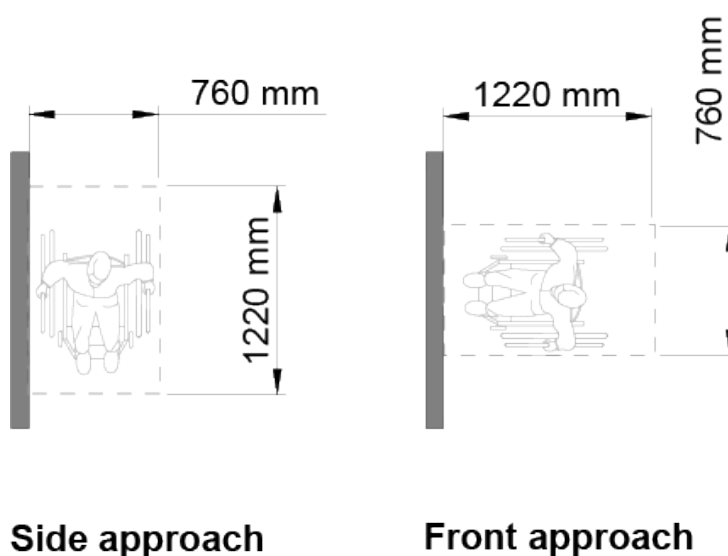

Figure 11: Side and front approach

It is recommended to locate operable parts, especially controls, within the most comfortable obstructed/unobstructed reach, between **750mm and 1220mm** above finish floor, as it allows for a comfortable reach of a person sitting or standing while using any equipment. Refer to Figure 12: Reach ranges.

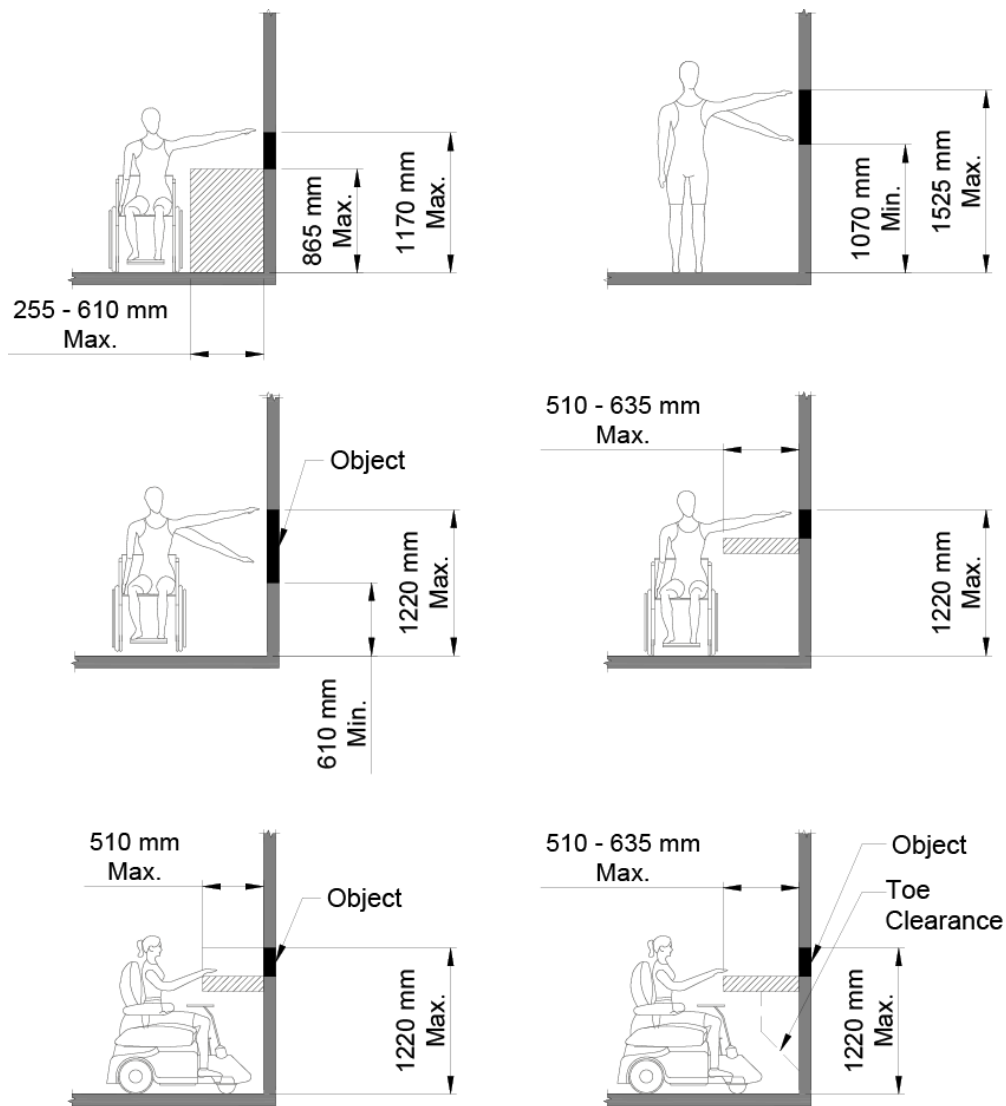

Figure 12: Reach ranges

**EXCEPTION:** In the case of an existing building where it is not possible to accommodate both the front and side approach, at least one of the two approaches must be available.

In the case of a new construction where the best practice recommendation cannot be achieved due to structural conditions of the space, the use of at least one approach method should be achieved in construction.

### 3.5.2 TABLE AND COUNTERS

Interior spaces that provide seating, tables or counters should be made as flexible as possible and provide enough accessible spaces. The tops of accessible tables and counters shall be **850mm** above the finish floor or ground.

If seating spaces for people in wheelchairs are provided at fixed tables or counters, ensure clear floor space complying with front approach requirements described in Section 3.4.1 Turning space for wheelchairs. Such clear floor space shall not overlap knee space by more than **485mm**.

For reception desks, registration counters and other common counters, the main service area must be accessible (although a high service area for standing users may be provided). Where possible, reception and service counters should be one height that is universally accessible to all people.

To ensure proposed knee clearance, if seating for people in wheelchairs is provided at tables or counters, knee spaces should be **750mm** high, **750mm** wide, and **500mm** deep.

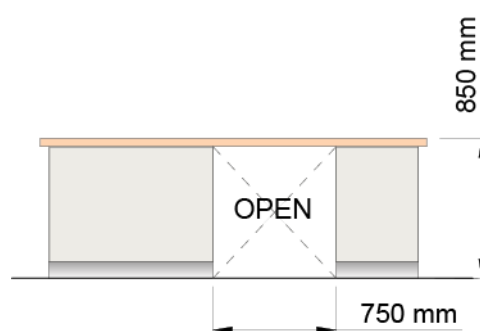

Figure 13: Service counter dimensions

## 3.6 VENUE ACCESSIBLE SEATING

Venues should provide high quality and inclusive seating positions for all spectators regardless of disability.

All the different stadium seating levels and amenities should provide accessible seating and allow spectators the opportunity to decide the seat section to purchase. Spectators who require accessible seating should not be segregated from their groups. All efforts should be made to ensure that family, friends or, if the person belongs to a certain client group within the event, are all seated in the same area of the venue. The described design elements in this section are considered best practise and should be considered when designing new venues.

### 3.6.1 SPECTATOR ACCESSIBLE SEATING

When calculating the number of spectator accessible seats in a venue three main elements should be considered; total number of spectator seats, the sport, and the location of the proposed accessible seats within the venue.

**Table 2: Calculation spectator accessible seating**

Games seated Capacity	Number of accessible seats	Number of accessible seats for wheelchair sports
Under 10,000	1% of Games seated capacity	1.2% of Games seated capacity
10,000 - 19,999	100 plus 8 seats per 1,000 above 10,000	120 plus 10 seats per 1,000 above 10,000
20,000 - 39,999	180 plus 5 seats per 1,000 above 20,000	220 plus 5 seats per 1,000 above 20,000
40,000 or more	280 plus 2 seats per 1,000 above 40,000	320 plus 2 seats per 1,000 above 40,000

Additional considerations are made for venues where standing tickets are sold to ensure accessible viewing areas as discussed in Section 3.6.2 Sight lines.

**Table 3: Examples of spectator accessible seating numbers based on venue size**

Games seated capacity	Number of accessible seats	Number of accessible seats for wheelchair sports
3,000	30	36
5,000	50	60
7,500	75	90
10,000	100	120
15,000	140	170
20,000	180	220
25,000	205	245
30,000	230	270
50,000	300	340
75,000	350	390

### 3.6.2 SIGHT LINES

The primary reason for spectators attending an event is to witness the spectacle and enjoy the sport. Therefore, venues should provide high-quality seating and wheelchair spaces for people with a mobility disability, allowing them a clear, uninterrupted view of the field of play.

It is understood that the field of play for tennis is completely different than that of rowing, for example. Therefore, it is important to ensure that the sight lines provided are appropriate to the environment, the culture and the sport itself.

It is acknowledged that seating for spectators with disabilities should be provided in different areas of the stand or stadium, including upper levels. Spectators with disabilities should be afforded the same quality of view as those without a disability.

In all new stadia and stands, an acceptable viewing standard is obtained with a C-value of **90mm or above**. During exciting moments of sport, or indeed for the national anthem, many seated spectators will stand up. It is therefore vital to obtain a C-value of 90mm or above when taking into consideration a person standing in front of the accessible seating positions in one of the rows below, and how that may obstruct the view of a person with a disability seated behind or to the side.

**EXCEPTION:** In all new stadia provide a C-value of 90mm or above for all wheelchair spaces. In existing stands be aware that additional seat kills will be necessary to achieve this standard. It is acceptable to deviate from this standard if it can be justified in relation to the sport and the differences of the field of play.

Events at open air, cross-country events (rowing, mountain biking) should ensure that dedicated raised platforms are provided at key points. These platforms should offer a clear view above the heads of other spectators and be made available to wheelchair users and others who cannot stand for long periods of time.

In order to create an acceptable sightline for wheelchair users, an increased height riser or 'super riser' should be installed, potentially several times the height of a normal stepping riser. To ensure the pathway to this area is accessible please refer to Chapter 4 All accessible routes for specific information.

In calculating the C-value, consideration should be given to the nature of the sport. In hockey it is an essential requirement for the spectator to be able to have a clear view of the near touchline. In cross country equestrianism, the spectator may require clear view of action in the distance or even above head height. In all cases a clear rationale for calculating the C-value should be provided.



### 3.6.3 ACCESSIBLE SPACES

Where appropriate, a choice of seating positions should be provided at different levels and locations within the venue.

The location of accessible seating positions should enable the spectator to sit with and interact with their own client group; for example, members of a VIP group in standard seats must be co-located with colleagues in the VIP accessible seats.

Additionally, some spectators with a disability will require services to facilitate their full and equal enjoyment of the spectacle. These services could include hearing augmentation systems, real-time open captioning, sign language interpretation, and audio description.

It is recognised that the most appropriate solution at an existing venue or a temporary structure may be different from that which should be applied to a permanent, new-build venue. Nevertheless, the aim should be to provide the best and most appropriate solution on a venue-by-venue basis, using the following information as guidance.

Accessible seating must meet the following requirements to ensure the proper circulation of mobility devices in the space and enjoyment of the spectators:

- An accessible seating space needs to be levelled.
- A space of **800mm x 1,300mm** must be provided for user using the accessible seat.
- An adjacent area of **500mm x 1,300mm** for companion or enhanced amenity seat.
- Circulation space behind needs to offer a minimum width of **1,000mm** to allow the user to comfortably manoeuvre into the space, therefore the overall space required for an accessible seat and companion seat with a pathway behind is: **1,300mm x 2,300mm**.
- No objects or spectators must block the view of other spectators' seating; for example, ensure that there are no barriers or balustrades located in the sight line of the accessible seat user.
- It is desirable to utilise loose companion seats, so there is design flexible with seating arrangements that can provide either banks of accessible seating spaces, single accessible seats with a companion, family groups including a wheelchair user, or a group of wheelchair users.
- Ensure accessible seating is within **40m** of an accessible toilet facility. Accessible toilets must meet the minimum requirements described in Chapter 5 Washrooms and other plumbing elements.

## **3.7 EMERGENCY PROVISIONS**

Emergency response plans need to particularly consider - and provide adequate solutions for - potential users who have mobility, sensory or cognitive limitations. In the event of fire, when elevators cannot be used, areas of rescue assistance must be available to anyone who would have difficulty traversing sets of stairs.

In general, emergency response plans need to particularly consider potential users who have mobility, sensory or mental limitations and provide adequate solutions for them. In the event of fire, when elevators cannot be used areas of rescue assistance must be available to anyone who would have difficulty traversing sets of stairs.

### **3.7.1 EMERGENCY EVACUATION**

All routes acting as 'emergency evacuation routes' need to comply with accessibility standards described in Chapter 4 All accessible routes.

Routes acting as immediate egress to an open and safe area must encompass a barrier-free path of travel to an exit.

### **3.7.2 AREAS OF RESCUE ASSISTANCE**

Areas of rescue assistance shall be provided in all cases where immediate egress to an open and safe area is only available through the use of stairs during an emergency situation.

These areas should be located on an accessible route and have a minimum size of **850mm x 1,300mm** per anticipated potential user. Para sport events require a very strict rescue plan, since a large number of people requiring special assistance are expected. It is recommended that the assigned smoke- and fire-free compartment of the building should not only be in the stairwell but also in the core of the building.

The following requirements are essential:

- Signage should be provided at a height between of **1,800mm and 2,000mm**. The signage lettering should be of high contrast and tactile lettering.
- All doors should swing out into the area of rescue to allow easy access. All doors should comply with the recommendations in Section 3.2 Doors, doorways, and gates.
- Entry doors should be of a contrasting colour to the surrounding surfaces.
- Provide a hands-free intercom or other communications device.
- Provide proper awareness training to staff on the appropriate use of this area.
- Exit stairs should be equipped with glow in the dark, stair nosing or handrails.

### **3.7.3 ALARMS**

The alarm system should alert all individuals regardless of disability.

- A visual fire alarm/strobe warning system is required to operate in conjunction with audible signals and be generally visible in public gathering areas, in all washrooms throughout the facility, and in front of elevators. The maximum allowable strobe flash rate is 1-3 Hz.
- Emergency call buttons (along with proper staff training) should be considered in washrooms that provide facilities for wheelchair users. These devices allow people that may have fallen while making a transfer to or from the toilet to call for assistance (see washrooms). These systems need to be monitored whenever the facility is in use. Where monitoring is not available, an alarm with both audible and visual signals that are noticeable in an adjacent hallway will suffice.
- Fire alarm pulls and fire extinguishers should be installed at an accessible height to permit wheelchair users and others to signal trouble or utilise the safety equipment. These devices are to be mounted at a maximum operating height of **1,200mm** and be placed on an open wall free of obstructions. The same standard applies for fire and emergency alarms in button panels.

### **3.7.4 FIRST AID ROOMS**

All first aid facilities should accommodate all users. This requires tactile/high contrast signage and connecting paths accessible to wheelchair users and people using walking aids. In addition, the typical cot used in most first aid facilities should be replaced with a variable height gurney or change bench. A gender-neutral accessible washroom should also be located in the immediate vicinity of the first aid room.

### **3.7.5 BUILDING EVACUATION INSTRUCTIONS**

Easy-to-read emergency procedures and exit route maps are important components for everyone in the building. To ensure that people with visual impairments and others have access to this critical information, the evacuation instructions for the building need to appear in large print (minimum of 14 point), in high contrast (red on white or vice versa preferred), and include a floor plan diagram with clearly marked exit points. These signs are to be mounted at a maximum height of **1,350mm** from the finished floor and also need to highlight the accessible route to the closest exit and/or rescue assistance area.

### **3.7.6 OTHER REQUIREMENTS**

Other accessibility conditions to improve emergency provisions are:

- Power operated door openers do not continue to operate in all alarmed conditions and hence all doors in the emergency path of travel must comply with

the minimum manoeuvring requirements described in Section 3.2.6 Manoeuvring space at doors.

- In an alarm condition, lighting must assist people to find the way out of an alarm zone.
- Low mounted (480mm above finished floor) exit signage would assist all users along exit routes - particularly people who have a mobility impairment.
- Video/data monitors used in the facility should also communicate emergency messages to patrons.

### **3.7.7 EVENT CONSIDERATIONS**

While all above requirements apply generally in usual sporting or social events, any Para sport event will have a much higher population of persons with disabilities than that anticipated by other events.

During Para sport events, the percentage of facility users who may have difficulty traversing sets of stairs or have limitations in responding to emergency signals can be very high. As a result, event planners and operators need to develop customised emergency response plans for the specific event, taking into account these particular facts.

# **CHAPTER 4**

## **ALL ACCESSIBLE ROUTES**



## **4 ALL ACCESSIBLE ROUTES**

### **4.1 INTRODUCTION**

All users rely on pedestrian routes for safe, practical linkages between venues and from venues to transport hubs. If barriers to persons with disabilities are not minimised on the path of travel, then improvements made in the other areas lose their significance.

Pathways, where minimum requirements apply, include, but are not limited to, any route that connects two points within a venue cluster, within buildings, or within rooms inside of venue buildings. The same applies for all routes connecting transport interfaces with buildings, facilities and spaces.

This chapter will provide guidance to ensure all pathways are made accessible.

### **4.2 PATHWAYS**

It is essential to maintain a clear route of travel through a facility that provides a suitable passing width for persons using any mobility device, such as, but not limited to, wheelchairs, scooters, strollers, as well as those traveling in pairs. Also, the route should be free of obstacles for people with vision impairments and those of different heights and size. The width of a hallway varies depending on the planned traffic density of the path. See Figure 14: Pathway widths for the varying pathway widths depending on the density of the traffic. All hallways should allow for turnaround, overpassing or manoeuvring space every **10m**. For specific information about turning spaces, see Section 3.4 Clear floor space.

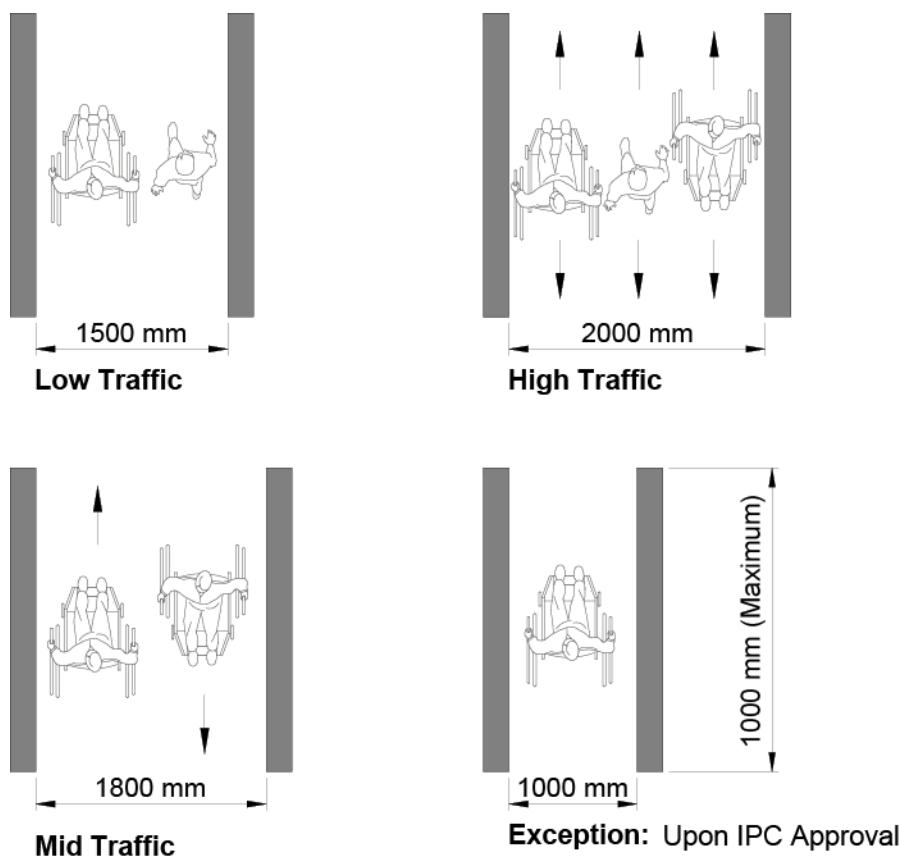

Figure 14: Pathway widths

If the path of travel or any other walkable surface has a gradient perpendicular to the accessible path of travel, the cross slope should not be more than **2%**. For specific information about slopes, see Topic 4.4.1 Slope.

If a slope follows the same direction as the path of travel, reference should be made to the requirements of a ramp described in Section 4.4 Ramp.

**EXCEPTION:** When working with existing structures, hallways should meet the minimum requirement of **1,000mm**. This solution might be acceptable but in the case of the Paralympic Games it must be assessed by IPC, as this solution will not be feasible under all conditions.

### 4.2.1 PATHWAYS REST AREAS

Rest areas along the path of travel are extremely important for many users, including the elderly and people using canes or crutches. It is best practice to provide the opportunity to sit and rest every **50m** along all external paths.

The rest area should also provide the right illumination for people with limited vision or any individual walking along the path. For specific information about lighting, see Section 4.9.9 Directional lighting.

The circulation of the main pathway should not be obstructed by the rest areas. Refer to Section 4.3 Walking surfaces and protruding objects for best practice and pathway circulation requirements.

In addition to standard rest areas, quiet spaces along pathways should be provided for individuals with autism spectrum disorder (ASD). Individuals with ASD may have difficulty processing and integrating sensory information, which can be overwhelming in high-traffic public spaces, such as the Games. Quiet spaces along pathways help provide relief for individuals who feel overstimulated.

### **4.2.2 WAITING AND QUEUING AREAS**

Queueing areas for any purpose should allow all people to move safely and conveniently. Barriers at queueing areas need to allow a clear width of **1,500mm** for each line. The slope of the waiting area should be level or not exceed **1:50 (2%)**.

When the distance is anticipated to be longer than **50m**, or the waiting time is expected to exceed a certain limit, the provision of benches is important for individuals who may have difficulty standing for extended periods.

There should be prominent colour contrast between ropes, bars or barriers to define the queueing areas and the surrounding environment.

## **4.3 WALKING SURFACES AND PROTRUDING OBJECTS**

Pathways and circulation areas should be free from tripping hazards or protruding objects, so that all facilities enable users of any functional ability to encounter a path free of obstacles. Objects that cannot be detected easily by a person with limited sight ability, or by a blind person who uses a cane, can be hazardous.

### **4.3.1 PROTRUDING OBJECTS**

Protruding objects should not obstruct the path of travel. However, if it is necessary to place an object on the path, it should be taken into consideration when calculating the clear space of a route. Objects on the path do not reduce the path minimum width requirement.

Objects protruding into accessible routes with their leading edges between **700mm and 2,100mm** from the floor shall not extend beyond **400mm** into any pedestrian pathways, including, but not limited to, corridors, passageways or aisles. See Figure 15: Protruding objects.



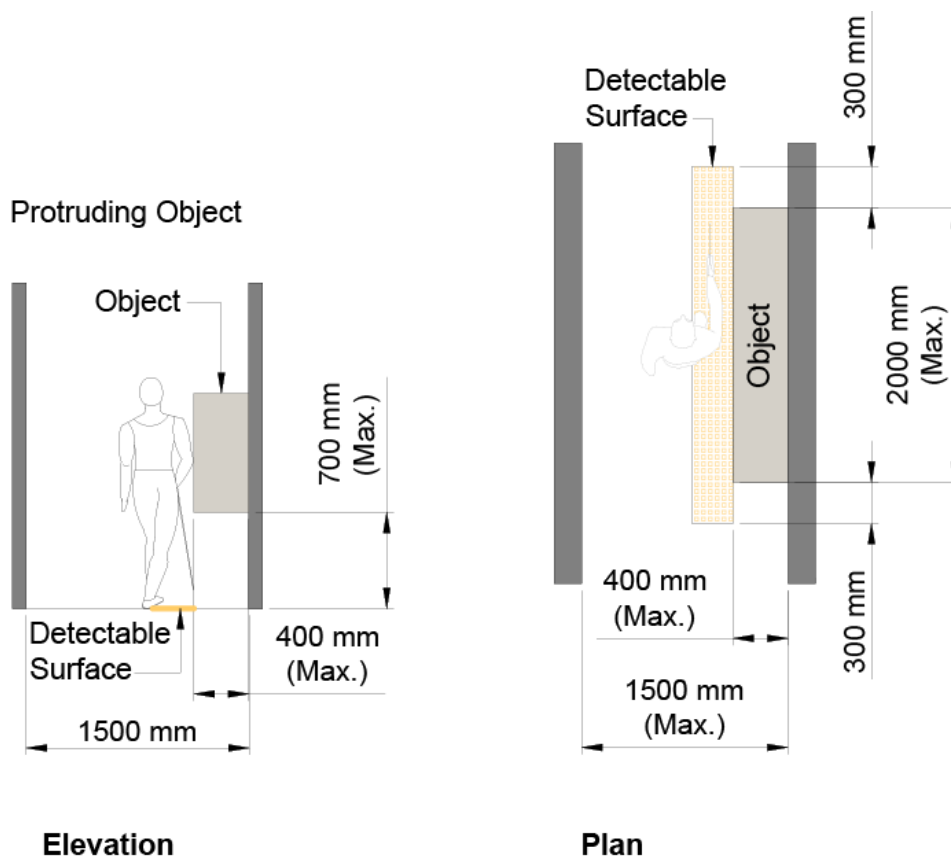

Figure 15: Protruding objects

Protruding objects should also take into consideration low ceilings or under-the-staircase spaces. Clear headroom space of **2,100mm** is required across the entire width and length of the pathway for the safety of all people. If headroom becomes lower than the recommended dimension, a guard must be provided to prevent people trespassing into the lower areas. See Figure 16: Headroom.

**EXCEPTION:** If an object must be placed on the path of travel, the width of the path should not be less than **1,000mm** for a distance longer than **1,500 mm**.

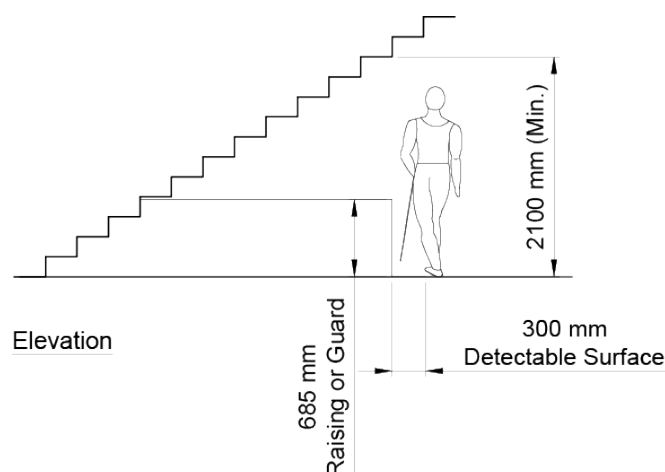

Figure 16: Headroom

Also, a tactile walking surface indicator should be considered when protruding objects are present on the path of travel. They protect and guide people with a vision impairment from running into a hazardous condition. Further information regarding tactile surface and walking indicators can be found in Section 4.9 Signage wayfinding and public spaces .

### 4.3.2 EXTERIOR PAVEMENTS AND FEATURES

Landscaping materials should provide a step-free transition to the pathway along its entire length. Bollards, drinking fountains, and/or other fixed items located on the pathway surface should be in a contrasting colour and be cane detectable. For specific information about water fountains, see Section 5.2 Drinking fountain. Avoid using soft and uneven pavements, such as gravel, or any compound that does not provide a stable surface. It is best practice to use concrete or asphalt on all exterior pathways. Light poles, signs, newspaper boxes, garbage containers, etc., should be kept off the path or, at least, clearly marked with high contrast colour. Portable signage, such as sandwich boards, should not be placed on pathways.

**EXCEPTION:** If the area is existing and no permanent modification will be made to the landscape, it is common practise to use a temporary structure to cover unlevelled areas. This ground covering structure must be stable and hard enough not to sink in the ground in case of water damage or high traffic of people walking.

## 4.4 RAMP

Seamless access without height differences is preferred along any path of travel. If having a height difference is unavoidable, a ramp is the first choice to address a vertical height difference. A ramp allows a wide range of users to have access and move efficiently, including people using a wheelchair, pushing strollers and moving heavy items.

### 4.4.1 SLOPE

The best practice gradient to be used for a ramp is 1:20 (5%) with landings every 10m. Refer to Section 4.4.2 Landings for information about landing specifications and Table 4: Maximum allowable slope of ramps for slope values based on the vertical distance to be covered by the ramp. To fulfil the best practice gradient for a ramp, it means that for every 1cm of height increase, the distance covered by the ramp is 20cm. This design requirement applies to all ramps in newly designed buildings. Following standards for accessible pathways specified in Section 4.2 Pathways, the maximum cross slope of ramp surfaces shall be 1:50 (2%). Refer to Figure 18: Ramp slope and cross slope for additional specifications.

**Table 4: Maximum allowable slope of ramps**

Vertical rise between landings	Maximum slope allowed	Best practice	Variations
0-75mm	1:8	1:12	
76-150mm	1:10	1:12	
151-300mm	1:12	1:14	
301-3000mm	1:14	1:20	A slope of 1:14 might be acceptable for secondary or ancillary facilities.
+3001mm	1:20		Variations to this standard should only be considered on an exception basis.

The minimum width of a ramp between handrails shall be **1,800mm** to allow two wheelchairs to overpass. This is required in ramps longer than 5m or in conditions where a switch back ramp is used. Handrails should be provided in all ramps that exceed **30cm** measured at its highest point to the below connecting surface, see handrail specifications in Section 4.4.3 Handrails.

**EXCEPTION:** If the length of the ramp is less than or equal to 5m, it can be made 1,500mm wide.

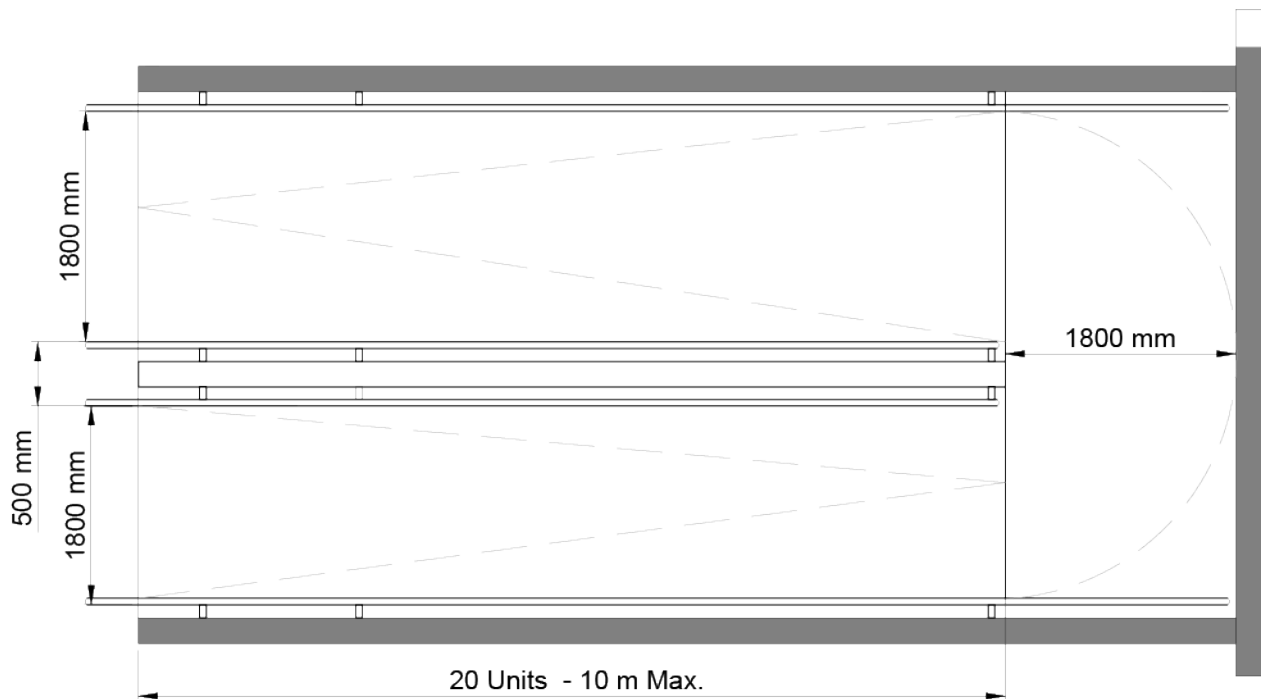

Note:  
Ramps longer than 5m should increase its width to 1800 mm,  
to allow the overpass of two wheelchairs.

Figure 17: Ramps and sloped surfaces

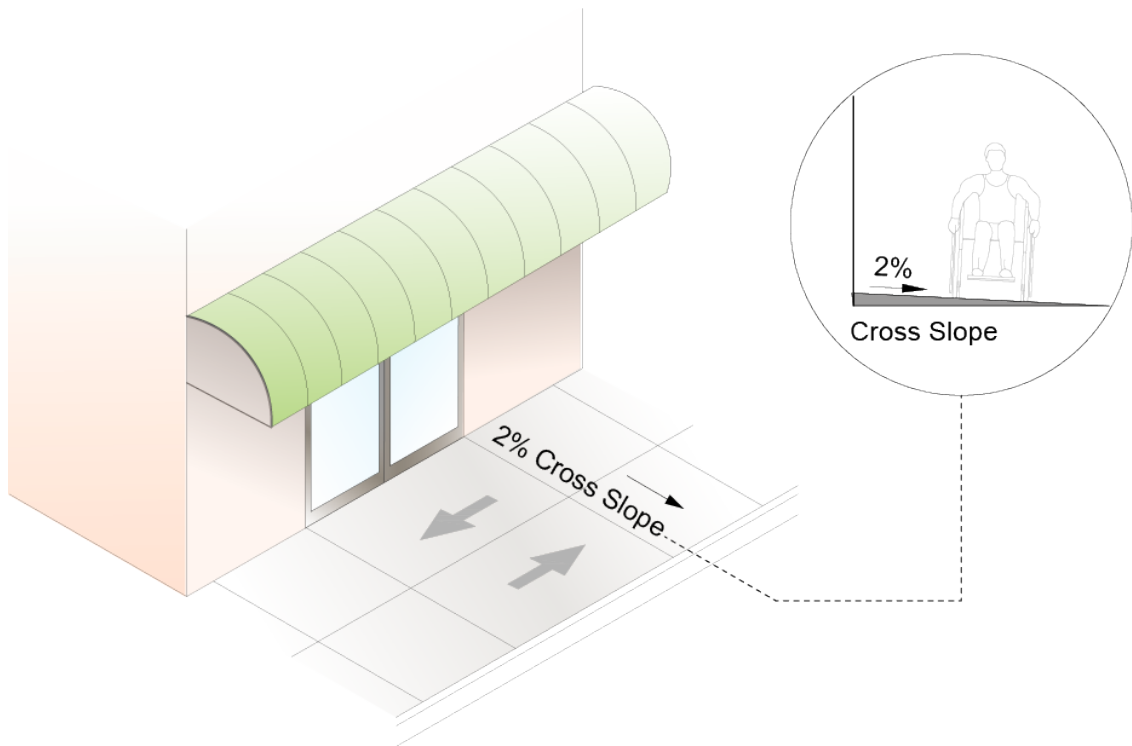
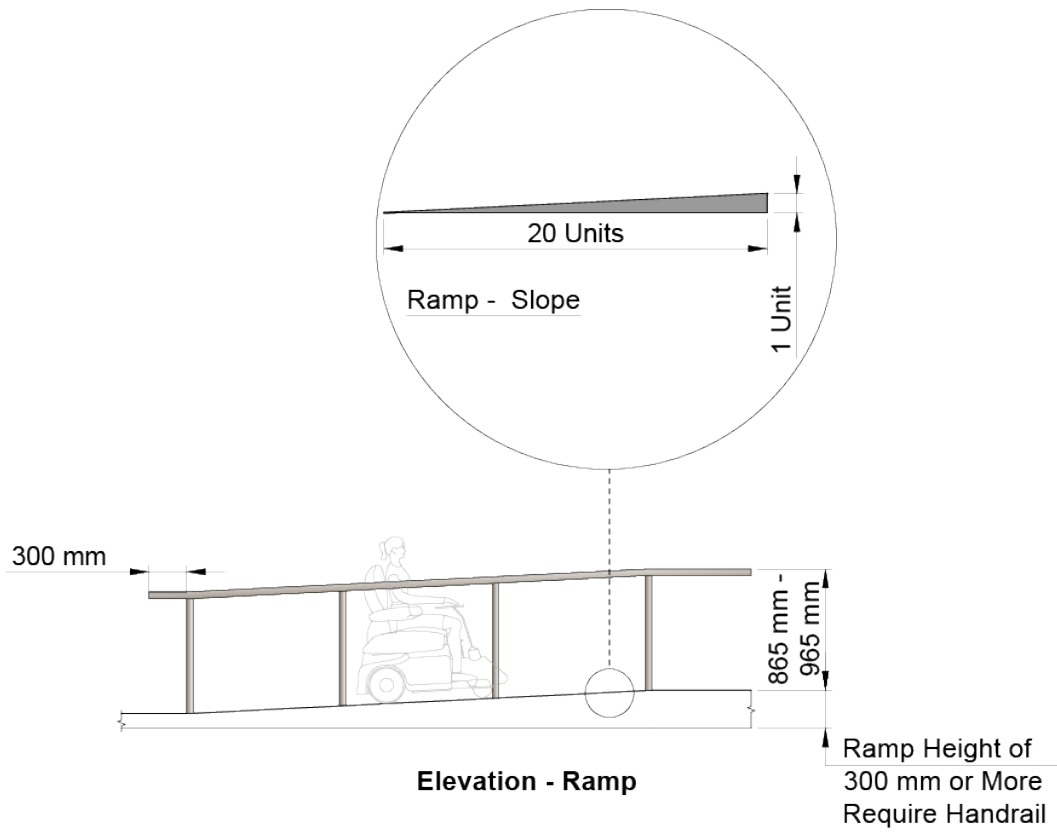

Figure 18: Ramp slope and cross slope

## 4.4.2 LANDINGS

Landings are levelled surfaces that allow a person to rest or find body balance while going up or down an incline path. They should also be placed in front of doors or when an incline path changes direction.

Ramps should provide landings at regular intervals; the interval of the landing is dependent on the slope and length of the ramp.

If a ramp covers a vertical height difference of more than 500mm a landing is required. A new landing is required for every 500mm of vertical height difference the ramp covers. The horizontal length between landing is dependent on the ramp's gradient.

- If the gradient is 1:14, a landing is required every 7m of horizontal length.
- If the gradient is 1:20, a landing is required every 10m of horizontal length.
- If the gradient is less than 1:20, the horizontal length between landings may increase proportionally, but shall not exceed 20m.

Landings are also required when the ramp changes direction. In such cases, the landing should provide at least **1,800mm** turning radius. Landings should be the same width as the ramp connecting to it and should be **1,800mm (min)** in depth.

Handrails should be provided in landings when there is a height difference above **300mm**. See Section 4.4.3 Handrails for further information related to handrail requirements.

A landing is required in front of doors. The landing should consider the requirements of the door clearances specified in Section 3.2 Doors, doorways, and gates.

## 4.4.3 HANDRAILS

Handrails are found in different locations, such as stairs, ramps, platforms, seating bowls and other spaces. Handrails provide a safe route for all users. Handrails are required under different situations, depending on the height or complexity of the conditions. When handrails are required, they must be installed on both sides of the stairway or ramp. See Section 4.6 Stairs, moving walkways and escalators for further information on stairs and Section 4.4.1 Slope for more information related to the relationship of the railing and the ramps. All handrails should:

- Have a cross section according to Figure 19: Handrail cross section to be useful for a wide range of different people.
- Have contrasting colour to their adjoining structure.
- Have a continuous gripping surface without interruptions for posts or other construction elements.
- Have a clear space between the handrail and the wall of **45-60mm**.
- Be mounted between **850-950mm** above the stair nosing.

- Be mounted between **850 - 950mm** above the surface of the ramp following the same angle as the ramp itself.
- Have a continuous inside handrail or, if not continuous, extend at the top of the stairs or ramp parallel with the floor surface at a distance of **300mm** or, if at the bottom of the stairs, continue at slope for a distance equal to one tread and then extend parallel to the floor surface not less than **300mm** and return into wall, floor or post.
- Have a tactile message strip on exit levels of each handrail.

#### Handrails Cross Section

Adults:

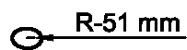
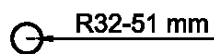

Children / People of  
Short stature:

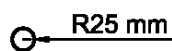

Figure 19: Handrail cross section

## 4.5 KERB RAMPS

A kerb ramp is a graded ramp from the top surface of a sidewalk to the surface of an adjoining street. The maximum slope of a kerb ramp is 1:8 or 1:10, depending on the vertical height it covers (refer to Figure 18: Ramp slope and cross slope). This has been presented in the table about design requirements of a ramp.

Kerb ramps at pedestrian crosswalks shall be wholly contained within the area designated for pedestrian use. The smooth transition and minimal slope of a kerb ramp could go unnoticed by someone with a vision impairment, so textured surfaces are recommended.

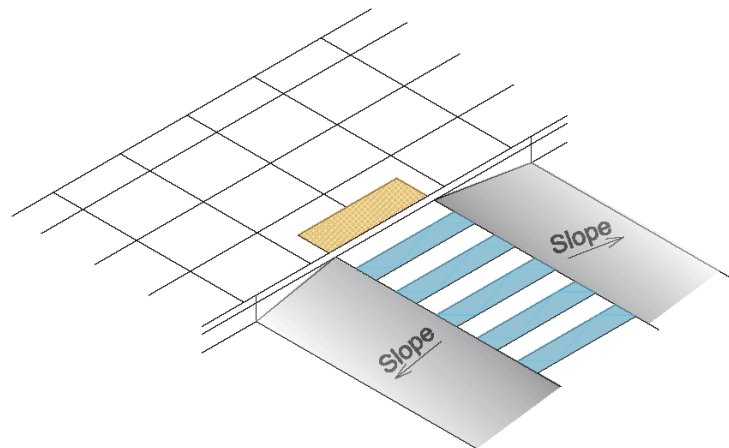

Figure 20: Raised marked crossing

Kerb ramps should:

- Have a minimum width of **1,000mm**.
- Have a slip-resistant surface with a detectable warning surface that is colour and texture contrasted with the adjacent area.
- Have flared sides to eliminate the hazard of pedestrians stepping off an edge. The flared side must have a maximum gradient of **1:10**.
- The following six images describe different kerb ramp conditions. Please note the images are from an overhead perspective.

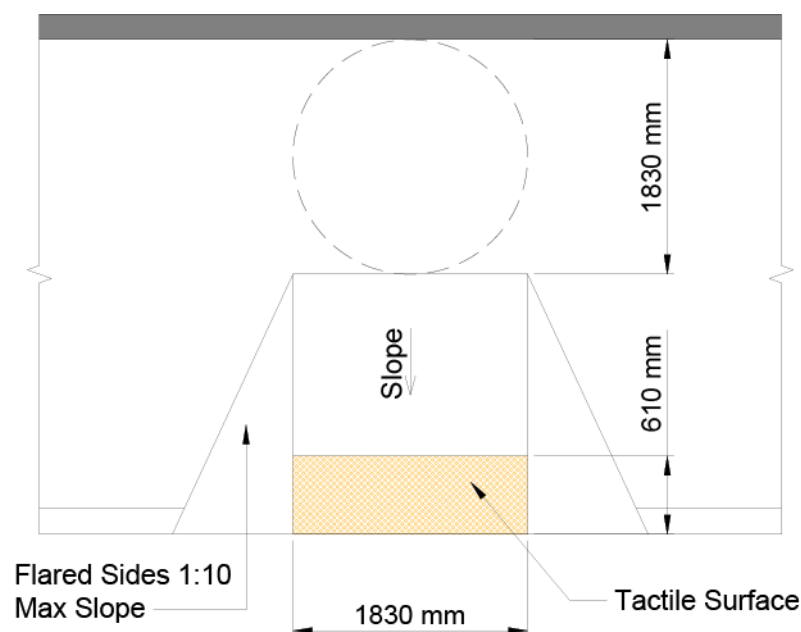

Figure 21: Kerb ramp at mid-block



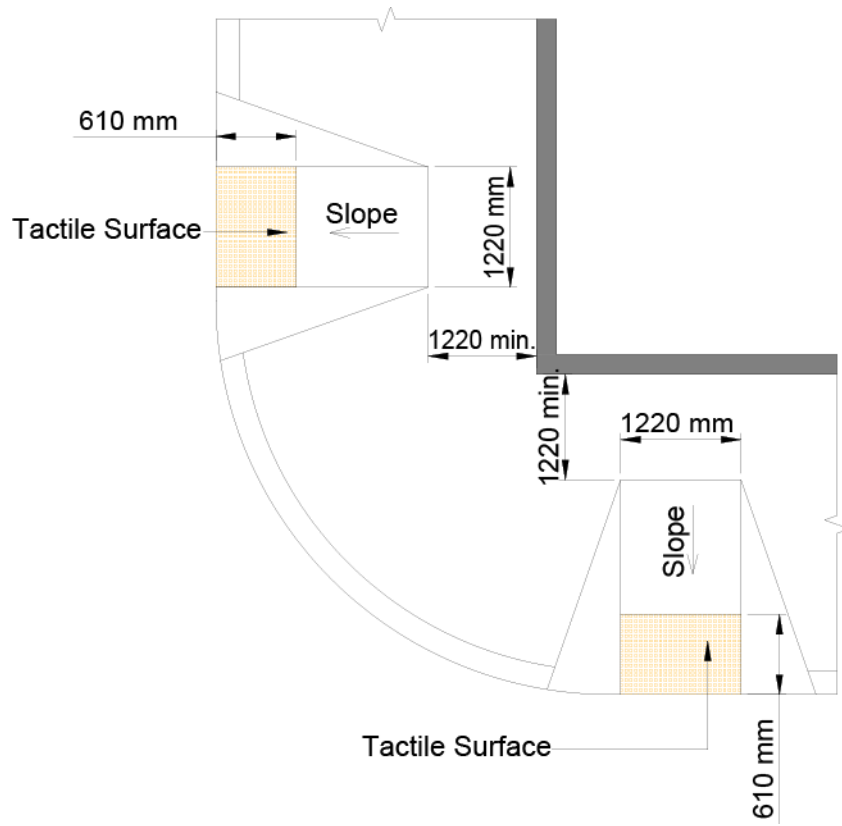

Figure 22: Kerb ramp at corner

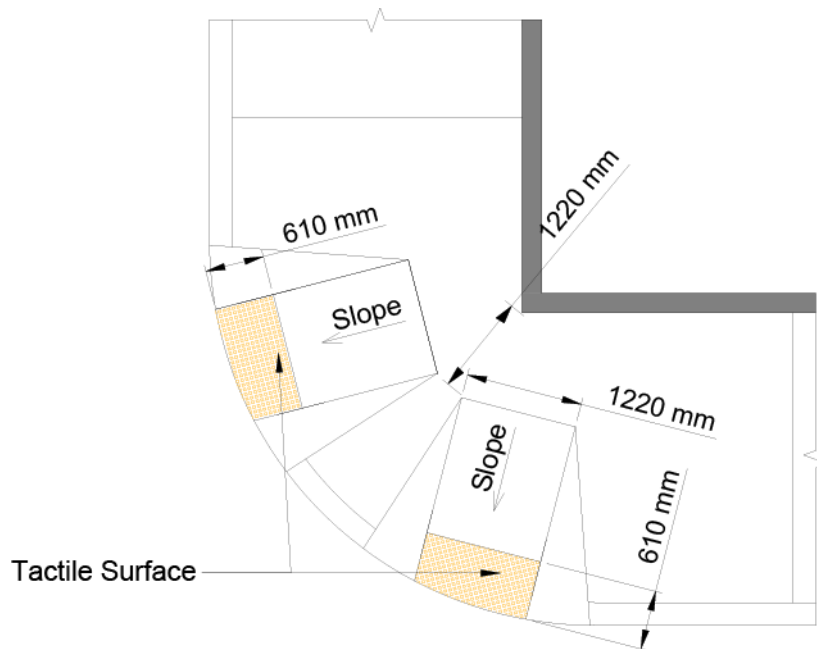

Figure 23: Dual compound kerb ramp at corner

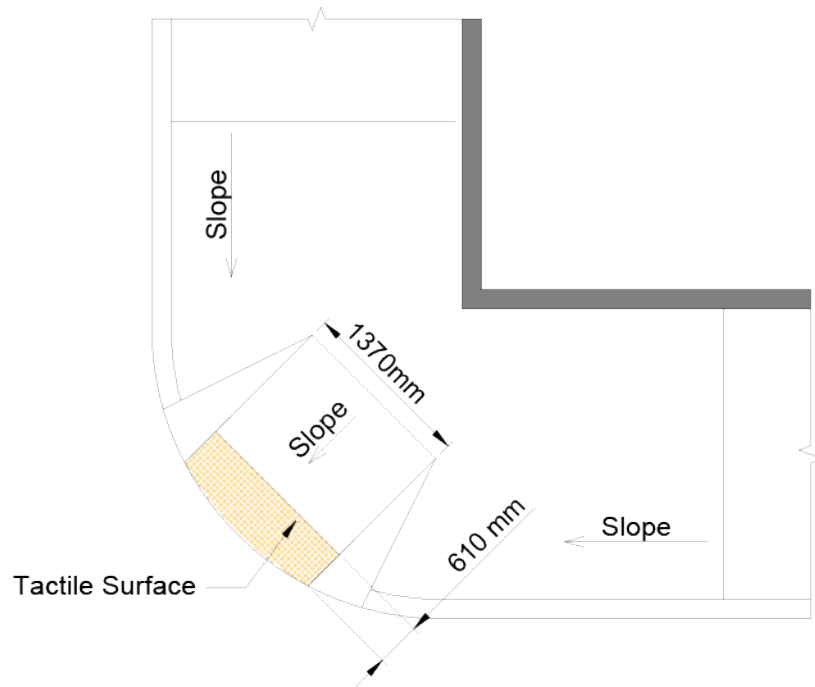

Figure 24: Single compound kerb ramp at corner

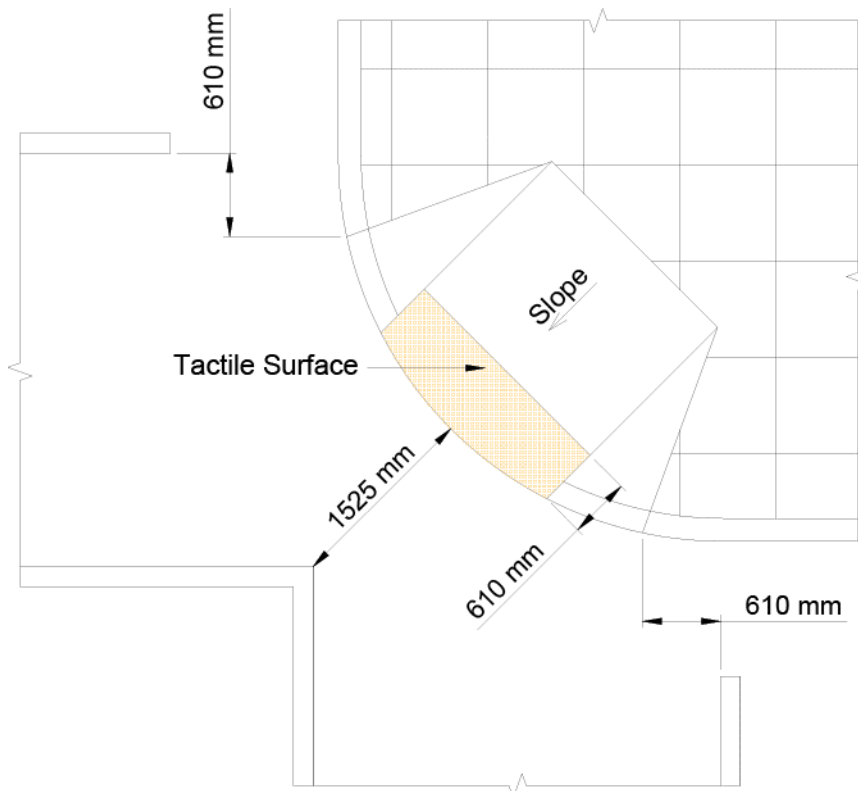

Figure 25: Diagonal kerb ramps

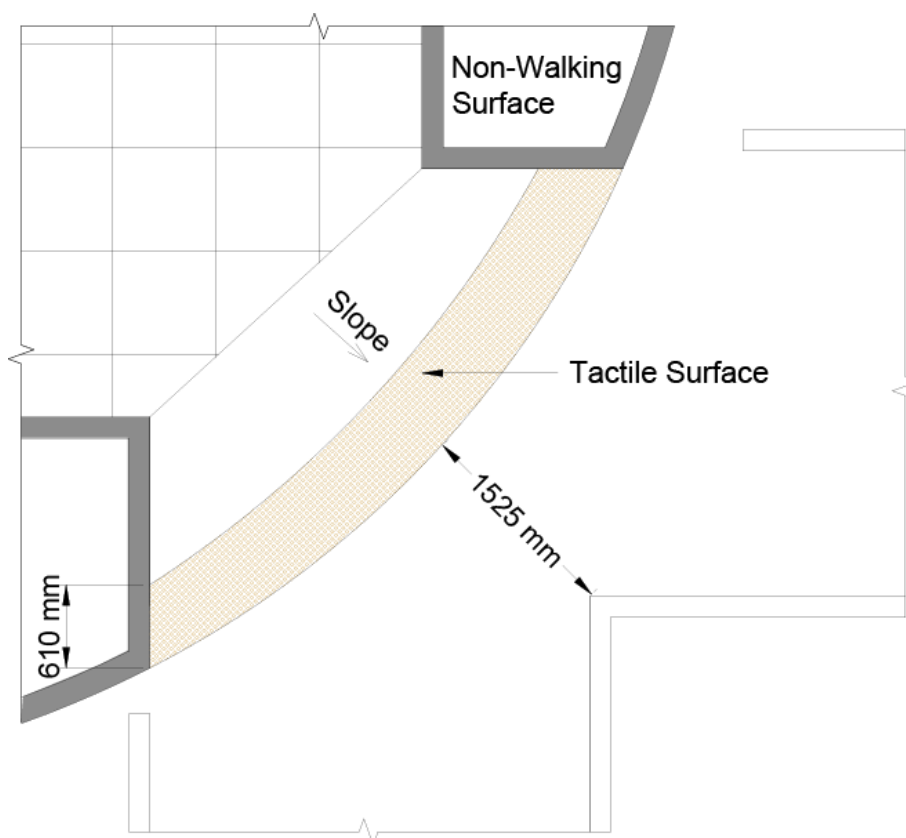

Figure 26: Diagonal kerb ramps

#### 4.5.1 PATHWAYS ADJACENT TO A KERB RAMP

Any road slope adjacent to a kerb ramp should provide a smooth connection to the kerb ramp.

The slope of the routes immediately adjacent to the kerb ramp shall be **1:14 (7.14%) maximum**. It is not safe to transition into a kerb ramp coming from a steep slope; it is very easy for a person in a wheelchair to lose balance and fall out of the chair.

The crossing of any high traffic intersection should be equipped with a pedestrian crossing light and an audio system for the visually impaired. The operating button should be located at a reachable height between **610mm (min)** and **1,220mm (max)**. Any fixtures located at the intersection, such as light posts, trash containers or signs, should not obstruct the accessible path of travel.

It is important to investigate options offered by technology that allow a person to connect their devices to the traffic signal and cars to have a better understanding of the surroundings. The use of this type of system provides a safer environment and improves the experience for everyone.



Photo Credit: United States Department of Transportation

Figure 27: Technology at pedestrian crossings

## 4.6 STAIRS, MOVING WALKWAYS AND ESCALATORS

Stairs, moving walkways and escalators should be made accessible, as these elements are very important when connecting building.

Moving walkways and escalators can be very helpful to alleviate areas of high traffic of people or long walking distances. Certain considerations should be made to ensure these elements are accessible.

In many situations, stairs are the only egress route a building has in case of an emergency. Additional planning needs to be conducted in these instances. For specific information regarding emergency evacuation, see Section 4.10 Evacuation routes.

### 4.6.1 STAIRS

Stairs need to provide uniform riser heights and tread depths. Riser heights should be no more than **180mm** and not less than **125mm** high; best practice is **150mm**. Treads should run no less than **280mm** and not more than **350mm** deep, measured from riser to riser. Closed risers are essential; open risers should be avoided.

Stairs should also provide a landing, which should be the same width as the stairwell and should be at least **1,500mm** in depth.

### 4.6.2 NOSING

The nosing may not project more than **38mm** and should have a high visual contrast to the tread and be of a non-slip material. They need to be illuminated to a minimum level light of **100lux** and have no abrupt undersides.

When projecting, the nosing should be sloped to the riser at less than **60 degrees** angle in relation to the horizontal plane of the tread. See Figure 28: Stair dimensions for further information.

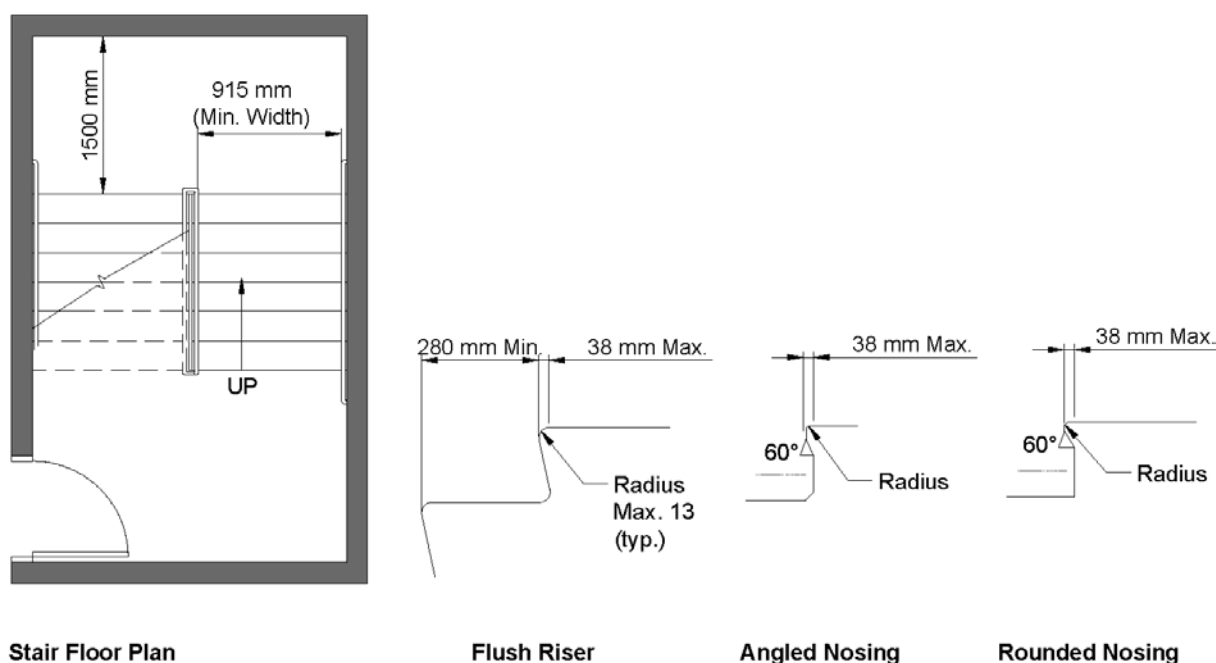

Figure 28: Stair dimensions

### 4.6.3 DETECTABLE WARNINGS

Detectable warnings must be provided at the top of each set of stairs. They should extend to the full width of the stairs for a depth of **600mm** and commence at one tread depth back from the top stair.

The warnings should be of a contrasting colour to the surrounding floor surfaces and detectable by cane. For specific information about changes in surface textures, see Section 4.9.6 Surfaces.

#### **4.6.4 MOVING WALKWAYS AND ESCALATORS**

Moving walkways aid people with limited mobility in reaching their destinations. When providing moving walkways, the following must be considered:

- Moving walkways must be wide enough to accommodate wheeled mobility devices.
- Pathways must provide changes in surface textures as warning surfaces before approaches to moving walkways.
- A motion-sensor should activate the moving walkway as the person approaches and be coordinated with an audible announcement system.
- Audible announcements should notify users when they are approaching entrances and exits of moving walkways and inform the user of which direction the walkways are traveling. The announcement should be specific about the location and direction of the movement of the walkway. The announcement should consider its surroundings in order to be heard but should not be intrusive.

### **4.7 ELEVATORS**

When a ramp or a gradient walkway is not possible, elevators are essential to cover vertical height differences in a building or a facility. Elevators that fulfil accessibility standards shall be identified with appropriate signage. An accessible elevator shall be automatic.

There are three types of appropriate elevators.

- Elevators - service multiple levels and have fully automated operations with accessible control panels.
- Vertical platform lifts - service low risers, i.e., one to two floors or heights above 500mm.
- Stairway platform lifts - service an existing building where space constraints remove the ability to provide an elevator or vertical platform lift.

#### **4.7.1 ELEVATOR DOORS**

Elevator doors shall be power operated and preferably sliding. They shall be provided with a door obstruction sensor device that will function to stop and reopen in case the door is obstructed while closing.

A minimum of six (6) seconds is needed for doors to remain open at any call, except when users use the door open-close buttons in the car.

The car shall be equipped with a levelling device to maintain the floor level to a height not greater than  $\pm 10\text{mm}$ .

The clear width for elevator doors shall be **850mm**, but for elevators serving public spaces and sport facilities clear width of elevator doors shall be at least **950mm**.

### **4.7.2 ELEVATOR CAR**

The elevator car size shall not be less than **1,700mm x 1,500mm**. In facilities with high public use, such as sporting venues, the Paralympic Village residences or entertainment facilities, the size of the car shall not be less than **2,100mm x 1,500mm**.

Lighting levels inside the car should be maintained at ambient hallway light levels of even, flicker-free light and shall not be less than **100lux**.

Elevators should be equipped with handrails that meet the minimum requirements described in Section 4.4.3 Handrails.

Floors inside elevators must be easily recognisable and need to avoid the use of dark floor surfaces which are challenging for people with a vision impairment.

In elevators serving only two floors, flow through design using two doors (one front, one back) is recommended, as this eliminates the need for users to turn around to exit. This is particularly helpful during crowded conditions for wheelchair users, people who have a vision impairment and people using walking aids.

Where flow through designs are not appropriate, a mirror is required on the back wall of elevators to help people with a mobility impairment exit the car in crowded conditions. The bottom edge of this mirror must be no higher than **1,000mm** from the finished floor and extend across the width of the elevator.

Floors need to have a slip-resistant surface. Handrails shall be installed at a height of **850-950mm**. An indicator showing the position of the car as it moves or stops at different floors shall be provided.

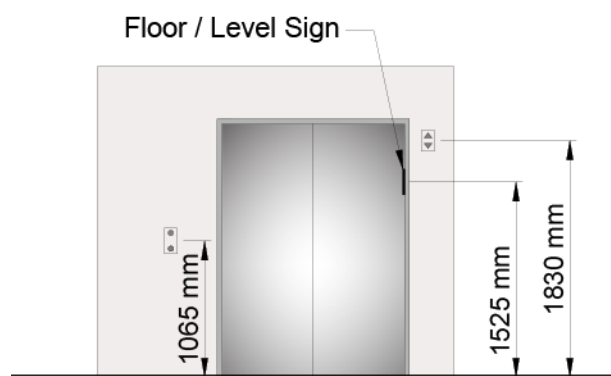

**Exterior Elevation - Elevator**

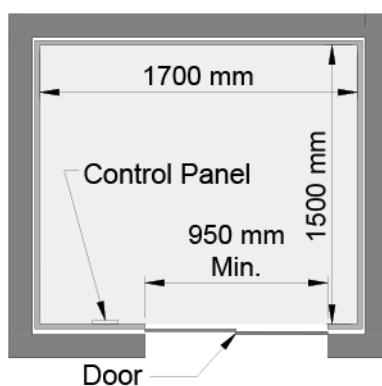

**Interior Plan - Elevator**

**Figure 29: Elevator interior plan**

### 4.7.3 ELEVATOR CONTROLS

Elevator controls must be located on the side wall, approx. **250mm** from the elevator door. This makes it possible for wheelchair users, people of low stature, or those with balance issues to have access to the controls. In cars where two panels are provided, one should be installed on the side wall, the other one should be in the front return panel close to the door. Car controls shall be readily accessible for a wheelchair user upon entering an elevator.

In the control panel the emergency/alarm and door operating buttons shall be located at the bottom of the control panel, at no less than **850mm** from the floor. The highest button in the elevator panel shall be no higher than **1,200mm** from the floor.

Floor buttons in elevator cars shall have at least **20mm** diameter and be raised or tactile. They shall be provided with visual and momentary audible indicators to show when each call is registered.

All car control buttons shall have raised characters for letters and numbers, as well as Braille, placed immediately to the left of, or on, the buttons to which they apply.

Emergency communications using hands-free, intercom systems are required in place of a typical telephone style handset.



Synthesised voice floor callers are required in elevators serving more than two floors, announcing the direction of travelling (up or down) and floor destination of the elevator. These are extremely useful to all users, particularly seniors and people with a vision impairment.

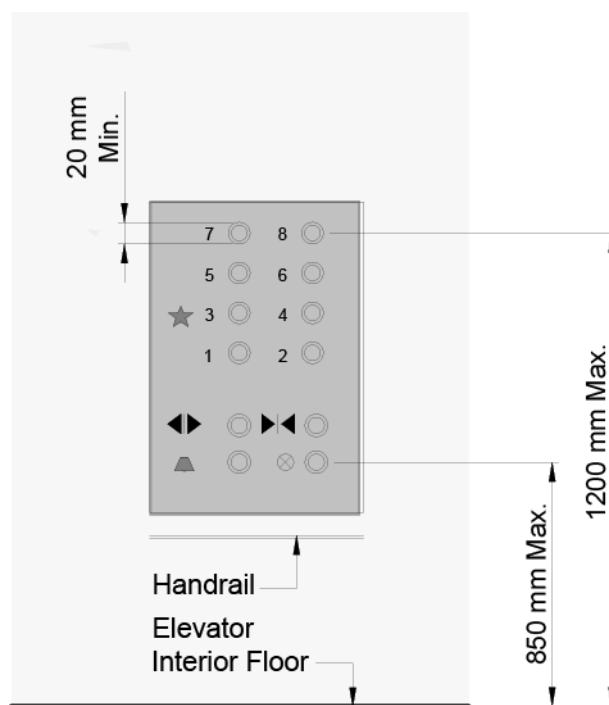

Figure 30: Elevator control panel

#### 4.7.4 OTHER REQUIREMENTS AND CONSIDERATIONS

An audio announcement shall be provided indicating the current floor and direction of travel (up or down) when a) the elevator stops at the landing and b) when the doors open or close.

In the hall leading to the elevator, the control panel shall have the same specifications as the control panel inside the car.

Each elevator shall be equipped with a 2-way communication system, which will be linked to an emergency response system. The highest part of this system shall be at a maximum of **1,200mm** above the floor and shall be identified by a raised symbol or lettering.

If destination-oriented elevators are used, the following should be considered to ensure equal access is provided:

- In addition to touchscreens, keypads should be provided adjacent to all elevator hoist way entrances to ensure that tactile Braille or raised keys are available.
- Passengers must be able to sort through floor levels individually, should they rely on audible feedback.

## 4.8 TRANSPORT LOAD ZONE

Transport load zones must be wide enough to accommodate wheelchair users transferring out of a car and into their wheelchairs safely and comfortably.

The transfer area should be at the level of the road. Transfers into a wheelchair raised up on the sidewalk are extremely difficult and hazardous for many people with a mobility impairment. Cars should be able to park away from the kerbside and an accessible pedestrian route should be identified. The route should connect from the drop-off area to the building entrance or sidewalk and should be protected from car circulation.

Transport load zones also need to accommodate vans and minibuses with rear mounted lifts and side mounted lifts. Additionally, transport load zones need to accommodate high floor coaches fitted with short rise platform lifts.

Therefore, they need to provide an aisle of at least **2,400 mm wide, 7,000 mm long**, and if indoors, a clear ceiling space of 3,300mm min (measured from finished floor to ceiling) adjacent and parallel to the vehicle pull-up space. The minimum light level required for safe vehicle transfers is **60lux**.

To provide an accessible transport load zone, the following infrastructure should be in place:

- Accessible pathway from the facility to the loading/unloading area.
- Waiting/resting seat provision.
- Kerb ramps.
- If a lift or a low bus is used, the drop-off should be on a sidewalk or platform.

The best practice is for a well-constructed, permanent loading bay with plenty of manoeuvring space around it and a kerb ramp offering access onto the sidewalk.

In some instances, temporary transport load zones are created and, in these circumstances, it may be more appropriate to utilise temporary ramps onto the sidewalk. Additionally, there may be no sidewalk close to the transport load zone. In this instance, ensure the pathway surfaces are firm and even. The pathway and the kerb ramp should take into account the high circulation of wheelchairs and should be designed accordingly.

The area must be well lit for night-time/early morning use, and seating must be provided for those waiting for transport who cannot stand for long periods.

## 4.9 SIGNAGE WAYFINDING AND PUBLIC SPACES

Wayfinding is defined as the process that allows people to establish their location, determine their destination, and then develop and follow a plan that will help take them from their current location to their desired destination. A well-designed

wayfinding information system displays information at strategic points to guide people in the direction of their destination.

Wayfinding should be alive and dynamic for everyone. It is important that all users of varying abilities be able to navigate through their built environment. Taking this approach ensures all users can use their orientation, in conjunction with wayfinding principles, to better understand their environment.

Successful wayfinding is informed by a variety of factors, including orientations, spatial planning, signage, and key decision points. Orientation to persons, places, and times influence the first decision that users must make. Based on this preliminary decision, users can then begin to make decisions about spatial planning. When incorporating spatial planning into wayfinding, it is important to keep decision making as simple as possible. To avoid confusing sameness in the user's mind, repetitive information should be eliminated, and a variation of design spaces should be utilised. To ensure that wayfinding is accessible to a wide variety of users, it is important to present information in multiple formats. The best wayfinding aids provide simple audible, visual, and tactile cues.

The basic guidelines for implementing successful wayfinding features within transit stations include the following:

- Develop wayfinding as an integral part of the architecture and site design and not as an afterthought.
- Design the site and facility for clarity of wayfinding:
  - Make stations a recognisable image within the urban fabric.
  - Make entries prominent and easily accessed.
  - Arrange routes so that next destinations are visible whenever possible; for example, being able to see elevators and escalators from fare gates.
  - Recognise that decision points for wayfinding vary among patrons in terms of chosen route and use of some aspects of accommodation; for example, some patrons need to find the elevators while others want to use the escalators.
  - Vary design of spaces to avoid confusing sameness; for example, one station or exit looking exactly like another.

#### **4.9.1 SEQUENCING INFORMATION**

Participants must make a sequence of steps and decisions to reach their destination. For that reason, we can approach wayfinding as a sequence of steps necessary to understand how to reach a location. To begin this sequence, the user must understand both what options are available and what option best suits their needs. Good sequencing information will allow a user to understand how to move through their environment and where they are located as they do. Good sequencing information should aid users in decision making, improve predictability and increase perceived reliability. The following sequencing practices are recommended to aid in decision making:

- Numbered exits and program areas
- Colour coding
- Spacing of signage and key decision point information
- Universal symbols and pictograms

It is critical that sequencing information is organised and continuous in presentation, offers precise communication, language neutrality, and consistency.

#### **4.9.2 PLACEMENT AND DECISION POINTS**

Many factors must be considered before placing signage throughout a venue or facility. When locating signs, the path of travel, information needed, and the visibility of signs must all be measured.

It should also be recognised that signs and multiple wayfinding devices for all users should be integrated throughout the Games. It is important to understand that decision points vary among patrons.

Signage of the International Symbol of Access (ISA) or a modified ISA is required at the following locations:



**Figure 31: Modified international symbol of access**

- Accessible parking spaces
- Accessible passenger loading zones
- Accessible rooms where multiple single-use toilet rooms are clustered at a single location
- Accessible entrances where not all entrances are accessible
- Accessible check-out aisles where not all aisles are accessible
- Family or assisted-use toilet rooms
- Accessible dressing, fitting and locker rooms
- Accessible areas of refuge
- Exterior areas for assisted rescue

Signs should not be placed in a manner that would confuse or obstruct the view of exit signs, traffic signs, signals or devices. They also shall not be placed in a manner that would obstruct any fire escape, window, door or opening that would be used as a means of egress. Signs shall not be attached to a fire escape or interfere with any opening required for ventilation.

Signage should be placed **1,015mm** minimum above the floor of the viewing position, measured to the baseline of the character.

### **Visual cues**

Signage cues usually provide the earliest identification of key decision points. Signage cues help users to direct and orient themselves, find their destinations, and identify their spaces. In addition, signage can be easily updated to inform users of current or future events or activities within the facility. Furthermore, signage acts as an important detectable key in circulation throughout environments.

Developing a standard for signage and wayfinding can help users easily identify important information while navigating this system.

It is important that text and background colours are contrasting, with either dark text on a light background or light text on a dark background. Signs are more legible for persons with low vision when characters contrast as much as possible with their background. Additional factors affecting the ease with which the text can be distinguished from its background include shadows cast by lighting sources, surface glare, and the uniformity of the text and background colours and textures.

### **Landmarks**

Architectural features and destination zones can also act as significant wayfinding cues. Memorable features such as sculptures, monuments and signs can help create orientation points for users that will be easy to recall for further navigational use. Destination zones also provide useful navigational aid by providing central and easy-to-locate congregation and meeting places for users.



Figure 32: Example of a landmark

### **4.9.3 KIOSKS AND MAPS**

There are many cues that can be used as informational access points upon facility entry. Kiosk cues provide multisensory options for users to look up information and find locations. They can effectively convey information in an accessible manner due to the variety of formats in which information can be provided.



**Figure 33: Detailed map kiosk**

Maps provide spatial information which helps the user orient to and navigate within their environments. Maps should abide by the following design principles:

- Organise the environment into distinct spaces by concept or inclusion
- Show all relevant paths, landmarks and districts, but only include significant and notable connections
- Show the user's current position
- Ensure graphic communication is clear
- Use consistent codes of communication
- Avoid alphanumeric coding
- Provide enough information to lead the user to the next wayfinding cue

Accessible kiosks and maps should be located at major decision points, at entrances, and along pathways. Kiosks and maps should be placed so that users with mobility impairments have a path to and from the machine that is free from obstructions. They should be constructed in a manner that allows for either forward or side reach. If operable parts are provided, ensure they are accessible. If a kiosk or map is wall mounted, ensure it does not protrude from the wall or provide cane detection. For specific information about accessible paths of travel, see Section 4.3.1 Protruding Objects. Ensure there is adequate clear floor space in front of the kiosk or map to accommodate a wheelchair user.

#### 4.9.4 PICTOGRAMS AND ICONS

Pictograms are symbolic representations of information using images. When used properly, pictograms are both a clear and concise way to inform users of where they are, the type of routes available, and if these routes accommodate users with a disability. Pictograms move past language and hearing barriers which may present an obstacle for users. This is especially important during a major event such as the Paralympic Games, where many languages are spoken. Pictograms present a simple solution to not only effectively inform users, but also provide universal access to information.



Figure 34: Example of pictograms

Pictograms and signage should be presented in a clear and consistent manner to provide easy user identification. When necessary, pictograms can be used with text to further convey their message. Below are common international pictograms.



Figure 35: Common international pictograms

#### Colours

Colour cues can be used to provide wayfinding assistance while simultaneously being integrated into the aesthetic vision of the facility. Colour cues help to organise facility spaces by providing colour-coded visualization and landmarks. In addition,



colour can affect human emotional response. As a result, it is important to strategically select colours to avoid emotional stress or confusion. Avoid the use of intense warm colours, such as bright yellow, red or orange. Consider contrasting colours.

### Symbol sizes

Symbol size should be the following according to viewing distance:

**Table 5: Symbol sizes in signage**

Distance	Symbol size (mm)
<7m	60 x 60
7-18m	110 x 110
>18m	200 x 200

### **4.9.5 AUDIBLE CUES - BEACONS**

Beacons are small Bluetooth devices that can communicate with smartphones. They can be very useful to blind and vision impaired persons (BVI) because the user can rely on their smartphone application to orient to their environment without the use of sight. There are two primary ways to build beacon infrastructure. The first type of technology is point based, which provides beacons associated with specific objects or rooms. The second type of technology is grid based, in which beacons cover an entire space and create a grid that can recognize the user's position. Both infrastructures can be very useful in helping BVI users to find their destinations.

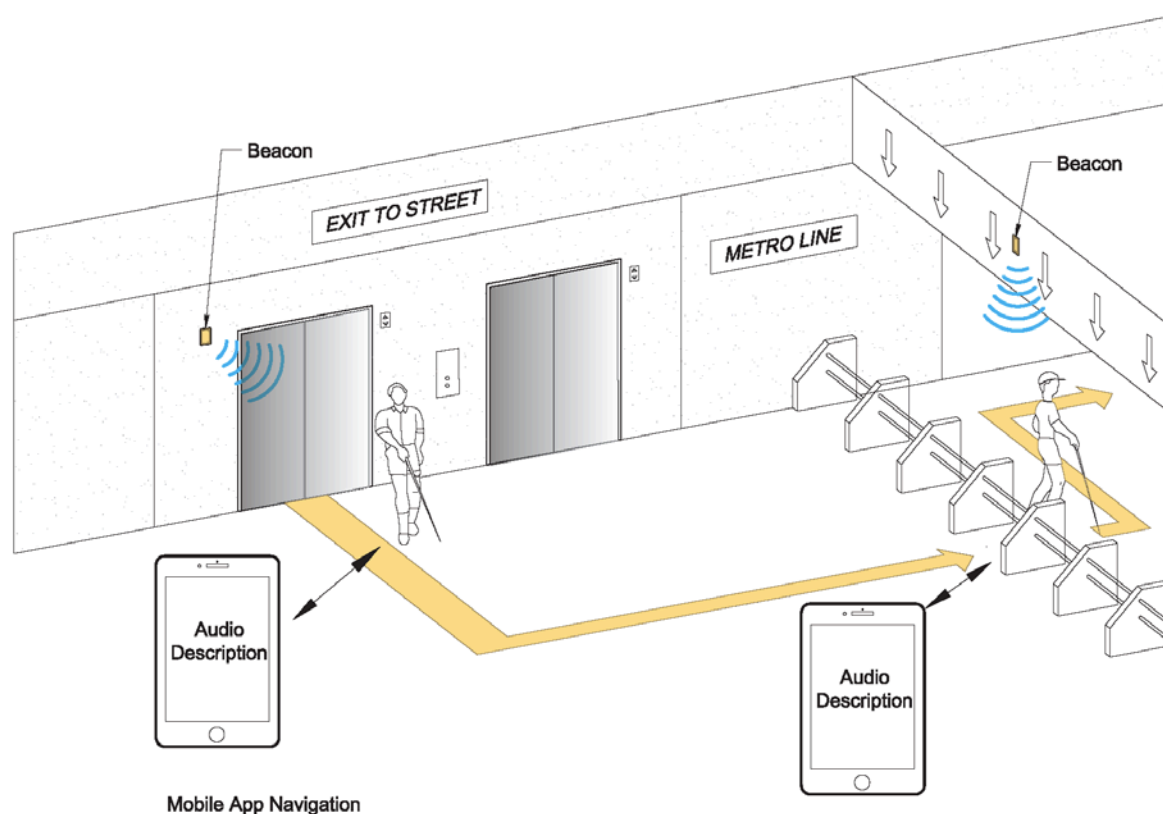

Figure 36: Using beacon technology

#### 4.9.6 TACTILE CUES

##### Tactile signage with Braille

All rooms and program spaces should be identified with tactile signage. Text on tactile signs should be accompanied by Braille. Where tactile signs are required, either one sign with both visual and raised characters, or two separate signs, one with visual and one with raised characters, shall be provided.

##### Tactile maps

Unlike visual maps, tactile maps can help provide BVI users the concept of surroundings. When designing tactile maps, it is important to recognise the intended purpose of the map, as this will influence what to include on the map. Maps should avoid including too much information, as this may be too cluttered and busy for the user to easily interpret.

Labels should be included in both large print with high colour contrast and Braille. Texture symbols should be easy to distinguish both visually and tactually from other area symbols on the map.

A map legend or key should be shown before the map and should clearly display and explain the various colours, textures and visual and tactile symbols included on the

map. Permanently located maps should be in alignment with the four cardinal directions relative to the physical space depicted.



Figure 37: Example of a tactile map

#### 4.9.7 SURFACES

Tactile walking surface indicators help guide all users towards their destinations. They are particularly useful for people with vision impairments.

Tactile walking surface indicators should lead to the most frequent destinations within a particular environment. They should be composed of different floor textures that are detectable by a cane sweep and can be followed like a curb on a street. If more than one tactile surface walking indicator is used, then textures that are easily differentiated from each other should be developed for use along common lengths.

When designing tactile surfaces, at least 50% of colours and tones should contrast with the surrounding surfaces to assist people with a vision impairment who do not use a cane. In addition, all hazards on an accessible route should be clearly marked with a strip of raised, truncated domes placed across the entire length of the hazard and a minimum of 300mm width. Domes should have a base diameter of 23mm minimum and 36mm maximum, and a top diameter of 50% minimum and 65% maximum of the base diameter. Truncated domes shall be 5.1mm in height.

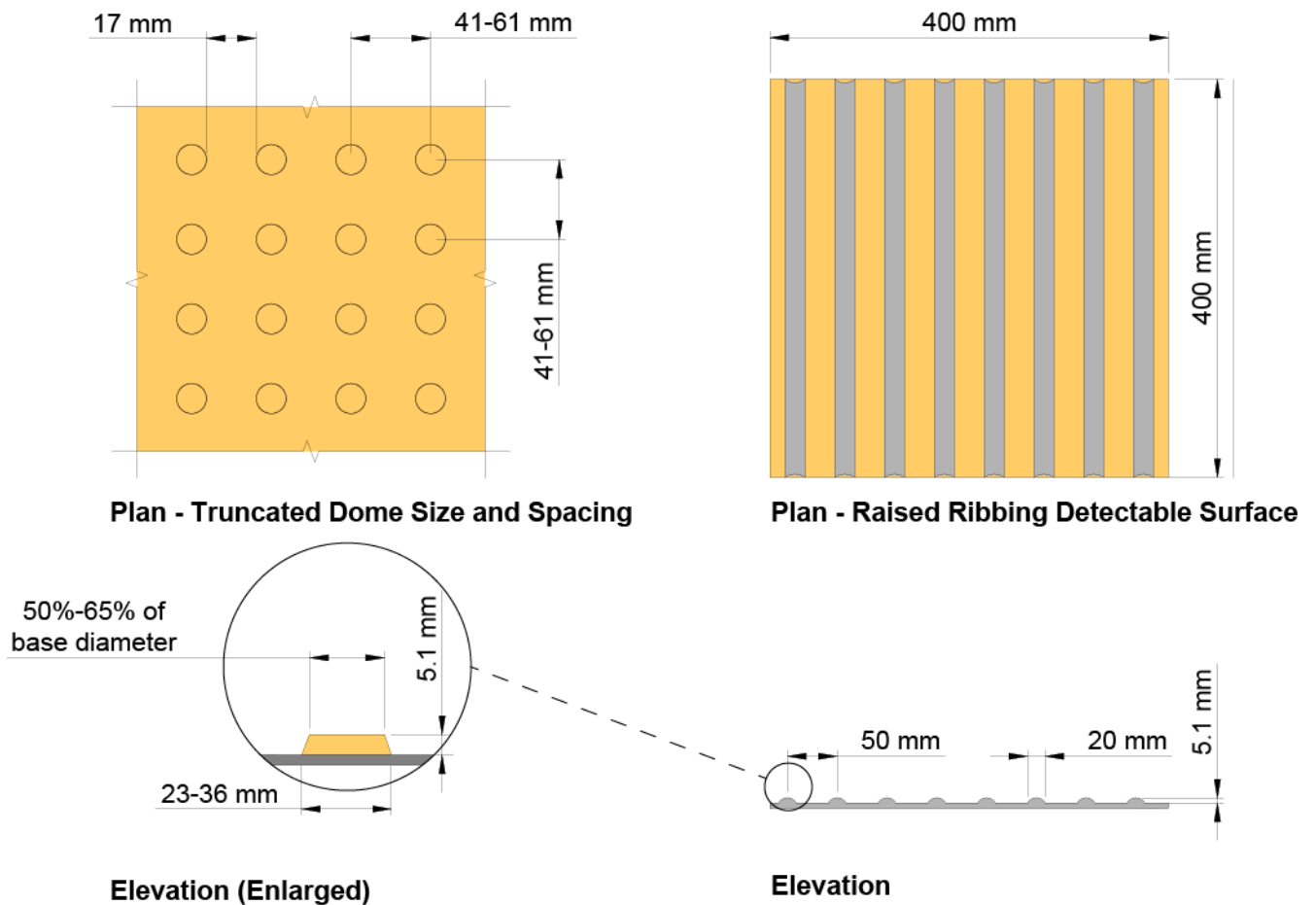

Figure 38: Tactile surfaces

Reflective surfaces and truncated domes as tactile direction indicators should be avoided because BVI users may not be able to differentiate a tactile direction indicator from a hazardous warning. Other tactile materials, such as different flooring materials, may be used as tactile direction indicators.

### Finish materials

Finish materials can also be used as important wayfinding cues. Different finish materials can be useful in differentiating different paths of travel and providing detectable tactile warnings to those with vision impairments.

## 4.9.8 SIGN CONVENTIONS

### Directional arrows

Directional arrows provide vital directional information to users navigating an environment. This system transcends language barriers and helps inform users of major destinations or places of interest. Directional arrows should be used following a consistent standard to efficiently convey information and should be placed at

decision points wherever possible. When used with other signage conventions, directional arrows enhance wayfinding and effectively direct users towards their destinations or pathways. It is recommended that directional arrows are incorporated into signage systems to improve wayfinding and to increase accessibility.

Providing signage that incorporates both directional arrows and pictograms within a system connects users to accessible routes, transportation and their destination. Along the route, wayfinding signage should be repeated to ensure patrons stay the course and prepare for the next move. Using pictograms and directional arrows in wayfinding helps ensure users are informed and allows for users to easily navigate the system, regardless of familiarity.



Figure 39: Using directional arrows with pictograms

### Message conventions

Signs describing pathways, features, and locations should be provided in a clear and concise method that omits any unnecessary information or wording. When using message conventions, such as nomenclature and abbreviations, the following information is recommended:

### Nomenclature

The words used to identify features, functions, and destinations in signage should be consistent across all signs in a system. Prepositions are omitted at the beginning of a message. Example: "Paralympic Games", not "To the Paralympic Games". Either use

the phrase “All Destinations” or list the actual destinations associated with the locations.

### Abbreviations

Use an ampersand “&”, instead of the word “and”, when connecting two words which naturally belong together because of similarity of function or geographical proximity.

### Typeface

Typefaces should be composed of standard sans-serif fonts with easily recognisable upper and lower-case characters. In addition, fonts with medium heaviness should be used. Bold or heavy fonts may be appropriate when emphasizing a word or passage. Complicated and decorative fonts should be avoided. Italic, oblique and script fonts should be avoided. Mono-faced fonts should be used over fonts with proportional spacing.

### Materials

A variety of materials may be used for sign construction. The types and placement of signs should be carefully considered before selecting a material.

It is recognised that materials will vary greatly, depending on if a sign is permanent or temporary. In both cases, materials should be non-flammable, non-fading and vandal resistant to the greatest extent possible.

Materials that require minimal long-term maintenance should be selected. Materials and designs should be standardised and consistent as much as possible. Signs should be built to resist wind, moisture and vandalism to the greatest extent possible. Permanent signs should be built to resist seismic events.

Signs and kiosks should be constructed so that elements can be easily updated. Modular construction can be beneficial to permit graphic panels to be removed and replaced as program spaces are updated.

### Letter sizes

Letter size should be the following according to viewing distance:

**Table 6: Letter sizes in signage**

Distance	Letter size
Less than 3050mm	50mm
3050mm ≤	50mm height plus 5mm per 300mm of viewing distance above 3050mm.

### **4.9.9 DIRECTIONAL LIGHTING**

Lighting can be used to help guide people in a specific direction and identify rooms and objects of interest. The following best practices should be used when considering directional lighting:

- Lighting should be distributed evenly throughout a building to reduce distortion and disorientation. Ambient light should be provided in each room, with preference given to both natural daylight and dimmable fluorescent lamps. Uplighting and downlighting are forms of indirect light which improve indoor illumination.
- The position of lighting should aim to reduce indirect glare on reflective surfaces, as glare can add to eyestrain, headaches and lower the ability to accomplish tasks. Reflective glare can be avoided by carefully placing lighting fixtures away from reflective screens and by using matte finishes for countertops, walls, furniture and signs. Direct glare should be prevented by balancing and controlling daylight in relation to corresponding ambient light. Gradual ranges in light levels can help control direct glare.
- Luminance contrast is preferred to colour contrast alone. Luminance contrast is seen when two adjacent areas differ in the intensity of light reflected or emitted from them. Luminance contrast can be very helpful for people with a visual impairment to locate important features such as doorways, signs, hazards and objects of interest.

## **4.10 EVACUATION ROUTES**

Emergency response plans need to consider potential users who have mobility, sensory or cognitive limitations and provide adequate solutions for them. In the event of fire when elevators cannot be used, areas of rescue assistance must be available to anyone who would have difficulty traversing sets of stairs.

### **4.10.1 EMERGENCY EVACUATION**

Routes acting as 'emergency evacuation routes' need to comply with accessibility standards described in Chapter 4 All accessible routes.

Routes acting as immediate egress to an open and safe area must encompass a barrier-free path of travel to an exit.

### **4.10.2 AREAS OF RESCUE ASSISTANCE**

Areas of rescue assistance shall be provided in all cases where immediate egress to an open and safe area is only available by using stairs during an emergency situation.

These areas should be located on an accessible route and have a minimum size of **850mm x 1,300mm** per anticipated potential user. In the case of Para sport events it is critical to have a very detailed rescue plan as there will be large number of people requiring special assistance. It is recommended that the assigned smoke- and fire-free compartment of the building is not only in the stairwell but in the core of the building.

Some provisions are essential:

- Signage should be provided at a height between of **1800 mm** and **2000mm**. The signage lettering should be of high contrast and tactile lettering.
- All doors should swing into the area of rescue to allow for easy access. All doors should comply with the recommendations of Section 3.2 Doors, doorways, and gates.
- Entry doors should be of a contrasting colour to the surrounding surfaces.
- Provide a hands-free intercom or other communications device.
- Provide proper awareness training to staff on the appropriate use of this area.
- Exit stairs should be equipped with glow-in-the-dark, stair nosing or handrails.



# **CHAPTER 5**

## **WASHROOMS AND OTHER PLUMBING ELEMENTS**

# 5 WASHROOMS AND OTHER PLUMBING ELEMENTS

## 5.1 INTRODUCTION

When designing a building, one of the most critical areas to monitor to ensure accessibility is plumbing elements such as toilet compartments, showers and water fountains. This chapter details the minimum requirements necessary to provide accessible plumbing fixtures usable by all.

## 5.2 DRINKING FOUNTAIN

As communities seek to move away from single-use plastic, public drinking fountains are becoming more prevalent. Drinking fountains must be designed and placed taking into consideration the difference in the users, such as a person standing and a person seating or those with short stature. It is also important to consider the location as they should be visible, but they must avoid obstructing the path of travel, especially in high traffic areas. Some of the best practices are described below:

- A drinking fountain intended for a person standing should be located with the spout **1,050mm** above the finished floor and approximately **150mm** clear from the wall.
- A drinking fountain for wheelchair users or people of small stature should be located with the spout **900mm** above the finished floor and approximately **380mm** clear from the wall. It should also allow for side approach and provide a clear circulation area.
- The spout positioned further away from the wall allows knee recess space for a wheelchair user to move close enough to the spout for easy use.

## 5.3 TOILET COMPARTMENT AND CUBICLES

Accessible toilet compartment and bathrooms are essential for providing an adequate service to all clients during any sporting event. The layout or design, and the number of accessible bathrooms provided, are two of the main factors to consider while organising any major event.

It is important to pay close attention to the bathrooms and consider making them as universally designed as possible. Depending on the circumstances, some people with a disability require full-time assistance to complete almost all tasks. Thus, in certain places it is recommended to provide a gender-neutral bathroom that includes shower and toilets. Some of the minimum requirements are listed below.

- Although it is important to always provide a gender-neutral accessible toilet, both the men's and the women's toilets should also provide accessible features.

- It is good practice to provide at least one accessible cubicle in both the men's and women's toilets. This will significantly increase toilet capacity, especially for those wheelchair users who can manoeuvre within tight spaces and of course ambulant people with any kind of disability.
- In large venues it is recommended to provide one accessible toilet for every 15 clients with a mobility impairment. This number is usually calculated using the number of accessible seats provided in the venue.

The enlarged cubicle is necessary to assist ambulant people with a disability, people with babies or with small children, and/or people with large bags.

Enlarged accessible toilet compartments/cubicles should consider the following points.

- In all men's and women's toilet blocks, provide an enlarged accessible toilet compartment/cubicle.
- The interior of the cubicle should provide a clear turning radius of **1,500mm** which does not overlap any of the plumbing fixtures, such as toilet and sink.
- The outward swinging door should offer a clear width of at least **700mm** and not overlap any of the clearances of the plumbing fixtures.
- The toilet pan must be served by at least one vertical handrail which is **600mm** long, located with the centre line positioned **1,200mm** above finished floor level.
- The toilet pan must also be served by a horizontally-positioned grab rail located on the adjacent wall.
- All grab rails should contrast in colour with its background.
- The location and placement of all accessible features should follow the recommendations found in Figure 42: Bathroom fixtures schematic and Table 6: Bathroom fixtures measurements.

### **5.3.1 TOILET AND URINALS**

Although it is important to always provide a gender-neutral accessible toilet for persons with disabilities (especially wheelchair users), both the men's and the women's toilets should also provide accessible fixtures.

The men's bathroom normally has urinals which significantly increases toilet capacity. Accessible urinals should be usable by wheelchair users and ambulant people with a disability. Accessible urinals often provide good access for children and people of small stature.



Figure 40: Accessible urinals

The following design guidelines should be taken into consideration when designing an accessible urinal:

- In all men's bathrooms provide at least one accessible urinal.
- Accessible urinals must have an elongated bowl with the top of the rim no more than 400mm from the finished floor level.
- The accessible urinal must have a contrasting colour in relation to its back wall.
- There should be a clear space in front of the accessible urinal offering **760mm** clear width and the space **1,220mm** long.
- Vertical grab rails **600mm** long should be positioned either side of the accessible urinal.
- Each vertical grab rail should be positioned so that its centre point is located 1,200mm above the finished floor level.

### 5.3.2 GRAB BARS

The use of grab bars is common not only for people with mobility impairments but also the elderly, as well as people who need some help to find better balance under different conditions.

Grab bars are required in toilet compartments, showers and tubs. During the Paralympic Games, every accessible bathroom should provide grab bars in toilet and bathing compartments. The location of the grab bars is critical for its functionality. Refer to Figure 42: Bathroom fixtures schematic and Table 6: Bathroom fixtures measurements for specific information.

**EXCEPTION:** Accommodation for a major sporting event like the Paralympic Games is a challenge for many hotels and the athlete village since it is practically impossible to make every room fully accessible, so a wheelchair friendly room is created where many of the features are usable by some people with a disability but not all. In the case of a wheelchair friendly room it is common to use a temporary grab bar. Please see Figure 41: Temporary grab bar and Section 6.6.3 “Wheelchair friendly’ guest room for greater details.



Figure 41: Temporary grab bar

### 5.3.3 LAVATORIES AND SINKS

Lavatories and sinks should be made accessible to all users. Due to the high demand during a Para sport event, it is best practice to provide universal height sinks. Refer to Figure 42: Bathroom fixtures schematic for reference.

- Sinks should provide enough space in the front to be approached. The ability to have a front approach and side approach to access the fixture should be considered best practise. Refer to Section 3.5.2 Reach ranges for further information on the different types of approaches and the minimum space requirements.
- The sink tap controls should be placed within reach of a person in a wheelchair or with limited mobility. They must be placed **430mm** distance from the edge of a free-standing sink or sink countertop.
- A hands-free automatic tap is preferred. The minimum requirement is for a single, thermostatically controlled and lever-operated tap. Separate controls for hot water and cold water should be not used.
- Accessories such as soap dispenser and paper towel should be located within the reach range specified in Section 3.5.1 Reach ranges.
- Ensure that garbage can placement does not block access to the paper towel dispenser, or the required **500mm** pull space beside the exit door.
- It is good practice to provide a small removable step in front of one of the sinks to provide a good access for people with lower stature or children.

### 5.3.4 SHOWER AND WATER CLOSET

In some instances, a combination of a shower and a toilet are the best option to provide an accessible toilet and a shower or changing space for wheelchair users. The combination of shower and water closet provides a more spacious and private environment than locker rooms can usually provide. This is also recommended for persons with disabilities who require the assistance of another person. The room should provide accommodation for a shower, toilet and changing station.

The room must meet all minimum requirements described in Section 5.3 Toilet compartment and cubicles and Section 5.4 Shower and tub, and should include the guidelines described below.

- A toilet with front and side transfer approach should be provided. Refer to Figure 11: Side and front approach for further information.
- A shower should be provided with a shower bench. It should be approachable from the side and free of steps.
- An emergency button should be located within reach range near the toilet and the shower.
- A sink should be provided with front and side approach.
- A changing table should be provided between 500mm-580mm height.
- A full body mirror should be placed to allow any person look into the mirror. The location of the mirror should be free of obstacles for people with mobility impairments.
- Hand dryer and paper towels should be placed at **1,000mm** height.
- Toilet paper should be placed between **350mm** and **450mm** at **100mm** maximum away from the edge of the toilet.
- All grab bars should comply with the minimum requirements described in Section 5.3.2 Grab bars. Bars should be placed around the toilet, but they should not hinder the ability of a person to transfer, according to the different approach described in Section 3.5.2 Reach ranges.

For additional information refer to Figure 42: Bathroom fixtures schematic and Table 6: Bathroom fixtures measurements.

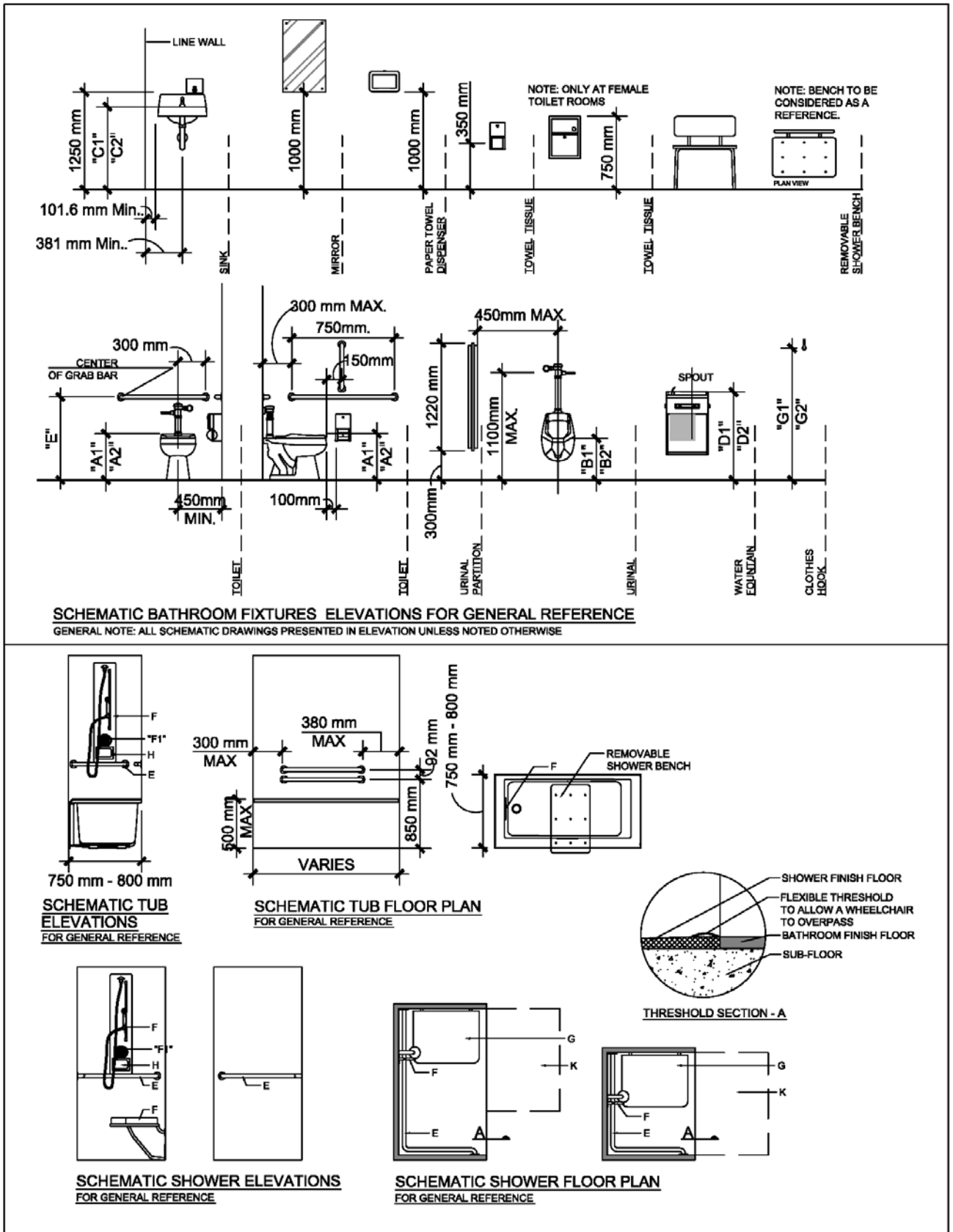

Figure 42: Bathroom fixtures schematic

Table 7: Bathroom fixtures measurements

Bathroom Fixtures Heights Reference		
Designation	Description	Dimension
"A1"	Toilet seat height	450mm - 460mm
"B1"	Urinal rim	450mm
"C1"	Lavatory rim (max) height / (min) clearance below	790mm / 750mm
"C2"	Lavatory rim	790mm - 810mm
"D1"	Accessible drinking foundation	Spout outlet shall be 900mm min. and 1090mm max. above finish floor or ground
"D2"	Drinking foundation	Spout outlet shall be 970mm min. and 1090mm max. above finish floor or ground
"E"	Horizontal grab bar height	840mm - 910mm
"E1"	Vertical bar height bar (measured from the lowest end or the finish floor)	670mm - 680mm
"F"	Shower head height	1000mm max.
"F1"	Shower controls height	750mm
"G"	Shower bench height	440mm - 460mm
"H"	Dispenser height	430mm - 1220mm
"J"	Accessible clothes hook	1120mm
"J2"	Clothes hook	1200mm

## 5.4 SHOWER AND TUB

When designing a locker room or any space that requires a shower space, it is important to consider the different minimum requirements to provide a space usable by anyone regardless of disability.



### 5.4.1 SHOWER

It is generally recognised that for many people with a disability, accessible showers are required. The most important element is to ensure there is enough space to manoeuvre into the shower area and onto the shower seat. Refer to Figure 43: Portable shower chair and Figure 44: Wall mounted shower chair for examples of shower chairs.



Figure 43: Portable shower chair



Figure 44: Wall mounted shower chair

Additionally, the shower must be of a “wet room” design so that a wheelchair user can roll into the shower itself and transfer onto a shower bench.

In all hotels (including the Paralympic Family Hotel), Athletes Village and athlete changing areas, ensure there are a number of wet room showers available for use. For specifics regarding Paralympic considerations during the Games, see Chapter 7 Olympic and Paralympic Games Specific Guidelines.

Minimum requirements should be taken into consideration when designing a shower room. See Figure 42: Bathroom fixtures schematic and Table 6: Bathroom fixtures measurements for all measurement requirements of the elements described below:

- Never install shower trays unless they are imbedded in the slab and provide a seamless transition from the floor into the shower tray. Provide a “wet room” style shower facility.
- The floor of the shower room or compartment should slope gently towards a gulley or drain.
- Install emergency pull cords extending almost to floor level.
- The floor should be slip resistant.
- A full-length safety mirror should be provided set **300mm** from the floor.
- Coat hooks should be provided between the height of **1,200mm** and **1,800mm**. This allows for items to be easily reached from the shower bench.
- A towel rail should be positioned at a height of **1,000mm**.
- Provide a selection of equipment for use in the shower, including rubber bathmats, stand-alone shower chairs, and additional grab rails.

**EXCEPTION:** Some persons with disabilities, particularly ambulant people with a disability, may be able to use a shower cubicle featuring a shower tray. In this case, consider providing additional grab rails.

If the expected use of the bath is for a person with a disability who DOES NOT use a wheelchair, the provision of specialist equipment becomes even more important and could additionally include tap turners or a stand-alone shower seat.

### 5.4.2 TUB

It is generally recognised that for many people with a disability, accessible showers are required. However, some people with a disability prefer a bath and for others (particularly athletes) a hot or cold bath is necessary. For many sporting events, including the Paralympic Games, the installation of a shower is recognised as best practice and a tub considered as user-friendly. For measures related to the element described below, see Figure 42: Bathroom fixtures schematic and Table 6: Bathroom fixtures measurements.

- In all hotels (including the Paralympic Family Hotel), Athletes Village and athlete changing areas, ensure a number of bathtubs are available for use.
- The most important element is to ensure there is plenty of space to manoeuvre by the side of the bath and that a range of equipment is provided, such as bath seats to facilitate easy independent use.
- Ensure there is at least a **1,200mm** turning circle by the side of the bath.
- Ensure the floor service close to the bath is slip resistant.
- Ensure a transfer space is provided at the foot of the bath (opposite end to the taps).
- Ensure this transfer space is at least **400mm** deep and covers the full width of the bathtub.
- Provide a diagonally-fitted grab rail to the wall next to the transfer space.
- Lever controls should be used on all taps and located in an easy-to-reach position.
- Provide a handrail along the full length of the bath, fitted **150mm** above the top of the bath rim.
- Provide a selection of equipment for use in the bath, including rubber bathmats, bath chairs and seats, slatted bath boards, bath cushions, and bath steps. Also, tap turners should be included if the bath tap is not already fitted with a lever mechanism.

**EXCEPTION:** In existing facilities, it may be difficult or impractical to provide the transfer space at the foot of the bath. In this instance, the bath may be more suitable to be used by a non-wheelchair user and should be allocated accordingly.

Additionally, if the expected user of the bathroom is not a wheelchair user, the **1,200mm** turning circle may not be required.

## 5.5 LOCKER ROOMS

Venue locker rooms are a very important space as they provide the preparation area for the athletes. Different sports have different needs inside this space, so the design of a locker room should be versatile and allow flexibility. However, there are some references applicable to many venues and sports.

In instances where the locker room will be used for team sports, the space should allow for several wheelchairs to circulate inside. The best way to guarantee a free circulation is by providing flexible benches that can be removed or relocated within the space.

### 5.5.1 LOCKER DESIGN

The design of lockers should take into consideration accessibility parameters so they can be used by any athlete regardless of disability. Some of the characteristics are:

- Locker door handle should be placed between **610mm** and **1,220mm**.
- A hanger rod must be placed within reachable range for a person to have access from a seated position. A hanger rod for a person standing should also be provided. See Figure 45: Locker interior elevation.
- The locker should be easy to access, without having any obstacles such as benches in front. There should be enough space to circulate and operate the doors.
- Benches should be relocated to provide better circulation for wheelchair users, but they should not be completely removed as they will still be used for changing or support.

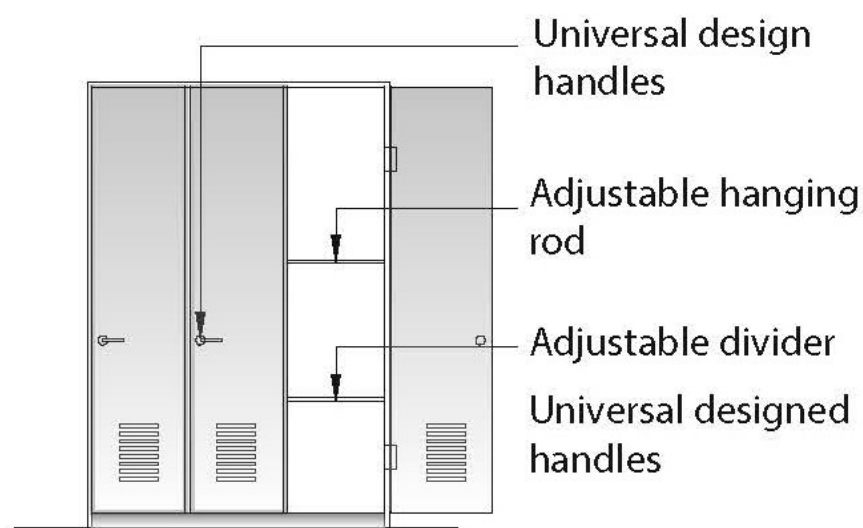

Figure 45: Locker interior elevation

### 5.5.2 PRIVATE CHANGING SPACE

Another area to consider inside the locker rooms is the private changing spaces. This is very useful for people with a disability that require the help of another person to change or need a transfer space to get ready. Some of the minimum requirements to consider when designing this is space are:

- Private changing spaces should provide a bench and enough space to circulate. See Section 3.4 Clear floor space for further information related to clearances and circulation.
- An accessible hanging rod and a mirror are elements that can improve the usability of the space.

### 5.5.3 COMMON SHOWER SPACE

It is standard practice to provide communal shower spaces in locker rooms. Although they are open and obstacle free, many times they can be very uncomfortable for people with mobility impairments who require a wheelchair, a walker or use prosthetics. These spaces are often very wet, and the splashing of water can be harmful for mobility equipment.

It is important to consider some of the following design parameters when designing a common shower space:

- Locker rooms should provide at least one accessible stall.
- The accessible stall should be step free.
- The shower space should provide a transfer space onto a bench and a rotation space within the shower space.
- The shower space should have a curtain that prevents the mobility device from getting wet.
- The space should meet the minimum requirements described in Section 5.4.1 Shower.

## 5.6 LAUNDRY ROOM

During Games-time, athletes, Games Family and volunteers could be away from home for a long period. It is important to ensure facilities for washing and drying clothes are as accessible as possible.

### 5.6.1 WASHER AND DRYER

When washing machines and tumble dryers are provided, the best practice is to ensure that at least 1 (or 10% of the total number of) machine(s) are accessible based on the following guidelines:

- Washing machines and tumble dryers are front-loading machines.
- All controls should be within reachable range. See Section 3.5 Reach range, knee and toe clearance for further information related to reach range.
- Washing machines or tumble dryers to be located on a plinth to raise the centre of the door opening to **600mm** above finished floor level.
- Ensure all washing machines and tumble dryers provided have control panels and operating buttons no higher than **1,200mm** above finished floor level.
- Washing machines should provide a clear passageway no less than 1,000mm when the machine door is open. See Figure 46: Washing and drying machines.

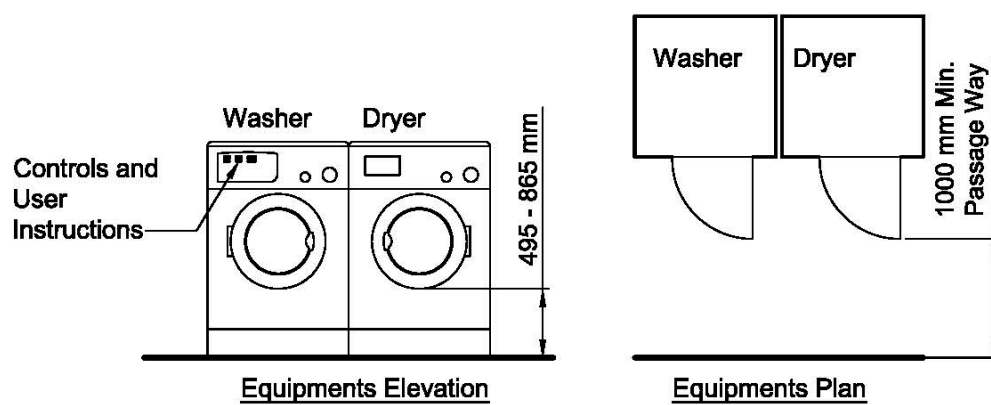

Figure 46: Washing and drying machines

# CHAPTER 6

## THE CITY



# 6 THE CITY

## 6.1 INTRODUCTION

The city and region hosting a major event such as the Paralympic Games has the opportunity to improve its infrastructure. This also enhances the quality of life for people with a disability. Cities should consider improving inclusion and accessibility in all areas of infrastructure and services provided for the Games. Such advancements will provide a lasting legacy that will benefit the city, its citizens and visitors for years to come. This section looks at the different transport methods, lodging and services that are provided during a major event.

## 6.2 TRANSPORTATION

Accessible transport is the single most important aspect for creating an inclusive urban environment. While every type of transport is examined individually in this section, all of these types together form an interconnected network which links the various accessible facilities and creates a 'seamless chain of accessible facilities' or a 'Universal Accessible Transport System', where accessibility is inbuilt in the system rather than accessible solutions provided as an 'add-on'. The transportation methods explored in this section include road, rail, air, and maritime.

The key objective of transport planning is to develop an Accessible Transport Strategy, which will address the needs of all stakeholder groups including spectators, Games Family, media and workforce in their travel from home all the way to venue and return.

### 6.2.1 ROAD TRANSPORTATION

In order to be accessible, a car/minivan or taxi needs to fulfil certain conditions to allow easy access and use by people with mobility impairment(s). It is important to understand that not all people in wheelchairs require a car with adaptations to be able to use it. Many users of manual wheelchair can transfer into any car. It is common during major events to find many wheelchair users using 'non-accessible cars'. Described below are some of the requirements related to cars and vans. Note the user is the ultimate one to determine what kind of vehicle would be more convenient.

#### Van

Vans are often the most comfortable vehicle for people with a high mobility impairment. In order to consider a van accessible, it must provide accessible loading and unloading systems that will allow a person to transfer as independently as possible. There are different loading systems that provide easy transfers into the van.



- Side (preferable) or rear access to allow a wheelchair user to remain in their mobility aid while being transported. A front passenger seat which swings out towards the user to ease entering the vehicle. This chair would have the ability to move up and down to meet the height of the wheelchair seat.
- In the case of a person staying in his/her own wheelchair, allow a minimum height clearance inside the vehicle of **1,370mm**. This allows a tall person sitting in his/her own wheelchair to be safe and comfortable in the vehicle.
- The vehicle should provide the opportunity to transfer into a regular seat. Many manual wheelchair users prefer to transfer into a regular seat, especially if traveling long distances. Manual wheelchairs can be very unstable while a car is moving, making it dangerous for the person.
- Have a balance between space available for wheelchair users and standard seating, so that escorts, colleagues and companions can sit together.
- Van ramps or lifts should come out at the sidewalk level to make it easier for the wheelchair users to enter or exit the van. Refer to Figure 47: Van ramp dimensions.

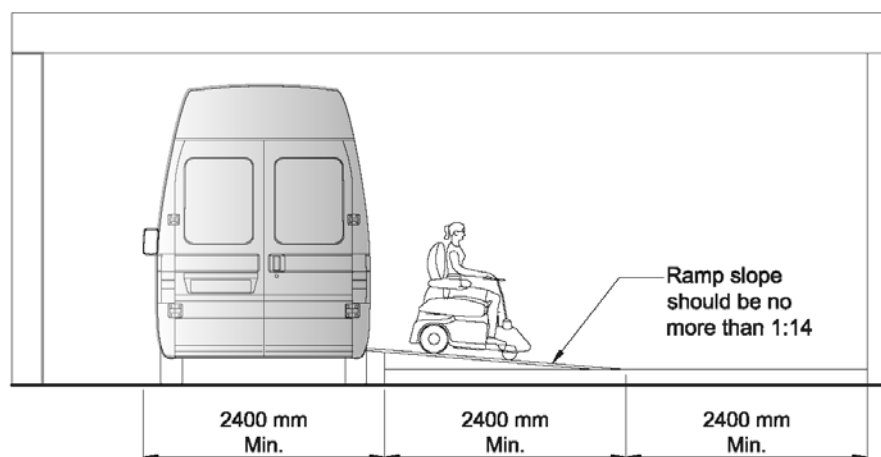

Figure 47: Van ramp dimensions

## Car

- Cars can be easy for some people to transfer. It is important to park the car away from the kerb to place the wheelchair at the street level and facilitate the transfer.
- The boot (trunk) must be free of objects to allow for storage of foldable wheelchairs. In some instances, wheelchairs are not foldable or able to be taken apart. Under such conditions a van is preferred.

## Types of loading mechanisms

- An external hydraulic hoist – this is the most used mechanism for smaller vehicles for wheelchair access. Often, it is installed at the back of the van or bus with a raise and lower height of approximately **1,000mm**.
- A rear-loading ramp – this allows direct access for a wheelchair user (sometimes two) into the rear of the vehicle. The rear ramp lowers between the wheel arches hydraulically. Unfortunately, due to the ramp gradient, the driver should often assist a person who uses a wheelchair into the vehicle. The vehicle should provide enough overhead space for the passenger, defined on the van description of Section 6.2.1 Road Transportation.
- A side-loading ramp – several taxis and small commercial vehicles now have a side loading mechanism. This type of vehicle has had its chassis lowered, allowing a ramp to automatically, or manually, link to the pathway.

Note: some wheelchair users prefer to transfer from their wheelchair into the passenger seat. If this is the case, a sedan is preferable to a larger vehicle that sits higher off the ground.

## Coaches

In order to be considered accessible, coaches need to have a loading ramp that allows entry of a person in the vehicle without having to move out of their wheelchair.

An internal hydraulic hoist is most often used for motor coaches. They are typically positioned in the mid-section of the bus and rise up to heights of at least **2,000mm**. Due to their size and shape, use of these hoists necessitates a loss of seating in the bus.

## Public buses

In order to be considered accessible, public buses need to fulfil the following conditions:

- Low floor chassis and lowering mechanism that allows them to link with a pedestrian kerb without steps being negotiated.
- Suspension lowers on one or all sides to allow the bus to lower to the same height as the kerb.
- Have at least one accessible door. However, two accessible doors are best practice, provided that the internal corridor linking the two doors has a minimum width clearance of **800mm**.
- Have a small ramp, that either automatically is placed on the kerb or is folded out from the bus, to provide the link. This type of mechanism allows direct access through the front door of the bus.

### Accessible vehicles technical specifications

The main technical specifications of any accessible vehicle are as follows:

- Door clearance height shall be at minimum **1,400mm**
- Internal clearance height shall be at minimum **1,500mm**
- Doorway width shall be at minimum **800mm**
- Loading platform shall be at minimum length of **1,300mm**
- Loading platform shall be at minimum width of **800mm**
- Weight operation shall be at minimum of **200kg**
- Lift loading time is recommended to be less than one minute
- Use of active and passive restraint systems is recommended

### Load zones and public bus stations

- All accessible public transport stops should provide lighting, shade/shelter, and rest seating with side arms and backrests.
- All set-down and pick up areas shall have a kerb height that appropriately interfaces with an Ultra-Low Floor Bus - typically **150mm** in height.
- The minimum width at a transport set-down or pick up is **1,800mm**. This will allow two wheelchairs to pass.
- All transport set-downs and pick-ups have kerb ramp access to the adjacent pathway from the roadway to allow direct access by people who use wheelchairs. The running slope of the kerb ramp should meet the specifications outlined in Section 4.5 Kerb ramps.
- Rubbish bins, seating, lighting, timetables, and other similar objects should be placed away from the pathway to not cause an obstruction to pedestrians.
- Place tactile hazard indicators as described in Section 4.9.6 Tactile cues.

## 6.2.2 RAIL TRANSPORTATION

Using rail transport as a standard route, such as metro lines, light rail, and trains, is critical for effective transport in a host city.

In order to provide high-level services to all potential passengers, railway authorities need to work with transport operators to create the widest possible number of journey opportunities for all sections of the community visiting the Games by enhancing and improving access to information, infrastructure, carriages, and staff training. Especially for the Games, transport planning and design should examine the question of the impact on access for all sections of the community.

## Accessible stations

Railway stations should include infrastructure and services that are accessible to the widest range of potential users. Main elements are:

- Path of travel should be fully accessible throughout the station. See Chapter 3 - 4 of this guide for further information related this topic.
- Access to platforms, road, and elevators or accessible routes should be free of steps and easy to find by anyone.
- Low counters with induction loop facility and alternative formats of printed information.
- Accessible toilets.
- Tactile surface on platform edges which will allow a person with a visual impairment to identify the edge of the platform. A tactile surface with a width of **500mm** should be placed on the edge of the platform.
- It is preferred to have a platform that is levelled with the train. Where this is not possible, a portable ramp should be provided to allow access onto trains. The station should have an operational system in place where staff are trained to operate and provide such service.
- If a train leaves a gap of **75mm** or greater, a temporary platform should be provided to safely load or unload passenger in wheelchairs.
- Where the difference between the train and the platform is more than one step, there should be a platform lift that raises to the floor level of the train (an additional ramp to bridge the gap between the train and the platform may be required). Also, when required a permanent or temporary ramp links directly to the floor level of the train.

## Accessible carriages

Train carriages should include features that make them accessible to the widest range of potential users. The main elements include:

- An entry door to the train at least 850mm wide to allow a wheelchair to enter the carriage.
- At least two wheelchair spaces per carriage or at least two wheelchair spaces per train (**1,300mm x 800mm**).
- An accessible pathway within the train that links to an area where a person who uses a wheelchair can remain in their wheelchair with adjacent space for a companion to sit in a passenger seat where the person can transfer. If the train ride is long, many wheelchair users prefer to transfer into the train seat.
- Wheelchair spaces that are located near, or have access to, food and beverage (if service is provided).
- Information in both audio and text format about next stations, journey information, etc.

- Interstate, country or out-of-metro-area trains need to ensure there is a gender-neutral accessible toilet available.
- Contrasting colours on all handrails.
- Automated doors.

### Light rail and tram

Provisions for light train, tram or metro stations and carriages are in general the same as for the trains. However, light train, tram and metro carriages should offer a level interface with all platforms and a maximum gap of **75mm**.

Exceptions to these are the toilets (typically not provided for passengers in such means), access to food and beverage, and adjacent companion seats.

### Other provisions

The availability of a sophisticated, web-based solution for transport information, online booking, and similar issues will help passengers of any ability, but is critical for a passenger who needs to ensure an accessible journey. This should include an accessible travel planner and simple maps showing accessible stations.

Adequate numbers of well-trained staff are fundamental to ensure the service levels provided by staff match the accessible infrastructure in place.

## 6.2.3 MARITIME TRANSPORTATION

In order to be considered accessible, ports and terminals, as well as vessels and ferries, need to provide a seamless series of amenities and services that enable every individual to embark, disembark, and use the services provided to the public.

The main elements of such series are:

### 6.2.3.1 PORT SERVICES

#### Terminal amenities

Terminal/port facilities including, but not limited to, washrooms, retail, service counters and kiosks, should meet the same requirements for similar facilities and services as described in Chapter 5 Washrooms and other plumbing elements.

#### Information/communications

Provide large print and audio versions of schedule and route information. Provide Teletypewriter (TTY) telephone service for the benefit people who are hard of hearing or deaf. Ensure websites are W3C compliant for accessibility.

## Parking

Provisions for accessible parking specified in Section 6.3 Parking of the Guide apply also for parking at ports and terminals.

## Ticket sales

Ticket booths need to provide universal access to all users (see service counters). Drive-through sales booths should not require a side reach in excess of **450mm** for service.

## Best practice infrastructure

Provide a wharf or pier that allows the vessel to directly link to it without the need to negotiate steps (an additional ramp to bridge the gap between the vessel and the wharf or pier may be required).

Have a permanent or temporary ramp that links directly to the floor (and additional ramp to bridge the gap between the wharf or pier and the vessel) of the vessel.

### **6.2.3.2 VESSEL SERVICES**

#### Access to vessel

Conventional ingress and egress of vessels can be problematic for many users. As the population continues to age and people with mobility impairments are increasingly common, this problem will become an even greater challenge that needs to be addressed.

Conditions that affect independent ingress/egress - particularly on smaller vessels where passengers enter and exit off car decks - need special attention. The crew and maritime company need to minimise tripping hazards, reduce gradient and cross-slope, and provide better marked pedestrian routes on and off vessels.

All crewmembers working in these areas of a vessel need to have disability awareness training, experience, and willingness to assist passengers who request assistance on and off the vessel.

#### Passenger Seating

Universal design principles need to apply to the fullest extent possible. All seating on board needs to accommodate a broad range of individuals. Vessels should not offer only high stools with no back, or bench seating with no armrests or kick space, or any other single type of seating. Instead, they should offer a variety of seating choices that accommodate to the needs of many different individuals.

Accessible seating needs to be integrated into different areas of the vessel. Grouping all the wheelchair users into one area is not appropriate. People with mobility

impairment should have a choice of seating in different areas, just like other passengers. Therefore, seating areas need to integrate open spaces that can be used by wheelchair and scooter users. Furthermore, 5% of the total designated accessible seating should accommodate guide and service dogs. Extra floor space of **500mm x 1,300mm** per seat should be allotted.

Where there are passenger lounges on a ferry, at least 5% of seating across all lounges should have a design and an adjacent clear floor space that permits easy transfer of a person to and from a wheelchair. The floor space should be large enough for a service animal to lie down. This seating should be designated by signage for use by persons with disabilities.

Seat height should be a maximum of **480mm** from floor, approximately **420mm** deep and **420mm** wide.

### **Alternate formats for printed material**

Operators need to offer alternate formats of materials generated for passenger use onboard the vessels, including:

- Large print, non-formatted text and electronic versions of all materials intended for public consumption
- Audio recording of material

### **Vessel amenities**

All onboard facilities, including common and gender-neutral washrooms, retail, service counters, kiosks, restaurants and lounges, should meet the same requirements for similar facilities and services found elsewhere in this document.

### **Safety provisions on board**

A specific passenger-briefing card intended to inform passengers with a disability about important safety features, procedures, and vessel accessories affecting them should be provided. The card should include provisions for persons with mobility, vision, and hearing impairments. It should also inform passengers that may receive a personal briefing from a crewmember covering procedures and vessel layout. Cards should carry the accepted international symbol of the impairment group, set in a broad field of colours.

Consistent colour coding of these user groups on all ticketing and dashboard displays could support operations, evacuation, and loading efforts later.

An additional passenger-briefing card addressing seniors is also advised.

## 6.3 PARKING

Accessible parking spaces are designed to allow wheelchair users or people with reduced mobility to transfer in and out of the car, either while they are the passenger or the driver. All parking lots, garages or street parking should provide an adequate number of parking spaces with the proper accessible features considered.

### 6.3.1 PARKING AREA REQUIREMENTS

It is important to consider some of the following design parameters when designing accessible parking areas:

- Designated parking spaces must be a minimum of **3,200mm** wide, while best practice is **3,600mm**. Two spaces can share the transfer zone to help minimize the space requirements for designated parking.
- Accessible parking spaces shall be level, have a maximum cross-slope of **2%** in any direction, have a firm, slip resistant surface, and be located as close as possible to an accessible entrance.
- One in eight designated spaces need to accommodate side lift vans. Van parking requires a total width of **4,600mm** (expanding the transfer area by **700mm** to accommodate the lift).
- In car parking areas, a minimum of **2%** (best practice is **3%**) of car spaces should be provided for people with disability. These spaces shall be located at the most convenient point for the users, taking into account proximity and with a safe route to:
  - Pedestrian entries and exits
  - Lifts and ramps
  - Accessible toilets
  - Pay stations
- Wheelchair users are at risk in parking lots because they travel in the seated position, making them more difficult to see when wheeling behind vehicles. Also, people with reduced agility are unable to react as quickly to danger and get out of the way of traffic. Therefore, exit routes should be located in front of the parked cars.
- Where designated parking is not directly connected to the sidewalk, it is important to minimise the need for people with mobility impairment to travel behind parked cars. Where travel behind cars is unavoidable, a marked pedestrian route should be provided to the closest exit or accessible sidewalk.
- Underground parking stations should provide a minimum of **2,300mm** head clearance (best practice is **2,500mm**) throughout, to ensure wheelchair roof mounted vehicles can operate.
- Exit doors serving designated parking areas should be accessible to people with a mobility impairment. This requires 'U' shaped levered handsets or 'panic bar'



hardware. Automatic door closers should be low resistance, delayed action closers.

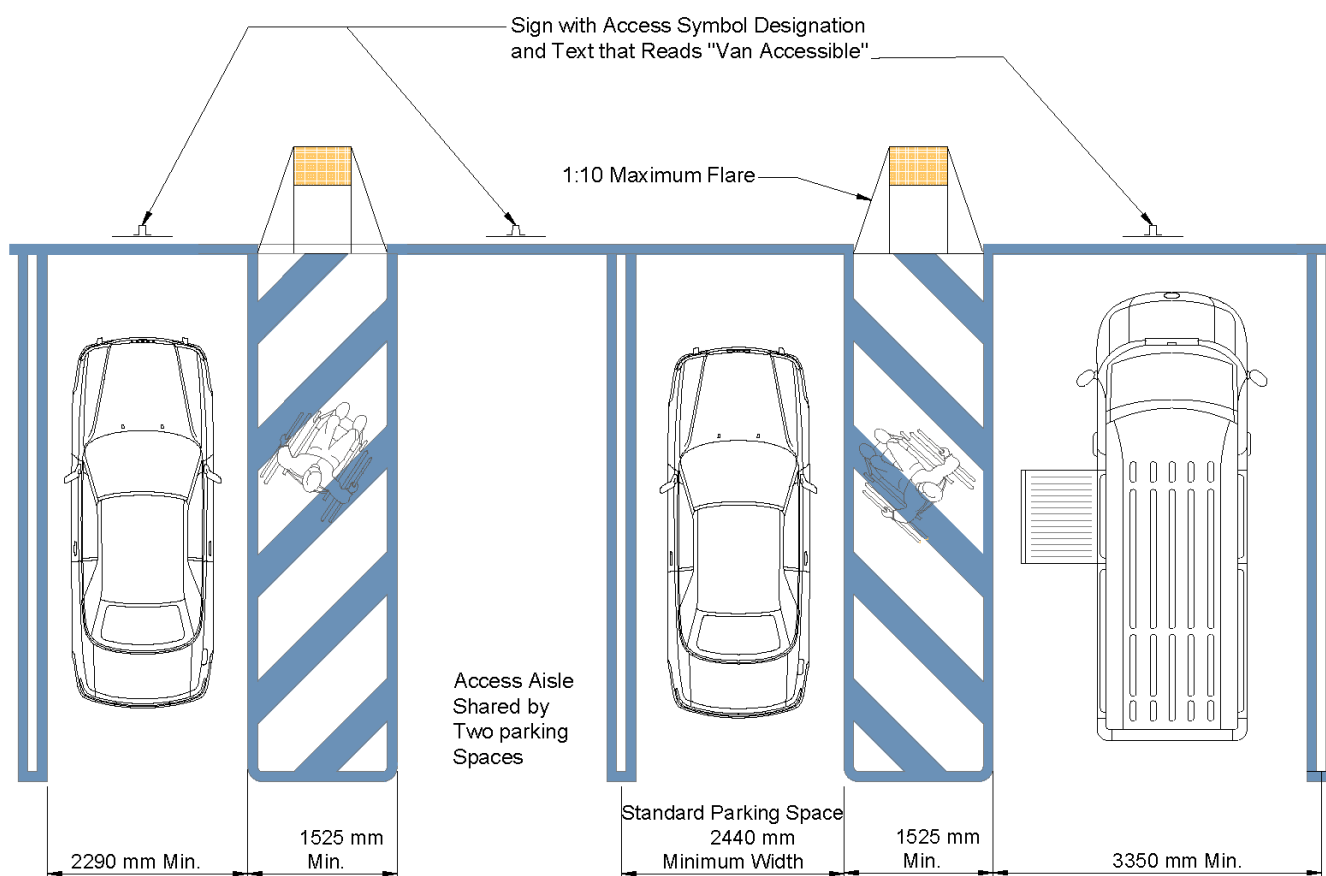

Figure 48: Parking spaces and access aisle

### 6.3.2 SIGNAGE FOR ACCESSIBLE PARKING

Clear arrival, exit and directional signage legible in all light conditions should be provided. The signage shall start outside the car park so that constituents are advised in good time which lane they should be in for accessible parking. Signage shall be provided at every internal change in direction. All ground surfaces, including painted signs, shall be slip resistant.

- An international symbol of access shall be provided on both the ground (best practice is for the size to be **1,000mm x 1,000mm**) and vertically in front of each car space. The vertical sign should be **300m x 250mm** and placed no lower than **1,500mm** so that it can be seen over a car.
- Access provisions for the car park exit shall be similar to, and consistent with, those for the car park entry.

### 6.3.3 VALET PARKING

The valet parking in any facility should provide an area that is easy for a person with a disability to leave the car safely. Staff should be trained to know how to approach a person with a disability, regardless of whether they are the driver or the passenger. Cars that are adapted for people with mobility impairment can be driven by anyone, although sometimes certain accommodations cannot be altered. The valet attendant must ask about any special accommodations before driving the vehicle. If a person with a disability arrives with a driver, although the driver will take care of the wheelchair, a safe space for the transfer to open a lift must be provided. If there is a step, a permanent kerb cut must be provided. For further details refer to Figure 49: Passenger loading zone with alternate kerb cut locations.

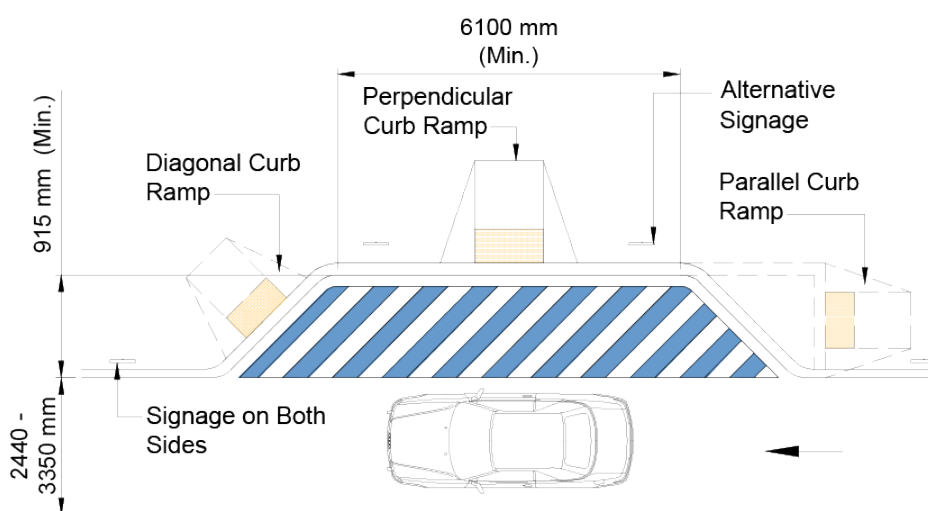

Figure 49: Passenger loading zone with alternate kerb cut locations

## 6.4 AIRPORTS

In most jurisdictions passengers with disabilities and passengers with reduced mobility (PRM) have legal rights to assistance when travelling by air.

Usually individual airlines decide if there is an upper limit on the number of PRM passengers they can accommodate on a single flight based on safety considerations.

The following services should be available at all airports for passengers with a sensory, physical or learning impairment which affects their mobility.

During Games-time, there will be a large number of people with a disability travelling at the same time, often together. The usual standard services available at an airport will not be able to cope with the expected demand. Therefore, it is imperative that

practical and far-reaching increases in trained personnel available to provide assistance for passengers with disabilities during Games Time are put in place to meet the expected need.

### **6.4.1 PRE-FLIGHT INFORMATION**

Ensure all passengers with disabilities, including athletes and Games Family, are made aware of all rules and regulations relating to carriage of wheelchairs (especially battery-operated) and other mobility equipment.

Develop a stringent information gathering mechanism to assess the detailed requirements of each passenger with a disability from a Paralympic team and members of the Games Family travelling to the host country, including to and from training camps and accommodations.

Ensure that travelling Paralympic teams are given an information sheet detailing all the accessible services and facilities available, especially toilets for people with different disabilities, throughout the terminal.

Wayfinding is critical in the airport terminals. See Section 4.9 Signage wayfinding and public spaces for further recommendations.

### **6.4.2 CHECK-IN AND MOBILITY EQUIPMENT CARRIAGE**

An airport should provide help with registration at check-in, in particular to people with a visual impairment.

Automatic check-in points should provide machines at the appropriate height to be used by people of lower stature or wheelchair users. Also, the personnel supporting in this area should be trained to help people with disabilities.

At check-in, a decision should be made in conjunction with the passenger regarding carriage of any wheelchairs or equipment.

When any battery-operated mobility equipment is checked in for carriage by an airline it must be properly tagged with as much information as possible:

- Dry or wet cell battery
- How to disconnect the battery
- The weight of the chair
- How to put the chair on manual
- Contact details of the owner

Whenever possible, the passenger with a disability should be allowed to keep any wheelchair or mobility equipment with them until reaching the aircraft. This is considered best practise unless the passenger prefers otherwise.

Airport management should inform the passenger about the maximum weight allowance for all wheelchairs and equipment that can be used up to the aircraft door.

Only if the wheelchair exceeds this maximum weight should it be checked in with heavy articles for the hold.

All wheelchairs and mobility equipment should be considered specifically sized and outfitted for the individual equipment owner and, therefore, it should be assumed that it is extremely difficult and sometimes painful or dangerous for passengers with a disability to be in a standard airport wheelchair for an extended period of time.

### **6.4.3 MOVING THROUGH THE AIRPORT**

Some passengers will not have their own mobility aid or wheelchair, but will require assistance with moving through the airport to security and on to their boarding gate.

This assistance should be provided using an airport wheelchair or an electric multi-person vehicle. Ask the passenger needing assistance which they prefer.

At security, passport control, and immigration provide fast/priority lanes for people with a disability and PRM passengers so that mobility assistance staff can be used efficiently.

Training to security staff to ensure wheelchair users do not use pass through metal detectors, but go around, should be provided.

Security staff should also be trained to ensure PRM passengers are given a 'pat down' check and/or checked with a wand.

Security staff must:

- Always ask for permission before touching the passenger
- Always ask if there are any sore/delicate areas of their body

Passengers taking their own battery-powered wheelchair to the boarding gate should have their wheelchair and hands tested for explosives using a swab machine.

### **6.4.4 BOARDING THE AIRCRAFT**

If the aircraft is served via a staircase only, then an ambi-lift should be used to help board people with a disability and PRM passengers.

Should the aircraft be served by an air bridge then a person with a disability or PRM passenger may board unaided.

For passengers who need assistance to their seat, an aisle chair should be deployed by airport staff.

Once on board the passenger with a disability should be given:

- A briefing on emergency procedures and the layout of the cabin
- Help with stowing and retrieving baggage on the plane
- Assistance to the toilet using an on-board aisle wheelchair

### **6.4.5 DISEMBARKATION OF THE AIRCRAFT AND ARRIVALS**

The disembarkation of passengers with a disability should meet the needs of each individual or sport team expressed in the pre-travel information gathering exercise.

Ensure those passengers requiring a full lift from their airline seat into the aisle chair are always served by two fully-trained members of the mobility service team. If the flight has more than four passengers that require an isle chair to deplane, the airport should provide two isle chairs to expedite the process.

The customs area should provide a lane that meets the minimum requirements of a passageway described in Chapter 4 All accessible routes of this guide. Also, the service desk or window should have the appropriate height described in Section 3.5.2 Table and counters to appropriately serve people of lower stature and those in a wheelchair. Develop a protocol and put in place training so that immigration staff can efficiently and sensitively interact and process passengers with disabilities who cannot provide fingerprint information, are hard of hearing or, if in a wheelchair, they speak to them - not the assigned assistant.

## **6.5 PUBLIC SERVICES**

Public services and facilities include live sites, tourist attractions, public spaces, shopping areas, and mobility centres. These services and other resources provided to the broader community should be available to all citizens and visitors, and meet the needs of the widest possible array of potential users regardless of age, size, educational levels and functional abilities.

For a city to be ready to host the Games, access to public services, historically significant buildings and other sites of significance should be available to all. It is not enough that a given venue used in the Games is accessible to persons with disabilities. The Games' Experience relies on a positive connection to the host city both as a facilitator of all things and as a destination in its own right.

### **6.5.1 CITY PARKS AND OUTDOOR RECREATIONAL AREAS**

Outdoor recreational areas are a key component of what a city has to offer to its visitors and residents. The city should ensure parks and outdoor areas respond to the needs of extended families and those where one or more family members are a person with a disability. Frequently it is difficult for such families to find accessible, family recreation. Inclusion of people with a disability in outdoor spaces, activities, and events is an integral part of design. Access to outdoor areas needs to come from accessible pathways, appropriate kerb ramps at each intersection, and an expectation by planners that parks and outdoor facilities will be used by the whole community. This includes accessible play equipment, drinking fountains, barbecue areas, seating, and tables.

Parks and outdoor recreational areas need to provide accessible routes and spaces. Physical access to parks includes consideration for people with a mobility impairment as well as people with a vision or cognitive impairment. Intuitive wayfinding techniques will assist people with a cognitive or other intellectual impairment, as well as assist all other users.

**Best practice for accessible park or outdoor recreation facilities:**

- All trails and paths should provide an accessible path that allows any person to enjoy all the amenities provided. All pathways, sidewalks, and connecting routes follow Chapter 4 All accessible routes guidelines.
- Where bike paths are provided, they should protect riders from passing vehicles. Trail turnaround points should be available for cyclists to safely return and should include enough space for a handcycle to turn.
- The material used to pave the trails should be firm to enable access for people with any disability.
- Playground equipment/areas should accommodate both children with a disability and a supervising adult with a disability.
- Concession stands and other service counters should meet universal design principles for counters.
- Swimming and wading pools should safely accommodate people with a disability with transfer spaces, change facilities, wayfinding, and emergency evacuation procedures.
- Bleachers or other viewing/seating areas should provide basic physical access for people with a disability or reduced mobility, and should take into consideration people of lower stature - which will also benefit children and people in wheelchairs. In conditions where there is a site view, such view can be explained with audio service and braille for people who are vision impaired.
- Washroom facilities include at least one gender-neutral accessible washroom, which should meet specifications in Chapter 5 Washrooms and other plumbing elements.

### **6.5.2 RETAIL AND FOOD AND BEVERAGE OUTLETS**

Retail and food and beverage outlets outside of venues are an integral part of the visitor's host city experience. Welcoming environments are created with clear menu displays (including a number of hand-held versions), counters that are accessible to wheelchair users, aisles that are wide enough for people with a mobility impairment, and disability awareness training for front-line staff.

Access for people with a mobility impairment should be provided in all outlets, from kiosks to large storefront locations.

**Best practice for accessible retail and food and beverage outlets:**

- Minimum aisle and line-up widths for wheelchair users needs to meet the minimum requirements described in Section 4.2 Pathways.
- Aisles need be kept clear of displays and clutter, with turnarounds provided at the end of each aisle.
- An integrated counter design, that incorporates universal design principles at the point of sale, needs to be part of the main service area to accommodate all users. See Section 3.5.2 Table and counters for specific information.
- Knee space under cash/service counters needs to enable wheelchair users to face the clerk and complete transactions.
- Stock shelves vertically to ensure that some of each product is available to all levels of range of motion.
- Any cooler and/or shelf doors slide rather than swing open.
- Bulk condiment dispensers are preferred, as individually packaged condiments may be difficult to use for some persons with a disability.
- Any waste bins have a maximum height of **1,200mm** and require minimal hand dexterity to operate.
- Fixed seating, such as booths, are generally difficult for people with a mobility impairment and older adults, as well as being inaccessible for wheelchair users. If booths are used, make available alternative seating at accessible, conventional tables.
- Where bar seating is provided, each bar needs to have a lowered section suitable for at least two wheelchair users and/or people unable to use high stools. The length of the counter should be a minimum of **1,600mm** and meet other specifications in Section 3.5.2 Table and counters.
- A mixture of chairs with arms and chairs without arms should be available in each setting, with a minimum of one chair with arms per five chairs without arms.
- All staff should complete training to serve clients with different kinds of disabilities.

## **6.6 HOTEL**

In today's marketplace hotels across the globe compete on quality, price, and the provision of services and attractions. However, a large segment of the population is currently excluded by the majority of tourist accommodation facilities due to variations in accessible service levels and a lack of available information to accessibility features at a specific hotel.

Accessibility in hotels not only responds to the needs of an expanding market segment, as the average age of the population increases, but also other potential clients; for example, parents with pushchairs, people with injuries, and tourists with heavy luggage. It is necessary to rethink the design and types of hotel amenities and guest rooms in terms of access. A universal approach with accessible solutions is the recommended best practise, which will suit more guests and increase the rentability

of the hotel. To accomplish this design approach, all guest rooms should be fully accessible and mobility friendly, and all hotel amenities must be accessible. The following sections provide greater details.

### **6.6.1 ACCESSIBLE AMENITIES**

#### **Parking**

Accessible car parking should be provided and meet the minimum requirements found in Section 6.3 Parking. The distance between the parking and accommodation site entrance should be at maximum **100m**.

#### **Drop off and pick up zones**

Often hotels provide a valet service for the guests. This area should follow the recommendations described in Section 6.3.3 Valet parking.

#### **Services within accommodation sites**

While essential, access to a bed and a bathroom is not the only service hotels offer to their guests. Providing functional and dignified access to all other services available to other guests is a condition for an inclusive hotel.

#### **Reception**

An accessible pathway should exist between parking, entry and the reception area. For specific details regarding pathways refer to Chapter 4 All accessible routes.

If the facility has more than one entrance, information should be given on the most accessible entrance, which should be easy to find. Pathways should be wide enough to let people pass easily and should be kept free of obstacles.

The reception counter should be accessible or have an accessible segment according to Section 3.5 Reach range, knee and toe clearance.

Main information about the hotel should be readily available in alternative formats for guests with sensory limitations.

#### **Restaurants, cafés and bars**

In restaurants, cafés and bars, the aisles should be wide enough to allow visitors to move around easily when the tables and chairs are in use, according to Section 4.2 Pathways. Also, the furniture provided should be accessible to allow easy seating and access to the different products or services. For specific information about best practices for food and beverage outlets, see Section 6.5.2 Retail and food and beverage outlets.



Service dogs should be allowed into eating facilities. Menus should be available in alternative formats, such as Braille and large print.

## **Shops**

The ability of visitors with a mobility impairment (such as limited reach) to access goods on shelves and display racks should be considered. A good practice is to distribute goods vertically instead of horizontally. See Section 3.5 Reach range, knee and toe clearance.

Space between the aisles should abide with the provisions about circulation areas and be no less than **1,000mm**.

## **Support services and equipment**

Several support services and/or equipment can be used to further enhance the experience of all guests of an accommodation site, including:

- Braille and large print restaurant menus
- Audio tape and Braille versions of hotel services information
- Raised toilet seats upon request
- Shower bench seats
- Portable personal lift to help guests transfer to bed
- TTY (TDD) machines for the telephones of guests who are deaf
- Telephones with volume controls and/or oversized buttons
- Vibrating or talking devices such as alarm clocks, door signallers, and telephone signallers

## **Emergency planning**

Having specific equipment and evacuation plans is an important part of serving guests with disabilities. Appropriate disability awareness training for staff will help facilitate safe exiting of people with a disability.

Refer to Section 3.7 Emergency provisions for further detail on:

- Areas of rescue assistance
- Alarms
- Building evacuation instructions

## **Temporary solutions**

Several temporary solutions may be used to provide a better service to guests of any level of mobility, sensory or mental capacity, including:

- Installation of a low hanger rod
- Reversing swing of bathroom door to increase useable space inside
- Removing bathroom door (with guest permission)
- Replacing pedestal with legs or feet to accommodate bed lifts (risers)
- Providing cordless telephone in rooms where telephones are not beside the bed
- Providing valet parking service for over-height vehicles

## **6.6.2 ACCESSIBLE ROOM**

### **Description and considerations**

The height of thresholds, door widths, and clear circulation spaces are essential for wheelchair users. Equipment, such as cupboards and switches, should be within reach from a wheelchair.

The requirements of customers with hearing impairments should be discussed with them on their arrival and they should be informed of any procedures that may impact on their privacy/safety, such as housekeeping, room service and fire drills. A TV with teletext will benefit people with a hearing impairment by providing subtitles, and an induction loop connected to the TV output will help hearing-aid users.

If a person with a vision impairment is occupying a room alone, staff should offer to orient the guest on the position of furniture and facilities in the accommodation.

### **Entry door**

The door shall provide a minimum clear width of **850mm**, while best practice is **950mm** and should be equipped with 'U' shaped levered handsets.

Automatic door closers should be adjusted to provide a maximum of **20N** force. Where possible, conventional closers should be replaced with delayed action, low resistance closers.

Safety chains, locks and other hardware must be operable by one hand, not require good dexterity to operate, and be mounted a maximum of **1,200mm** above the finished floor.

There should be security viewers in the door, mounted at **1,000mm-1,200mm** above the finished floor. The outside area must have at least **10lux** of flat, even light for the benefit of people who have a visual impairment and people who are hard of hearing or deaf (to facilitate visual languages and/or lip reading).

The door should have low mounted, large format/high contrast evacuation information/route signage.

## Circulation and transfer space

The room needs to provide at least one space for circulation and change of direction. This space must be at minimum **1,200 mm x 1,200mm** (or diameter **1,200mm**) with best practice being **1,500mm x 1,500mm** (or diameter **1,500mm**).

Transfer space must be provided in all areas where the guest who uses a wheelchair is expected to move, such as toilets, beds, and desk seating. It is considered best practice to provide **915mm** or wider circulation space.

Existing paths and passageways should be at least **1,000mm** wide, with best practice being **1,500mm**.

**EXCEPTION:** While working with existing structures or reduced spaces, it is acceptable to use a minimum of **800mm** circulation space.

## Switches and controls

Controls and switches, including those for heating/air conditioning, should be within the range of **850mm-1,200mm** from the floor. Electrical outlets and data connections are located at **450mm** above the finished floor.

Lamp switches need to be easy to locate and operable by people with minimum dexterity. Wall switches for general light, and touch switches on bedside lamps, are recommended.

## Beds

Bed top height shall be **450-500mm**.

An aisle of at least **800mm** (with best practice being **915mm**) along at least one side of the bed is required.

The bed frame needs to permit a minimum **100mm x 100mm** kick-space between the floor and the bottom edge of the bed.

Beds on fixed pedestals prevent users from using common lift equipment and, therefore, are not recommended in accessible rooms.

## Closets

A manoeuvring space of **1,500mm** should be provided in front of closets.

Closets shall have a low mounted hanger rod at **1,200mm** above the finished floor. Split closets, with both high and low mounted hanger rods, are recommended.

Closets should be equipped with hangers that can be easily removed and re-hung. Closet interiors need to be well lit.

Hangers attached to fixed rings are very difficult to use for many people with mobility impairment. They are not appropriate in an accessible room.

Preferably, doors should be equipped with 'U' shaped levered or another accessible handle.

### **Furniture and finishes**

Furniture needs to be easy to access and operate. Hardware should be capable of being 'hooked' with a finger rather than grasped to operate.

If the access aisle to the bed is less than **1,200mm**, then the bedside tables need to provide a minimum toe space of **225mm high x 300mm deep**. Other tables should provide a minimum knee clearance of **700mm** underneath to a depth of **450mm**.

Carpeting needs to be low-pile, high density closed loop glued directly to the floor.

Thresholds should be totally avoided or flush. If unavoidable, they should not be higher than **25mm**.

### **Window and patio doors**

- Patio doors (if existing) need to meet requirements for doorways (above) for clear width, threshold, and hardware.
- Furniture arrangement should allow wheelchair users access to window/curtains, the operators of which must extend to at least **1,200mm** above finished floor.

### **Other equipment**

At least one telephone should be located within easy reach of the bed. Telephones should be compatible with hearing aids (contain a flux coil) and have a message-flash light. A telephone in the bathroom with a 600mm cord is recommended as a safety measure.

Televisions need to be equipped with remote controls and with closed caption decoders.

Clock radios should have large, high contrast displays.

### **Bathroom elements**

Overall, the provisions about washrooms described in Chapter 5 Washrooms and other plumbing elements apply for individual bathrooms at hotel accommodations.

Sinks should be equipped with levered or automatic taps and scald guard technology, as well as with offset traps or insulated drains.

A minimum knee clearance under the counter is **750mm** to a depth of **500mm**. The top height of the counter should be no more than **850mm**. The counter should provide the possibility of front or side approach.

Mirrors are to be mounted with the bottom edge at a maximum of **1,000mm**.

A telephone or other communication device or alarm needs to be located within easy reach of the toilet in case assistance is required after a fall or other emergency. Where handsets are used, a **1,500mm** cord is required.

### **Showers/tubs elements**

While a shower is considered a more accessible solution, people of different mobility or sensory capacity prefer bathtubs as well. An equal number of rooms with roll-in showers and accessible bathtubs are recommended. However, rooms considered fully accessible must be equipped with a shower.

All tubs and showers need to be equipped with an offset, single lever-mixing valve, and a hand-held shower held on a minimum **1,500mm** hose.

Accessible showers should be equipped with curtains, rather than doors. For specific information about showers and tubs, see Section 5.4 Shower and tub.

Overall lighting should be maintained at a minimum of **30lux**. Lighting at the counter/sink should be a minimum of **70lux**.

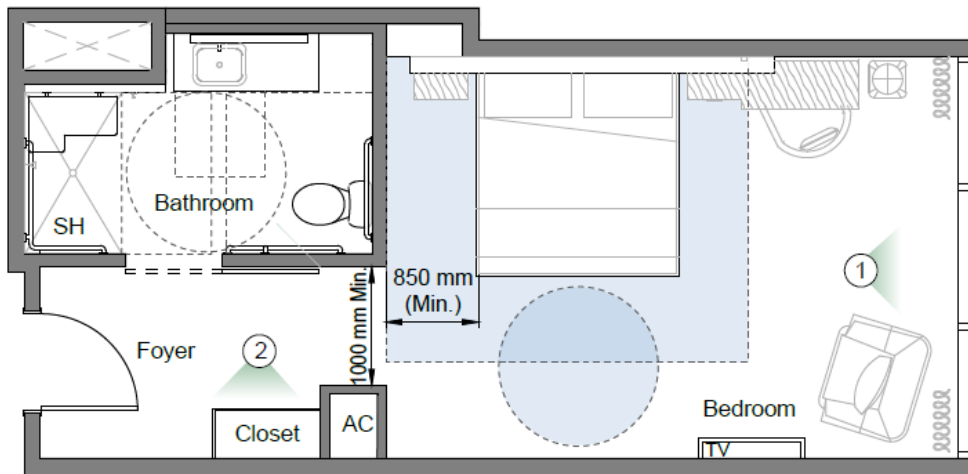

**General Notes:**

1. All bathroom elements shown in this image should follow the minimum requirements described on Chapter 3 and 4.
2. Tubs can be used on certain instances refer to Image 55 and 56 for further information and also to the plumbing elements sections in Chapter 5.
3. All grab bars should be connected to a reinforced wall.

**Figure 50: Accessible King Room floor plan**

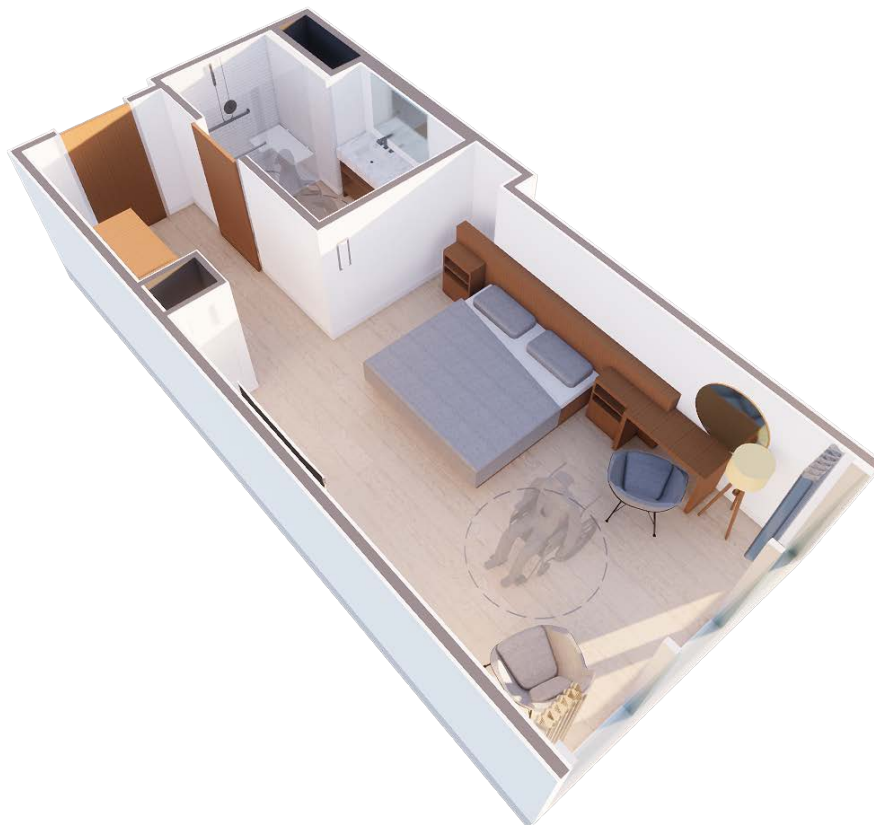

**Figure 51: Accessible King Room 3D layout**

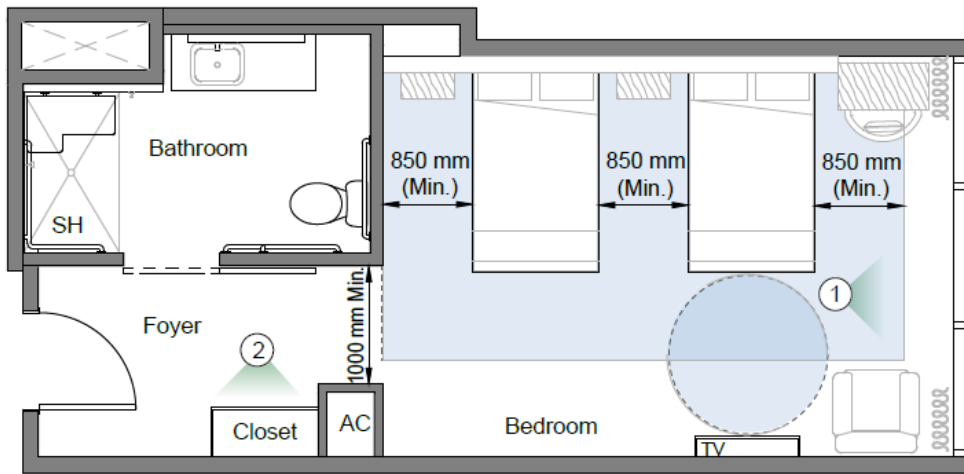

**General Notes:**

1. All bathroom elements shown in this image should follow the minimum requirements described on Chapter 3 and 4.
2. Tubs can be used on certain instances refer to Images 55 and 56 for further information and also to the plumbing elements sections in Chapter 5.
3. All grab bars should be connected to a reinforced wall.

**Typical Queen Accessible Room - Floor Plan**

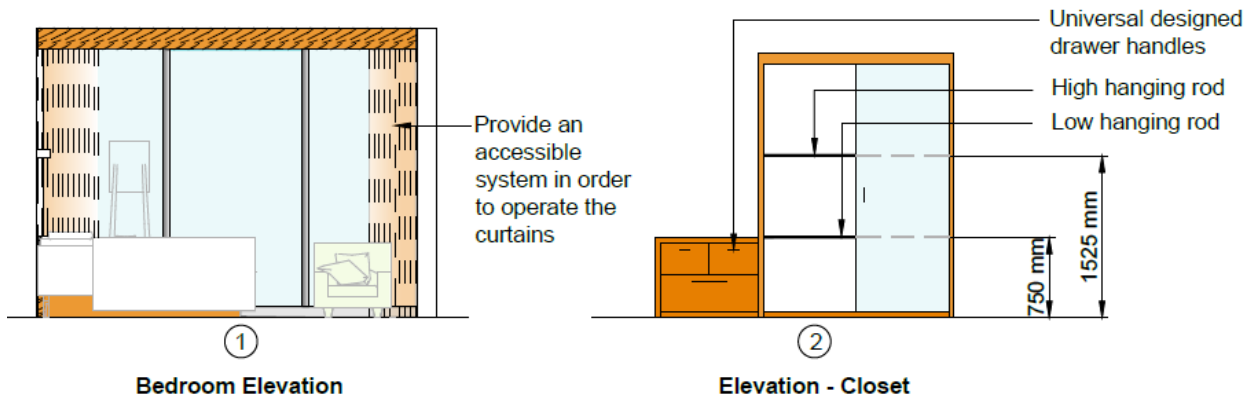

**Figure 52: Accessible Queen Room floor plan**



Figure 53: Accessible Queen Room 3D layout



Figure 54: Accessible hotel bathroom 3D layout



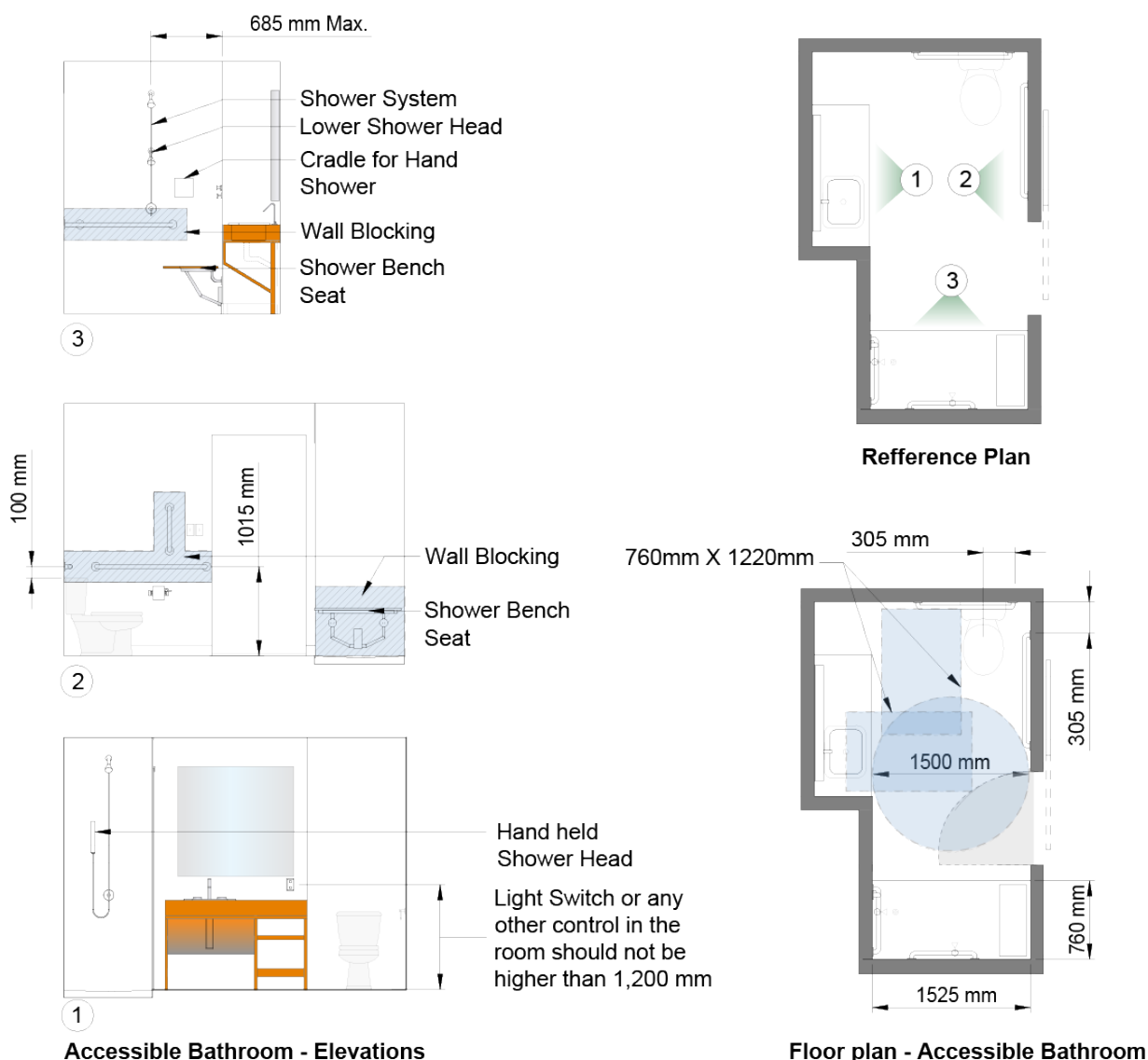

Figure 55: Accessible hotel bathroom features

### 6.6.3 'WHEELCHAIR FRIENDLY' GUEST ROOM

In the previous sections, the conditions for creating accessible guest rooms and bathrooms were specified. However, limitations, especially in older establishments, may cause several of those provisions not to be technically feasible.

On the other hand, some easy modifications can often make a guest room usable by a person with certain mobility or sensory limitations, even if not being accessible according to the standards.

In order to provide guidance to hotel owners and other accommodation providers who may not be able to modify existing rooms into fully accessible rooms, the IPC has introduced the notion of a 'wheelchair friendly' room. This approach may allow

providers to serve more customers with disabilities and allocate limited, fully accessible rooms in the most appropriate way, especially when accommodating groups.

For hotel rooms to be considered 'wheelchair friendly', the following requirements must be met:

- All door widths minimum **800mm**.
- At least one spot within the room with a diameter of **1,200mm x 1,200mm** (to allow for a change of direction).
- Transfer space of min. **800mm** on at least one side of the bed.
- Toilet seat of **450mm** height with adequate transfer space on one side. A handrail should exist or other suitable solid item for a person to lean on. It should not obstruct a transfer space area.
- Height of controls lower than **1,400mm** or provision of a suitable 'handling stick' for those above this height.
- Provision of a long stick with suitable edge to allow mounting and demounting of hangers in closets (hangers attached to fixed rings are not appropriate in a 'wheelchair friendly' room).
- Portable bath amenities (shampoo, shower gel, etc.) rather than wall-attached dispensers.
- Shower chair with back. If a shower is not available and a bathtub exists, handrails should be provided in the bathtub to allow entry and exit, as well as a bath chair. See Section 5.4 Shower and tub for further information.

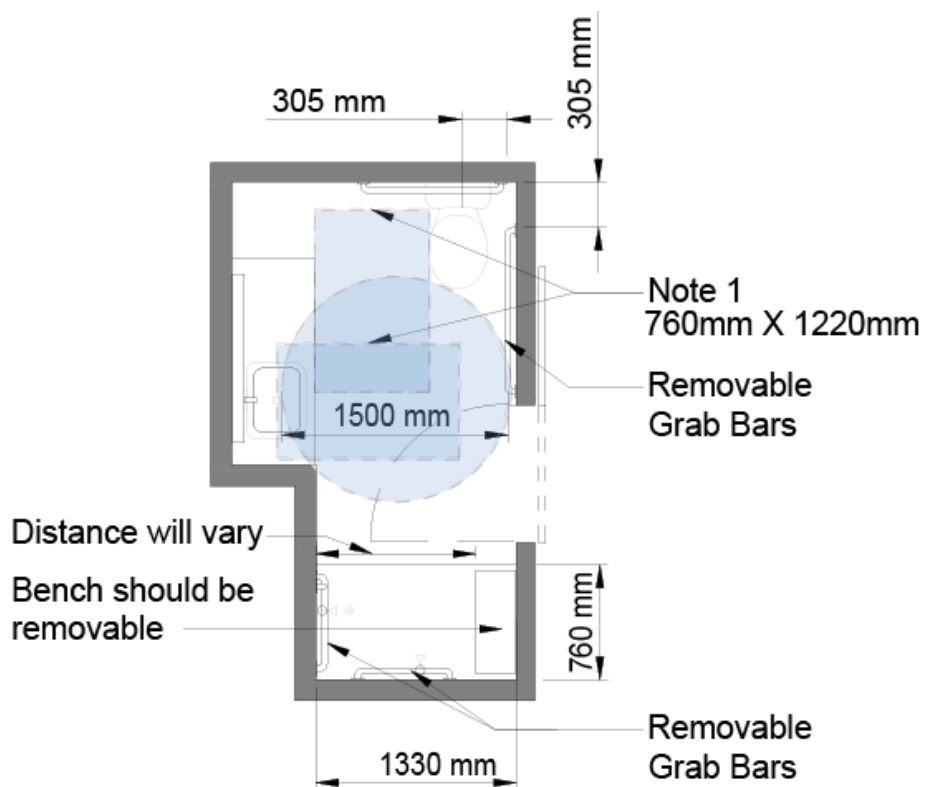
**Note:**

1. Circulation space can overlap under the sink space if pipe is not obstructing.

Figure 56: 'Wheelchair friendly' bathroom

# **CHAPTER 7**

## **OLYMPIC AND PARALYMPIC GAMES SPECIFIC GUIDELINES**



# **7 OLYMPIC AND PARALYMPIC GAMES SPECIFIC GUIDELINES**

## **7.1 INTRODUCTION**

The Paralympic Games, or any other major Para sport event, is a great opportunity for cities to improve their accessibility and become more inclusive. Inclusion brings a positive social, political and economic impact to the host city that goes beyond the infrastructure improvements.

The Paralympic Games have the ability to set a benchmark for accessibility in the host city that often becomes the example followed by other cities within the host country.

This chapter provides a thorough introduction to the accessibility guidelines for the Olympic and Paralympic Games and analyses the different concepts that affect the infrastructure and services needed for a successful Games.

### **7.1.1 WORKING FOR ACCESSIBILITY**

The IPC expects bid cities to commit to creating an accessible and inclusive Games environment for all, based on the provisions of this Guide.

For an OCOG working towards achieving optimum accessibility for the organisation and hosting of the Games, it is not simply a matter of following guidelines or precedents from previous Games; rather, it is a long learning curve, with knowledge and awareness gained through time and transferred to everyone involved in helping to deliver the Games. A core element is a focused and targeted approach to hiring and on-boarding people with a disability. Further details are in Section 7.5.18 People Management.

In a similar way, accessibility is not about ticking boxes in checklists, but rather a continuous process that takes place within the OCOG and with related city and public authorities and other agencies. This often requires extensive consultation and multiple reviews.

### **7.1.2 INCLUSIVE SPACES**

When designing a facility or a service, it is important to have in mind the different user groups to be served during the Olympic and Paralympic Games and the diversity within each of these groups. This diversity can include people who have impairments such as visual, mobility, cognitive, hearing or any other. The services provided and the facilities used should enable all users to be independent and able to participate at the Games in a barrier-free environment.

Designers can achieve accessible and inclusive spaces when they consider accessibility as a core principle and have it in mind from the early stages of the design process of a project; thus, it is crucial that the organisation endorses accessibility at the start of the planning process as well as during Games-time.

### **7.1.3 TEMPORARY STRUCTURE VS PERMANENT STRUCTURE**

If any new structures are built for the purpose of hosting the Paralympic Games, the aim is to leave a permanent legacy structure that is accessible and promotes an inclusive environment for all.

As part of Agenda 2020, there is greater emphasis on maximising the use of existing facilities and temporary and demountable venues where no long-term legacy needs exist. In all design aspects, accessibility should not be compromised in any temporary structures. Suitable solutions, via overlay or modified operations, are applied to maintain all users' ability to function with dignity and efficiency.

## **7.2 CREATING AN ACCESSIBLE AND INCLUSIVE OLYMPIC AND PARALYMPIC GAMES**

Often during the planning and delivery phase of the Games, applying the local or national building code requirements is used to define accessibility standards. Planners should recognise that local building codes only provide for the minimum requirements on accessibility. The underlying assumption is that the minimum is sufficient, when in reality it is only a starting point towards developing functional, dignified and equitable accessibility. Planning for minimum access does not address many of the barriers facing people with a disability and other persons who need an accessible environment, especially within the Paralympic Games context. In fact, providing for a real inclusive community means going beyond the minimum requirements. The people and Delivery Partners who construct or renovate facilities need to see beyond the minimum standards to encompass the needs of a widely diverse and ever-ageing community.

The requirements related to OCOGs and their delivery partners ensuring accessibility for all stakeholders with impairment are specified in the HCC - Operational Requirements.

An effective methodology to accessibility and inclusion involves a strategic and operational approach, a technical approach and an organisational approach.

## **7.2.1 STRATEGIC AND OPERATIONAL APPROACH**

It is essential to establish guiding principles and develop an appropriate operational model to deliver a truly accessible and inclusive Games. This will also enable a seamless transition between the Olympic and Paralympic Games.

## **7.2.2 TECHNICAL APPROACH**

Based on the provisions of this Guide, the OCOG and its partners are expected to apply the accessibility guidelines proposed in this document in a manner appropriate to the host country and its demographics and culture, while also considering financial and resource capacity.

A gap analysis between national standards and the standards outlined in this Guide takes place soon after the formation of the OCOG in the host city.

As a best practice, in cases where the national standards of the host country exceed requirements outlined in this Guide, the national standards apply and where the requirements outlined in IPC Guide exceed national standards, the IPC standards are utilised.

The requirement related to OCOGs developing targeted standards, using the IPC Accessibility Guide as a reference, are specified in the HCC - Operational Requirements.

## **7.2.3 ORGANISATIONAL APPROACH**

Achieving high standards of access and delivering a truly inclusive event can only be realised if the technical process for delivering access and inclusion is initiated during the early planning stages of the Games.

Therefore, it is vital to establish structures within the OCOG with the responsibility to ensure that accessibility and inclusion are provided at all Games venues (competition and non-competition) and throughout Games operations.

The OCOG and its delivery partners implement the design standards and adopt inclusive practices in all elements of the built environment and Games-time operations. The establishment of clear standards will ensure high quality and accessible services for the Games.

Where the specific conditions described in the Guide cannot be met for technical reasons, the principles of the Guide should be met by other means.

## **7.2.4 COMMITMENT TO A CONSISTENT CONSULTATION PROCESS**

Achieving high standards of access and delivering a truly inclusive event can only be realised if appropriate consultation is conducted to influence and advise Games planning.

The following actions start from the Candidature process and continue through all planning phases:

- Consult with groups for persons with a disability in the local community to seriously address their needs and allow their ideas to influence Games planning.
- The OCOG and/or the responsible city/public authorities include accessibility provisions in all tenders, including venue construction and renovation agencies.
- Commission expert advice from experienced accessibility and inclusion consultants.
- An ongoing equality and inclusion auditing process is in place to check all Games infrastructure, planning and services. Any amendments to a venue design are signed-off from an accessibility compliance perspective. Preceding the development of the concept designs, consideration is given to developing a “model venue on accessibility” that highlights the venue accessibility components that should be common across all venues.
- The procurement and installation of technical equipment necessary to meet the needs of persons with a disability is part of the venue design and planning process.

## **7.3 STAFF AWARENESS AND TRAINING**

The OCOG organises and delivers high quality, well delivered disability and accessibility awareness training to all Games workforce. The aim of this training is to enhance the understanding of all Games workforce about persons with impairment and demystify the issue of disability, as it is often attitudinal and communications barriers, as well as misconceptions and stereotypes, that form barriers and obstacles even more difficult than architectural ones.

The main recipients of such training are OCOG staff members, Games volunteers and contractors. The delivery of the training involves three main phases:

- General disability awareness training
- Games/job specific disability awareness and accessibility training
- Venue-specific accessibility training

The training provides participants with the tools and confidence to apply the learnings into their Games-time roles, thus enabling all OCOG staff, partners, contractors and stakeholders to offer outstanding services to the athletes participating in the Paralympic Games as well as efficient services to other persons



with disability attending both the Olympic and Paralympic Games in various capacities (e.g. spectators, media, VIPs).

### **7.3.1 TRAINING THEMES**

Accessibility and disability awareness training in past Games have incorporated the following themes into their programmes.

#### **Concentrate on the person rather than his or her disability.**

- People who have a disability are, foremost, people. The emphasis should always be about the person rather than their impairment.
- Use people first language, which focuses on the person, not the disability. For example, when referring to a person with a disability, refer to the person first by using phrases such as: “a person who...”, “a person with...” or “person who has...”
- When describing objects and areas, emphasises their function. For example, “accessible parking and bathrooms” rather than disabled/handicap parking or bathroom.

#### **See the person first and foremost.**

- Be aware in your Games environment that you may encounter people with disabilities as athletes, spectators, paid staff, other volunteers or members of the public. Their needs may be different, your approach should not!

#### **Do not feel sorry for people with a disability.**

- The people with disabilities you meet are either colleagues here to work, spectators here to have a great time, or athletes here to compete. They are not people worried about their disability who require your pity.

#### **Remember that not all people with disability are wheelchair users.**

- Although 10% of the population has a disability, only about 0.6% of the population are permanent wheelchair users. People with disabilities could have any one of a range of other impairments. For example, there will be people with a visual impairment, people with mobility impairment who may use a walking frame or crutches, or people with a learning impairment. In addition, there are many more people with an ‘invisible’ disability, such as arthritis or a hearing impairment.

## Communicating.

- Good communication is important when assisting any customer. However, this is particularly important for some people with a disability, such as those with a visual or a hearing impairment.

When you meet a person with disability:

- Always address the person directly.
- Do not speak to somebody accompanying a person with a disability about an issue concerning the person with a disability.
- Ensure the way you address people with disability is respectful.

When you are listening:

- If the person has a learning impairment or speech impairment, be aware that it may be necessary to wait longer than you are used to for them to get their point across.
- Never finish someone's sentences for them, even if they have a speech impairment or learning impairment.
- Take a step back, so that a person in a wheelchair doesn't strain their neck when they are looking up at you.
- Always listen carefully and patiently to what the person is saying.
- If you have not understood them the first time, do not be afraid to ask them to repeat themselves for you. Alternatively, repeat back to them what you think they have said to make sure that you've heard them correctly.

When you are talking:

- People with a hearing impairment may need to lip read. If so, face the customer directly and do not conceal your face when you speak (i.e. keep your hand away from your mouth).
- Be aware that bright sunlight or shadow can obscure expressions, making lip-reading difficult.
- Speak clearly at your normal speed and tone of voice, unless the person specifically asks you to speak louder or slower. Move to a quieter location - or shut the doors - if necessary.
- Use straightforward, short sentences.
- If the person has not understood you, do not be afraid to repeat what you have said. Try re-phrasing and check if the person understands you.
- It particularly helps some hearing-impaired people, and people with learning difficulties, to use hand gestures to clarify your message. Using a map to show directions also helps.
- If you have not been understood, offer to communicate with a pen and paper instead.
- Use positive sentence construction, such as "Are you looking for the seating area?" rather than "You're not looking for the seating area are you?"

### **Assisting a person with a disability**

- There are few instances where this will be necessary but it is vital to understand what to do and what not to do when called upon.
- Do not assume that a person with a disability needs assistance because they have disability.
- What looks like a struggle to you may simply be someone managing perfectly adequately at their own pace, in their own way. Always ask first, and if help is not required then simply accept the response. Do not impose your assistance and do not take offence if your offer is refused.
- Never touch a person with a disability, or their mobility aid, without their permission. It is impolite and may affect their balance.
- Be proactive and offer assistance if you think it is required.
- If someone needs assistance to the seating area or other facilities in the venue you can call on your Team Leader for assistance if you are unable to leave your position.

### **Assisting wheelchair users**

- If a wheelchair user requests assistance, ask where the person wants to go, then inform the person that you are about to push them.

### **Assisting people with a visual impairment**

- When escorting somebody with a visual impairment, allow them to grip your elbow and walk beside you (if they have a guide dog they may prefer to walk free from contact).
- Always describe where you are walking, e.g. "Another few feet and we will be walking down a ramp", "We are approaching some stairs".
- When you reach your destination, let the person know where they are. You may need to ask another staff member to take over.
- If the person has a guide dog, do not pat it as this distracts from its work.

### **Venue-specific information**

- Cover in detail accessibility to mainstream facilities and also the additional venue facilities and services for people with a disability and other persons with reduced mobility.
- Incorporate a tour of accessible features and services; advice on protocols for using services; evacuation of people with a disability in emergency situations; likely venue specific scenarios.

## **7.4 GAMES INFRASTRUCTURE**

This section includes a description and discussion of the accessibility standards and considerations related to the design and construction of the venues that will host the Olympic and Paralympic Games.

Venues are classified as follows:

1. Olympic and Paralympic competition venues (indoor, outdoor, road).
2. Olympic and Paralympic Village.
3. Non-competition venues (official hotels, MPC, IBC, accreditation venues, airport, etc.)

There may be references to characteristics and differences related to existing and new venues, as well as to permanent and temporary facilities and overlays.

It should be noted that the design standards considered suitable for each kind of venue are not to be compromised or altered in the case of existing or temporary facilities. However, in cases where reaching optimum accessibility conditions in existing or temporary venues present an unjustifiable hardship for the OCOG, it will be up to the OCOG accessibility advisory structures and ultimately the IOC and the IPC to assess and approve alternative solutions or exemptions.

### **7.4.1 COMPETITION VENUES**

The various areas of a competition venue need to provide for every constituent group to effectively perform their role and/or enjoy the competition without obstacles. The technical design standards specified in Chapters 3 to 6 are applied in all competition venues to make them suitable to host the Olympic and Paralympic Games. The main venue areas, described below, allow the independent and dignified flow of members from any constituent group through the Olympic and Paralympic venues. For each venue area, the main accessibility principles are provided.

It should be noted that accessibility for the Olympic and Paralympic competition venues is not only about meeting specific design standards, but also about responding to the specific operational needs of a particular sport. For example, during the Wheelchair Basketball Finals, additional accessible spectating athlete seating is provided to allow all same sport athletes to sit together. Even if the spectator accessible seating capacity of the venue meets standards, using these accessible seats for the same sport athletes puts too much reliance on lift capacity and removes seating from paying spectators and different sport spectating athletes.

### **7.4.1.1 TRANSPORT DROP-OFFS**

Transport drop-offs for all stakeholders are located as close to seating areas as possible in order to minimise travelling distances. If the distance from the transport drop-off to the venue entry is greater than **500m**, or the route has steep ramps, provisions are in place for people with mobility limitations to transfer to/from the venue entry. Such provisions could be golf carts, low floor shuttle buses, etc.

For people with visual impairments or blind, tactile indicators or other suitable means for enabling independent travel are provided, connecting the main transport access points to at least one public entrance to each venue, preferably the principal entrance.

### **7.4.1.2 PARKING AND LOADING ZONES**

Parking on site, and/or loading and unloading zones, are provided at all competition venues and are allocated according to various constituent groups, based on their needs and function.

#### **Car parking areas**

Typically, parking for spectators is not provided, under the assumption that spectators will use public transport or active travel.

However, some venues may not be adequately served by accessible public transport. In such cases, controlled parking for persons with a disability is provided. For this purpose, a booking system may be arranged. The amount of parking spots provided is equal to the accessible seating provided in the venue concerned.

In car parking areas provided for other stakeholder groups, adequate space is reserved for accessible vehicles at a minimum of 3% of available spots or according to the needs. These spaces are located at convenient points for the user, considering proximity to:

- Pedestrian entries and exits
- Lifts and ramps
- Accessible toilets
- Pay stations

For specific information about parking, see Section 6.3 Parking.

#### **Loading zones**

Loading and unloading zones are in areas with zero or low slopes (up to 2%). If low-floor accessible buses are used, provisions for suitable pavements with associated kerb ramps or temporary ramps and landings are made. For specific information about loading zone design, see Section 4.8 Transport load zone.

### **7.4.1.3 VENUE ENTRY**

In the context of the Olympic and Paralympic Games, different entries are provided depending on the stakeholder group. Main venue entries for all groups are accessible, taking into account the operational needs. Special consideration is required for athletes' entry, as during the Paralympic Games the demand may be significantly higher. In the venue planning process, suitable athletes' entry requirements should provide primarily for the needs of the Paralympic Games in terms of access in order to minimise changes during the transition period.

#### **Ticket box offices**

The following provisions are made at ticket box offices to allow for proper access and circulation:

- Accessible queuing areas
- Accessible counter height and length
- No step or other obstacle preventing a wheelchair user to approach the counter
- Assistive hearing devices installed at every group of ticket box offices, to assist people who have limited hearing capacity

#### **Entrances**

In the Games context, controlled entries may include the following:

- Staff entrances, with associated check-in and check-out points
- Ticketed spectators' entry points
- Other stakeholder groups entry points (with accreditation checking)
- Exit points

The route connecting workforce entrances to and from the workforce check-in and check-out areas is accessible. The configuration of the workforce check-in and check-out areas allows for a workforce member who uses a wheelchair the ability to enter, manoeuvre and exit the area.

All controlled spectator entries and exits are accessible. In all spectator entry points a minimum one gate should be at least **1,000mm** wide and without an installed magnetometer device. Security screenings at this gate will be performed via a portable magnetometer.

In the case that not all entries and exits are accessible, those that are accessible are clearly indicated with the international symbol for access and are visible from a distance. Directional signage pointing to the closest accessible entry are required in all non-accessible entries.

## Pathways

All principal footpaths and circulation paths are a minimum of **1,800mm** wide (to allow two wheelchair users to pass) and have a maximum of **1:20 (5%)** inclination.

The OCOG provides accessible pathways by ensuring:

- Elimination of tripping hazards
- Surfaces that are slip resistant and not reflective
- Pathways in areas catering to a large number of pedestrian traffic are at least **2,000mm** in width to allow at least two wheelchairs to pass when crossing
- Ramps (and kerb ramps) meet the best practice design requirements, which is 1:20 (5%); this standard is obligatory for all primary entrances and facilities
- Where ramps are provided, adjacent stairs are also provided for those who have difficulty walking up or down ramps
- Stairways meet best practice design element requirements

**EXCEPTION:** Variations to this standard may be considered as an exception, subject to provision of full justification that adherence to the 1:20 standard is impossible or presents an unjustified hazard. For secondary or ancillary facilities, a slope of 1:14 is acceptable as minimum, again if 1:20 standard is not attainable.

For specific information regarding routes, see Chapter 4 All accessible routes.

### 7.4.1.4 FUNCTION AND SERVICE AREAS

The members of each stakeholder group have a wide range of functions to perform within a competition venue. While these functions differ among the groups, several of the following functions are performed by at least one group: work, officiate, relax, warm up, compete, change clothes, have a shower, watch the competition, buy products, access services (food, medical, information, toilets) and more. In order to be able to perform all these functions, there needs to be provisions that allow access to the respective areas and services. These are:

#### Doorways and doors

The clear width of doors meet the accessible design requirements. For certain competition venues, door width of athletes' preparation areas increases to **1,000mm** in order to allow access for athletes in competition.

All doors are capable of independent operation, except where this conflicts with building codes or fire regulations. Push-plates are provided on push-open doors.

For specific information about doorways and doors, see Section 3.2 Doors, doorways, and gates.

## Elevators and lifts

Lifts are used to access venue areas when the vertical height difference cannot be addressed with ramps. While it is best practice for the size of an elevator car to be **1,700mm x 1,500mm**, for facilities with high public use, such as major sporting event venues, the elevator car size increases to a minimum of **2,100mm x 1,500mm**. For specific information on accessible elevator features, see Section 4.7 Elevators.

## Toilets

At least one accessible toilet is provided in every bank of toilets and is gender-neutral. If this provision is met, any toilets in excess of this number can be in gender specific areas. For additional details on accessible washroom design, see Section 5.3 Toilet compartment and cubicles.

## Service counters

The main service area of reception, registration and other counters fulfil the design elements in Section 3.5.2 Table and counters. Where possible, reception and service counters are one height that is universally accessible to all people.

## Signage

All accessibility related signage is clear and legible and incorporates the appropriate international symbols and pictograms, in addition to any words. This signage is provided at regular intervals, but at least at every major change of direction and has a minimum **30%** luminance contrast. Signage specifications, including height and character size, are provided in Section 4.9 Signage wayfinding and public spaces .

## Telephones

Accessible public telephones provide a means of communication for all members of the public. The keypad or telephone handset is placed at **1,200mm** above the ground. In every bank of telephones at least one telephone is wheelchair accessible and clearly identified by the international symbol of access.

## Emergency provisions

Either accessible emergency egress or a fire evacuation area is provided in every area of the venue. Fire evacuation areas are either:

- Located within an exit
- Adjacent to a path of travel to an exit
- External to a building



- Open space on the roof of a building

The members of the Venue Team in charge of emergency evacuation are aware of such provisions. Accessible emergency egress or a fire evacuation is specifically planned and tested prior to the events. Additionally, the fact that a high number of people with mobility impairments will be present for Paralympic Games is incorporated into the emergency evacuation plans. Event-specific emergency evacuation plans may be required especially for the Paralympic Games, depending on the actual configuration of the venue and applying safety regulations.

A suitable visual system is provided in all main areas to allow people who are deaf/have a hearing impairment to respond to emergencies. This includes the use of scoreboards or video screens where provided or appropriate.

#### **7.4.1.5 SEATING AND STANDING AREAS**

##### **Spectators' seating**

The OCOG provides high-quality accessible seating spaces for spectators with reduced mobility, ensuring the best possible solution for each competition venue, on a venue by venue basis appropriate to the sport.

At open air, cross country, winter and summer sports (such as biathlon, mountain biking, etc.), dedicated raised platforms are provided at key points for spectator viewing. These platforms are made available to wheelchair users and other spectators who cannot stand for long periods.

##### **Calculating the number of spectator accessible seats**

**Table 8: Calculation spectator accessible seating**

Games seated Capacity	Number of accessible seats	Number of accessible seats for wheelchair sports
Under 10,000	1% of Games seated capacity	1.2% of Games seated capacity
10,000 - 19,999	100 plus 8 seats per 1,000 above 10,000	120 plus 10 seats per 1,000 above 10,000
20,000 - 39,999	180 plus 5 seats per 1,000 above 20,000	220 plus 5 seats per 1,000 above 20,000
40,000 or more	280 plus 2 seats per 1,000 above 40,000	320 plus 2 seats per 1,000 above 40,000

The following table presents an application of Table 8: Calculation spectator accessible seating.

**Table 9: Spectator accessible seating at the Olympic and Paralympic Games**

Games seated capacity	Number of accessible seats	Number of accessible seats for wheelchair sports
3,000	30	36
5,000	50	60
7,500	75	90
10,000	100	120
15,000	140	170
20,000	180	220
25,000	205	245
30,000	230	270
50,000	300	340
75,000	350	390

The figures above do not include the number of accessible seats for accredited groups such as Games Family, Media or athletes. The specific numbers vary from venue to venue depending on the sport and is confirmed with the IPC for each Games edition.

Additional considerations are made for venues where standing tickets are sold to ensure accessible viewing areas as discussed in Section 3.6.2 Sight lines.

The location of the seating positions enables the spectator to sit with and interact with their own group; for example, members of the Paralympic Family in standard seats are co-located with colleagues in the Paralympic Family accessible seats.

The designated accessible seating area provides:

- A levelled area
- A space of **800mm x 1,300mm** for the spectator.
- An adjacent area of **500mm x 1,300mm** for companion or enhanced amenity seat.
- Circulation space behind of **1,000mm minimum** to allow the user to comfortably manoeuvre into the space.
- Therefore, the overall space required for an accessible seat and companion seat with a pathway behind is: **1,300mm x 2,300mm**.

Best practice is to provide loose companion seats to facilitate flexible seating arrangements. This allows venue staff to quickly and easily switch between providing either banks of accessible seating spaces, single accessible seats with a companion, family groups including a wheelchair user, or a group of wheelchair users.

When calculating the number of spectator accessible seats per venue, the OCOG takes into consideration the overall service levels that are available to ensure accessible transport options, accessible entrances, security checks, concessions, washrooms, etc. meet the needs of the projected number of spectators.

**EXCEPTION:** Within existing venues being modified for Paralympic use, it may be permissible for organising committees to negotiate a different number of accessible seats from the suggested figures. The organising committee should formulate a proposal based on expected demand, with the intension of achieving as near to the optimum requirement while continuing to offer an excellent view of the field of play and a range of seating options.

### Enhanced amenity seating (EAS)

Enhanced amenity seating allows greater width in front of, or at the side of, the seat to allow for people with reduced mobility, such as those who use guide dogs or have crutches or walking frames. An amount of EAS at least 1% on venue's net capacity is provided, in addition to wheelchair positions and companion seating. EAS is equitably distributed and located at the ends of rows and up or down as few steps as possible. These can also be used as contingency for people whose standard seat is not appropriate due to safety or comfort reasons.

### Comparable sightlines

Comparable sightlines provide the same sightline for a person seated in a wheelchair when a person in front stands up as the person in front has when standing.

**EXCEPTION:** In existing or temporary facilities, when providing comparable sightlines is technically challenging and is combined with a sport in which the likelihood of the audience standing up during the event is low and the impact on the remainder of the seating is high, an exemption may be considered. In this case the sightline for the wheelchair accessible position is the same as the person in front has when seated.

### **Accredited seating**

A specific area in the stands is reserved as seating for accredited groups (athletes/team officials, technical/Games officials, Olympic/Paralympic Family, press and broadcasters).

Adjacent companion seats are not always essential in areas reserved for groups of accredited customers, such as broadcast and press areas.

For the Paralympic Games a defined number of accessible accredited seats per sport per client group is specified by the IPC for each Games edition.

#### **7.4.1.6 EVENT EXPERIENCE AND COMMUNICATION**

A hearing augmentation system, available for seats in all ticket price categories, is provided in public areas so that people who are deaf or have a hearing impairment are able to equally enjoy the event and its presentation and participate in all activities.

Any scoreboard or video screen capable of displaying public announcements is used to supplement the public address system.

People with a disability have equal access to publications addressed to the public, such as daily programmes, etc. Alternative formats of such publications (example: large print, audio, Braille) are available upon request at the venue's spectators' information points.

## **7.4.2 OLYMPIC AND PARALYMPIC VILLAGES**

An accessible Olympic and Paralympic Village(s) allow the athletes and other residents to prepare for the Games without any limitation or impediment. In addition, it creates an opportunity and a real-life example of a type of community that can be inclusive for all its members.

### **7.4.2.1 MAIN DESIGN DIRECTIONS FOR OLYMPIC AND PARALYMPIC VILLAGES**

The development of the Olympic and Paralympic Village(s) delivers an accessible site without excessive cost and without compromising its appeal to potential investors following the conclusion of the Games.

#### **Accessible and adaptable features**

For the Village to achieve the aforementioned goals, it contains both accessible and adaptable components of accessibility:

- Accessible features are included in the base building works and generally cannot or do not need to be changed during the Games.
- Adaptable features allow additional elements such as handrails, shower seats, visual alarms and communications to be installed 'as required' during the transition period. These elements may be removed following the conclusion of the Games but can be re-installed should future residents require them.

Other villages applicable in the Games context, such as accommodation for remote sports (e.g. sailing, equestrian), technical officials' village and media village also consider accessible and adaptable elements of design to ensure all people can use and enjoy the facilities appropriately.

#### **Life-time design**

A solution to this challenge can be the adoption of a planning strategy called 'life-time design'. This strategy designs infrastructure for long-term users (such as residences) whose key planning parameter is to be able to meet the needs of its users throughout their life cycle (from infants to the elderly).

#### **When to install accessibility features**

Although all villages should be accessible, athletes' village planning should be based on the needs of the Paralympic Village, as the demand for accessibility provisions and operations is higher than during the Olympic Games. The Paralympic Village is expected to host 8,000 people (including 1,900 wheelchair users) at the Paralympic Summer Games and 2,200 people (including 450 wheelchair users) at the Paralympic Winter Games.

Indicatively, in past Games, the breakdown of the Paralympic Village's residents as regards to impairment type was as follows:

- 400 athletes using a powered wheelchair;
- 1,500 athletes using a manual operated wheelchair for daily living;
- 500 blind/visually impaired athletes; and
- 1,200 athletes with other mobility impairments.

Therefore, best practice has established that the vast majority of accessibility features required for the Paralympic Games should be already installed prior to the Olympic Games to minimise transitional operations.

The requirements related to Paralympic Village(s)' capacity for residents are specified in the HCC - Operational Requirements.

#### **7.4.2.2 PROVISIONS OF AN ACCESSIBLE VILLAGE**

An accessible village provides:

- Pathways and circulation spaces of appropriate width to allow wheelchair users to pass.
- Adequate street lighting to allow people with a visual impairment to move with safety.
- All building and housing main entrances that are accessible to wheelchair users.
- Roadway crossings and kerb ramps that allow wheelchair users to transverse street crossings to key facilities and internal transport, following the natural pedestrian flows.
- Accessible internal transport stops with appropriate pathways to housing.
- Housing and accommodation that allows wheelchair users with and without carers to have fully functional and independent access.
- Lift access with appropriate capacity to ensure wheelchair users can efficiently move into and out of the accommodation at peak periods.
- Kitchens that allow wheelchair users to access hot and cold water, refrigeration and access to a snack/meal preparation area.
- For every location of stairs, an alternative ramped or lift option is available.
- Accessible transport links to external transport.
- Accessible transport links with the venues.
- Staff and volunteers who are aware of the accessible operations and infrastructure.

### **7.4.2.3 VILLAGE'S RESIDENTIAL AREAS ACCESSIBLE ACCOMMODATION TYPES**

Ideally, all accommodation facilities in the Village are accessible or adaptable.

Indicatively, the key elements of adaptable accommodation are:

- Limited or no threshold steps at the entry door.
- Appropriately graded pathway from the street and/or corridor.
- Doorways of suitable width with enhanced latch-side clearance for exiting.
- Bathrooms that have studs in the walls, where - if needed - a grab rail could be installed; basins and vanities that can have the cupboards underneath to allow appropriate knee clearances.
- If in a house-type accommodation, all rooms on the ground floor are accessible.
- Open-plan circulation to the kitchen and lounge area.
- No threshold steps leading to the outside entertainment area.
- Access to the clothesline and laundry appliances.

The key elements of accessible accommodation include the above adaptable features and:

- Doorways with enhanced latch side clearance for exiting;
- Open-plan bathrooms that have the toilet pan, stepless shower and basin in one room and the studs are pre-placed in the walls;
- Kitchen benches at the appropriate height and the possibility of the doors removed to allow for circulation underneath it by a wheelchair; and
- Power points raised above the floor level to allow enhanced reach by people with mobility impairment.

Additional aids that can be employed on an 'as needed basis' include:

- Commodes (wheelchair seats on wheels)
- Raised toilet seats
- Bathtub seats, when a bath is provided instead of a shower

For specific information on accessible accommodation layouts, see Section 6.6 Hotel and for information on accessible bathrooms refer to Section 5.3 Toilet compartment and cubicles.

#### **7.4.2.4 VILLAGE'S SERVICE AREAS**

Accessibility provisions, both technical and operational, for some of the main service areas of the Village are:

##### **Dining areas**

- Main and secondary entries that are accessible, including emergency evacuation routes.
- Staff assistance for bag storage.
- Storage for sporting wheelchairs and equipment in close proximity.
- Appropriate serving and food display heights (at **850mm**).
- Volunteer assistance with carrying food and drinks.
- Provision of accessible toilets (ratio 1:25).
- Tables of appropriate height (max. **850mm** height with **750mm** knee clearance).
- Main pathways and aisles of a minimum of **1,500mm** wide.

##### **Entertainment areas (e.g. cinema, dance hall)**

- Ramped or lift access, if located on a floor other than ground.
- Wheelchair seating spaces with an adjoining companion seating place as near to the middle of the cinema as possible.
- Hearing augmentation system to enhance the soundtrack.

##### **Wheelchair, prosthetic and orthotic repair centre**

- Rest seating for wheelchair users who have to transfer from their chairs.
- Shade and shelter.
- An accessible reception desk. For specific information, refer to Chapter 3 Venues interior elements requirements.

##### **Welcome centre**

- Low counter or lower part of a counter at welcome desk for wheelchair users.
- Rest seating within the foyer for waiting visitors.

##### **Team welcome ceremonies area**

- Wheelchair seating spaces within the auditorium.
- Hearing augmentation system to enhance public announcements.
- Ramped access to stage areas and flag raising areas.
- Ramped access to performance stages for performers with a disability.
- A reasonable amount of shelter at the welcome stage.

##### **Village plaza areas (e.g. shops, internet cafes, recreation centres)**

- Accessible alternatives to installed magnetometers at the entries.



- Appropriate width of aisles.
- Distribute goods vertically and have staff assistance for high sections of displays.
- A wide enough check-out aisle for wheelchair users.
- Appropriate circulation spaces and pathways.
- Desks which are height adjustable.
- Computers with accessibility provisions, e.g. large font, screen readers.
- Gym will have sport-specific equipment such as hand ergometers.

### **Other accessible operations**

During their stay, the residents of the Olympic and Paralympic Village(s) will engage in a series of tasks that need to be performed with ease and independence regardless of any type and degree of impairment. These tasks include:

- Preparing mentally and physically for competition (e.g. access weight training, attend team meetings, get equipment maintenance and repair)
- Dine
- Wash clothes
- Socialise
- Interact with friends, family or others
- Sleep and rest

All these tasks need to be feasible to be managed and performed independently by all residents. For this to be realised, several operational considerations need to be taken into account to strengthen the accessible components of the Olympic and Paralympic Village:

### **Staff awareness and training**

An integral element of the village is the appropriate awareness and training assistance of staff and volunteers. Their appropriate attitude and actions are necessary for a wide range of services, including:

- Set-up of accessible housing to ensure residents are comfortable
- Security scanning at main transport mall entry and the international zone
- Assistance at main and casual dining with food service, or delivery to tables
- Assistance with storage of equipment and bags
- Assistance with washing and drying within the residence centre
- Assistance with order taking and serving within the international zone, such as at an internet café

For specific information about disability awareness training, see Section 7.3 Staff Awareness and Training.

## Information provision

Develop a Village Manual for all residents to ensure they are aware of the infrastructure provided within the village.

### **7.4.3 NON-COMPETITION VENUES**

In a similar way to competition venues and the village(s), the non-competition venues allow their users to fully perform their duties at the Games, regardless of physical or sensory limitations. The design standards for accessibility for public areas and buildings, presented for the competition venues and the Villages, also apply for the non-competition venue.

The non-competition venues discussed in this section are:

- The Main Press Centre (MPC)
- The International Broadcast Centre (IBC)
- The Accreditation Centres
- The Official Hotels
- The Main Airport

#### **7.4.3.1 MAIN PRESS CENTRE (MPC)**

This is the main workplace for the accredited press and photographers covering the Games and is seen by them as their “home away from home”. The basic services, facilities and telecommunications needed to cover the Games are located within the MPC.

The main services provided in the MPC for the media are:

- Working space and telecommunications, including workstations, INFO system terminals, results distribution.
- Separate workstations for photographers, including digital disks services laboratory.
- Help Desk services, such as providing general information, transport schedules, handling accreditation issues.
- Press conference rooms.
- Other potential services, such as a bank, travel agent, general store, technology store, pharmacy, post office, newsagent with foreign papers, coffee bars, and a catering area with both fast food and restaurant services.

#### **Characteristics of an accessible MPC**

An accessible MPC provides:

*For the media work areas*

- Pathways and circulation areas of appropriate width to allow wheelchair users to pass.
- Adequate internal and external lighting to allow people with a visual impairment to move with safety.
- Accessible main entrances.
- For every location of stairs, an alternative ramped option or a lift.
- Staff and volunteers that are aware of the accessible operations and infrastructure.
- Accessible furniture and equipment throughout the workplace(s).
- Telephones with adjustable volume control and with a flux coil to assist users with hearing impairment.
- Telephones equipped with TTY devices located in the workplace seated configurations.
- Directional signage indicating the presence of TTY (TDD) equipped phones utilizing the international symbols for identification.
- One printer able to print in Braille, linked to one INFO terminal.

#### *For the Help Desk*

- Service areas for each individual service with a lower part of the counter at least **1,000mm** and at a height of **850mm**, with **750mm** knee clearance, above the floor.
- Availability of standard information elements (such as transport schedules) in alternative formats (e.g., audio, large print, Braille) upon request.

#### *For the Press conference areas*

- Accessible ramp leading to the elevated press conference table.
- Hearing augmentation system, for press representatives who have hearing difficulties.

#### *For other services and areas*

- Shops that fulfil accessibility standards for entrances, corridors, service counters, and displays.
- At least one gender-neutral accessible toilet in every bank of toilets, with appropriate signage.
- Visual fire/emergency alarms in public areas, washrooms and in front of elevators.
- Evacuation planning and equipment that considers people with a disability.
- Temporary drop-off parking spaces designated for people with a disability.
- Loading and unloading zones in areas with zero or low inclination. Reserved parking area for customers with a disability, at a minimum of 3% of total car spaces.
- Clear arrival, exit and directional signage, legible in all light conditions.

### 7.4.3.2 INTERNATIONAL BROADCAST CENTRE (IBC)

The IBC is the hub of the Games' image to the world. The international and/or multilateral signal generated at each venue is produced by the host broadcaster and transmitted from the venues back to the IBC. From there it is transmitted to the world via optical fibres or satellite earth stations. With this signal, radio and television Rights Holding Broadcasters (RHBs) can tailor the picture and sound to fit their requirements and spread the message and images of the Games to the global audience.

In addition to the technical installations necessary for production and transmission, services of the IBC include:

- Studio space, bookable by RHBs
- Bookable announcer positions
- Daily briefing room
- Broadcast services office
- Guest pass and information offices
- Support services, such as food court, restaurant, ATM, courier services, medical centre, language services

#### Characteristics of an accessible IBC

- Pathways and circulation areas of appropriate width to allow wheelchair users to pass.
- Adequate internal and external lighting to allow people with a visual impairment to move with safety.
- Accessible main entrances.
- Alternative ramped option or lift available for every location of stairs.
- Staff and volunteers that are aware of the accessible operations and infrastructure.
- Visual fire/emergency alarms in public areas, washrooms and in front of elevators.
- Evacuation planning and equipment that considers people with a disability.
- Temporary drop-off parking spaces designated for people with a disability.
- Telephones with a flux coil to assist hearing aid users.
- Telephones equipped with TTY and adjustable volume control devices located in the workplace seated configurations.
- One printer able to print in Braille, linked to one INFO terminal.

*For the broadcast, guest pass and information service offices*

- Service areas for each individual service with lower part of the counter at least **1,000mm** and at a height of **850mm**, with **750mm** knee clearance, above the floor.
- Availability of standard information elements (such as transport schedules) in alternative formats (e.g., audio, large print or Braille) upon request.

*For the daily briefing area*

- Hearing augmentation system for broadcasters' staff with hearing difficulties.

*For the support services and other areas*

- Shops that fulfil accessibility standards for entrances, corridors, service counters, and displays.
- At least one gender-neutral accessible toilet in every bank of toilets, with appropriate signage.
- Loading and unloading zones in areas with zero or low inclination; reserved parking area for customers with a disability, at a minimum of 3% of total car spaces.
- Clear arrival, exit and directional signage legible in all light conditions.
- Accessible pathway to the medical areas.

### **7.4.3.3 ACCREDITATION CENTRES**

The entire Olympic and Paralympic Family, as well as the Games Workforce will need to go through the various accreditation centres to receive their credentials that will allow them access to the appropriate venues and areas to perform their roles.

This operation occurs at the various accreditation centres, which are:

- Main Accreditation Centre, which may also be referred to as 'Uniform Distribution and Accreditation Centre' (UAC). The workforce accreditation, and the distribution of the uniforms to workforce and technical officials, occurs here.
- The Village(s) Accreditation Centres, for delegations' registration and credentials validation.
- The Airport Accreditation Centre, for validation of the pre-issued accreditation cards.
- The Media Accreditation Centre, for press and broadcasters, typically located close to the MPC and the IBC.
- The Olympic/Paralympic Family Accreditation Centre, usually located within or next to the Olympic/Paralympic Family hotel(s).

#### **Characteristics of an accessible accreditation centre**

- Car parking area reserved for people with a disability, fulfilling accessibility standards.
- An accessible pathway link from surrounding pedestrian pathways, including appropriate signage.
- Entry and exit points wide enough to allow two wheelchair users to pass while crossing each other.
- Pathways and circulation areas of appropriate width, including the internal routes leading to the various service areas.
- Configuration in the ground level, for all clients.

- Service areas at a height of **850mm, 750mm** knee clearance, above the floor, for each individual service, or at least with a lower part of each counter for at least **1,000mm**.
- Availability of standard information elements (such as staff guide) in alternative formats (e.g., audio, large print, Braille) upon request.
- Tactile ground surface indicators marking the route to the service counters.
- At least one gender neutral accessible toilet in every bank of toilets, with appropriate signage.
- Clear arrival, exit and directional signage legible in all light conditions.

### Considerations for specific accreditation centres

For the Main Accreditation Centre (or UAC)

- Accessible uniform testing room, allowing self-handling.
- Staff assistance for uniform items collection, when required.
- Low counter throughout the uniform pick-up areas.
- At least one gender-neutral accessible toilet at the waiting area.

For the Airport Accreditation Centre

- Accessible route from/to the baggage claim area.
- Pathway in front of the service counters of at least **1,800mm**, to allow easy passage of wheelchair users.
- Staff assistance for handling baggage while being served.

For the Village(s) Accreditation Centre

- Wide waiting area to accommodate enhanced space demand (for Paralympic Village period).
- Accessible doors and doorways allowing access to NPC officials for the delegation registration meetings.
- Staff assistance for baggage security screening and loading/unloading to buses.

#### **7.4.3.4 OFFICIAL HOTELS**

The senior officials of the Olympic and the Paralympic Family are accommodated in the official hotels. The official hotels fully comply with the accessibility standards in this Guide, as several members of Olympic Family and many Paralympic Family members use a wheelchair for daily living or have other physical or sensory limitations. For specific information about accessible accommodation, see Section 6.6 Hotel.

#### **Olympic Family Hotel/Paralympic Family Hotel**

In addition to providing accommodation for the Olympic and Paralympic Family, the Olympic Family Hotel (OFH) and Paralympic Family Hotel (PFH) serve as the

headquarters for the IOC/IPC during Games-time and host various events and meetings in the context of Games delivery.

Besides the standard hotel services, numerous other functions are provided there, such as:

- Accreditation centre
- Information desk
- Transport desk
- T1, T2, T3 load zones and shuttle buses
- Meeting facilities
- Working offices for the IOC and the IPC staff

#### **Additional accessibility features for Olympic/Paralympic Family Hotels**

In addition to the accessibility features in Section 6.6 Hotel, the OFH/PFH provides:

- Accessible pathways linking the hotel's main lobby and other areas to the services desks (accreditation, transport, information), the transport loading zones, the meeting rooms and the IOC/IPC offices.
- Service counters at the information desks fulfilling accessibility standards.
- Publications (such as Olympic/Paralympic Family Guides, transport schedules) available in alternative formats.
- Meeting rooms configuration allowing unobstructed access to all.
- One printer able to print in Braille, linked to one INFO terminal located in the main lobby or other prominent area of the hotel.

#### **7.4.3.5 AIRPORT**

The principal airport of the host city, although being already an existing operational facility, is considered a non-competition venue because of the increased demand put on its operations due to the Games.

The Olympic Games will result in:

- Significant increase in arrivals before and during the event
- Mass arrivals and departures of NOC delegations and Olympic Family members
- Additional operations (accreditation, Olympic protocol, dedicated transportation)
- Mass departures after the closing ceremony

The Paralympic Games will result in:

- Mass arrivals and departures of people with a disability (scope much higher than for any airport)
- Additional operations, same as for the Olympic Games

## Principles for accessible airport operations

The airport design and operation allow for maximum possible independent circulation of travellers regardless of physical or sensory limitations. For this to be feasible the design model used for modern terminal design should be expanded to include the facilities required for excessive use by people with a disability.

Accessible airport terminals require operators to challenge their assumptions about the range of motion and sensory capabilities of their customers. Signage and wayfinding are critical because they promote independent navigation and help shorten distances by directing users.

## Characteristics of accessible terminal facilities

Main elements of an accessible terminal:

- Disability awareness training for all front-line employees.
- Paths of travel serving the terminal, including connecting pathways to all parking that is accessible, safe and well signed.
- Well-lit pathways and parking areas.
- Accessible furniture and equipment throughout the terminal(s).
- Visual fire/emergency alarms in public areas, washrooms and in front of elevators.
- Evacuation planning and equipment that considers people with a disability.
- Dog relief station for use by certified service dogs or guide dogs.
- Temporary drop-off parking spaces designated for people with a disability on each level of the terminal buildings adjacent to the main doors. These 15-minute zones are intended to allow wheelchair users and other people with a mobility impairment time to more easily check-in or pick up their baggage without travelling to/from the longer-term parking.
- Each pay telephone in the terminal with adjustable volume control and a flux coil to assist hearing aid users.
- TTY (TDD) telephone equipment.
- Tactile lettering on service rooms (washrooms, holding rooms, etc.) and elevator signage.
- Audible, bilingual synthesized voice 'floor callers' in elevators - not just tones.
- Tactile maps of terminal area (available at customer services or through local organizations).
- High contrast, tactile hazard warnings on all stairs and drop-offs.
- High contrast/tactile floor wayfinding to assist users navigate through key areas.
- Low mounted information displays throughout the terminals.
- Low mounted, prominently located courtesy phones that connect directly to operations for detailed information.
- Accessible check-in and service counters with writing surfaces and toe clearances for persons using wheelchairs.



- Lowered fire alarm call buttons so that wheelchair users, people with short stature and those with poor range of motion or balance can trigger an alarm.
- Special consideration in the elevators such as:
  - Front and rear doors in elevators (allows flow through instead of having to turn around to exit)
  - Handrails for stability
  - Side-wall mounted operating panels
  - Accessible emergency communications in elevator cabs
- The use of carpet in the terminal is minimised. Where it is used, it is low pile style glued down directly without underlay, to reduce resistance for wheelchairs.
- Terminal seating that provides arm and back rests with appropriate kick-space underneath. Space should be provided for wheelchair users in these rest areas.
- Minimum aisle widths are maintained at **1,000mm**, with **1,500mm** turnaround in food and beverage outlets.
- Bars in lounges and VIP areas that have lowered sections for wheelchair users and/or people unable to use high stools.
- Restaurant and food court seating provides chairs with arms, and chairs without arms.
- Taps and paper towel dispensers in the terminals are equipped with hands-free operators.
- At least one urinal in each washroom installed with a lowered rim height of **400mm** above the floor and equipped with vertical grab bars.
- All accessible toilet stalls have an emergency call button in case of falls or other problems.
- Shuttle service (e.g., golf carts) for travel over long distances.
- Reduction of background noise for the benefit of people who are hard of hearing.
- The use of 'visual pagers' - essentially dedicated video monitors - that will carry written messages to notify people who are deaf, or persons with hearing difficulties, of important information and audible pages.
- The development of a video override system that, in the event of an emergency, can display a bold type message to all entertainment television/video screens/data monitors and visual paging monitors in the terminal buildings, indicating the type of emergency and a course of action to be carried out by the public. This message should be delivered in both audio and video modes in appropriate languages.
- The inclusion of closed captioning on all entertainment televisions in the facility.
- Low volume public address system utilising speakers placed approximately six meters apart throughout the terminal. This reduces the noise pollution and encourages hearing aid use.
- Distinct and consistent floor treatments to help users identify their location within the terminal by flooring material (e.g., carpet = gate, tile = exit, other surfaces = retail).
- Use of screen walls and the elimination of entrance doors on all common washrooms.

- Most banks of pay telephone units include a unit equipped with a seat for persons unable to stand for long periods, or persons using the TTY (TDD) features.

Special considerations for Paralympic operations:

- Adequate number of aisle chairs available to each airline (with adequate training on their use).
- Detailed plan for fast loading/unloading of flights with many wheelchair users (typically NPC delegations), using appropriate lightweight aisle chairs and relevant handling agencies staff training.
- Develop a Games-time service which reunites Paralympic team members with their wheelchair or mobility aid as close to the aircraft door and as soon as possible.

## **7.5 FUNCTIONAL AREAS CONSIDERATIONS ON OPERATIONS**

This section includes a detailed presentation of various OCOG Functional Areas (FAs) aspects of planning and operations that have considerations related to accessibility. When applicable, liaison with related public authorities is mentioned.

For each FA, three aspects are presented:

1. A functional area overview, so that the reader becomes familiar with its role and responsibilities.
2. Accessibility provisions required by the FA, in a Games-wide basis.
3. Paralympic-specific considerations based on the increased number of Paralympic Games stakeholders who have a disability.

For more detailed guidance and information, please refer to the FA-specific Olympic Games Guides.

### **7.5.1 ACCOMMODATION**

Accommodation is responsible for the development and execution of accommodation planning for certain categories of stakeholders, prior to and during the Games.

The Accommodation FA focuses on the procurement, contracting and distribution of hotels and rooms to various stakeholders groups and ensures the provision of accommodation services to the wider Olympic and Paralympic Families and other stakeholders as these are articulated within the Host City Contract.

Among others, it is responsible for:

- Planning and administration elements, such as contracts and guides.
- Managing the demand of the individual clients (contractual obligations) and the supply within the given environment, including managing the reservations.
- Facilitating the accommodation of certain visitors/spectators during the Games period.
- Resolving issues of accommodation during the Games period.

### **Accessibility provisions**

Hotel accommodation is an essential part of any city hosting the Olympic and Paralympic Games. During the Games, hotels address accessibility as a fundamental part of their amenities. Although usually only one facility serves as the official Paralympic Games Family hotel, accessibility considerations apply to all accommodations if a hotel wants to be considered by anyone coming to the event. For additional information about the Olympic and Paralympic Family Hotel, refer to Section 7.4.3.4 Official Hotels.

Accommodation supply rooms to various Games stakeholders: Olympic and Paralympic Family, broadcasters, press, sponsors, NOC/NPC officials, international federations, technical officials and workforce. The main categories of such sites are:

- The Olympic and Paralympic Family Hotel(s)
- The media accommodation
- The supplementary accommodation (for technical officials, broadcasters, workforce)

Each one of these sites fulfils the accessibility criteria for hotels, as outlined in Section 6.6 Hotel. In this regard, not only are the rooms accessible to all potential users, but also are the service and entertainment areas of the hotels. The arrangements take into account the access needs for the residents to perform their duties (such as meeting rooms, communication devices, information materials).

The Accommodation FA includes in the specifications for acquiring the hotel rooms all necessary provisions regarding accessibility in hotels.

In addition to the above, the Accommodation FA may undertake initiatives to promote and educate hotel owners and service providers about the market value of providing accessible rooms and services and about best practices to achieve this.

### **Paralympic considerations**

The demand in fully accessible and/or adaptable rooms in the Paralympic Family Hotel(s) is higher than any typical hotel may ever encounter during their years of operation. The selected hotel provides this number or commits to this during the tender phase.

Through structured communications means, such as questionnaires to the NPCs and the accreditation process, accurate data regarding demand of accessible rooms is captured for all stakeholder groups for which the OCOG needs to provide (or arrange for) accommodation. This data forms the basis for allocation of available rooms to the clients that need them.

Among other tasks, the Accommodation FAs undertake the following responsibilities related to accessibility:

- Seeking and booking accessible accommodation for pre-Games visits when required (such as, CoComs, NOC/NPC visits, IPC visits).
- Seeking information and contributing to the development of the pre-Games Training Guide, with regards to accessible accommodation linked to training sites in the host country.

During the Paralympic Games, a specified number of rooms at the Paralympic Family Hotel are fully accessible and wheelchair-friendly rooms. In certain cases, this can be split between one or two Paralympic Family Hotels. At least half of these rooms are fully accessible with roll-in showers. The remaining accessible rooms may be wheelchair-friendly rooms.

All hotels in the Olympic and Paralympic network have at least 1% of their rooms fully accessible.

The requirements for accessible rooms at the Paralympic Family Hotel are specified in the HCC - Operational Requirements

## **7.5.2 ACCREDITATION**

The Accreditation FA is responsible for identifying and registering in the accreditation system all individuals involved in the staging of the Olympic Games and the Paralympic Games. It produces, validates and delivers appropriate accreditation cards to all eligible participants, displaying their Olympic/Paralympic function and the venue access rights required for the performance of such function.

Accreditation works in co-operation with the Security Functional Area, especially in regard to card security components, clearances and access points.

Overall accreditation policy is determined by the IOC and the IPC (i.e. which applicants and participants are eligible, what access rights their function requires), and is applied by the OCOG. Workforce policy is generally established by the OCOG, based on recurring need for access, dependent on function and job type.

At Games-time, Accreditation operates all facilities necessary to ensure the registration of all participants and the production, validation and delivery of accreditation cards. For this purpose, a Main Accreditation Centre is established

(usually also acting as the Uniform Distribution Centre) plus Accreditation sub-centres (such as the Main Press Centre, the airport, the Olympic and Paralympic Village, the Olympic and Paralympic Family Hotels) and also at venue-based accreditation help offices. For specific information about accreditation centre considerations, see Section 7.4.3.3 Accreditation Centres.

### **Accessibility provisions**

In all accreditation centres accessibility is essential so that workforce members and the Olympic and Paralympic Family members who have mobility or sensory limitations are fully served. Elements of such an environment include:

- Signage with adequately big letters and strong contrast in colours.
- The path leading to accreditation areas and the path of customer servicing within those areas being wide enough to accommodate the flow of a person who uses a wheelchair.
- Where photos are taken, cameras that can tilt down and backgrounds are located low enough to serve wheelchair users.
- Entry points into accreditation facilities are at ground level and/or have adequate provisions (such as ramps) to facilitate independent access.
- Service counters are set up according to accessibility standards.
- Parking on-site for ad-hoc use, or in a pre-booking basis, provided for members of workforce who have a disability, as the Main Accreditation Centre may not be very close to public transport.

### **Paralympic considerations**

The accreditation centres servicing the athletes at the airport and at the Paralympic Village(s) have wider passageways and additional low service counters, in order to serve the peak demand during arrival days.

The accreditation application form has specific fields for applicants to indicate whether they are users of a wheelchair for daily living purposes. This information is essential for many other functions (accommodation, airport operations, Village operations, transportation, sports and others).

## **7.5.3 ARRIVALS AND DEPARTURES**

Arrivals and departures is an integrated end-to-end management process involving several OCOG FAs and external stakeholders. It comprises elements such as pre-Games communication, airports services, accreditation validation, transport, logistics and accommodation services to ensure the best experience to all accredited stakeholders.

The host city airport is the main gateway to the Games and the start of the Games experience. This will bring a considerable inflow of Games-related air passengers in addition to normal tourists or other passengers. Optimal airport operations are

aimed at providing a seamless flow from airside through the terminal buildings, with accreditation, customs, luggage recovery and transfer to appropriate Games' transport services on the landside.

A critical component of effective operation in the airport is the communication with various airline carriers to ensure the airport is aware of the numbers and types of passengers they should expect at various times in peak operations.

The Arrivals and Departures function of the OCOG works with the management of the airport to estimate the expected demand at the airport and facilitate the Games-related operations. For specific information regarding accessibility considerations at the airport during the Games, see Section 7.4.3.5 Airport.

### **Accessibility provisions**

The flow of the members of the Olympic and Paralympic Family through the airport in its Games-time operation provides unobstructed and independent access for all. For this purpose, a 'stakeholder flows' planning exercise takes place to ensure all pathways meet accessibility standards. Specific information about airport accessibility considerations can be found in Section 6.4 Airports.

### **Paralympic considerations**

The demand in accessible operations during the arrivals and departures days of the Paralympic Games are far beyond the usual scope of any airport in the world - especially at the Paralympic Summer Games, where in just two or three days more than 1,800 passengers who use a wheelchair will go through the airport. This presents a significant challenge for the airport in terms of resources and scheduling.

It is important to note that some Paralympic athletes will be travelling with an additional wheelchair that is specific to the sport in which they compete. These are extremely high-cost items and the athlete is depending on this wheelchair to compete, so it is a priority to ensure they are handled with care.

The Arrivals and Departures function is responsible for constantly providing up-to-date information (after liaising with other related Functional Areas within the OCOG, such as Olympic/Paralympic Family Services and NOC/NPC Services and Protocol) regarding numbers of wheelchair and other mobility aids users, and specific arrivals and departures times of NPC delegations and specific Paralympic Family members.

Also, the Arrivals and Departures FA interacts with Transport Operations so that the type of vehicles and the transport schedule reflect the anticipated needs.

The requirements for considering the provision of accessible arrivals and departure transport services for the Paralympic Games is specified in the HCC - Operational Requirements.

## **7.5.4 BRAND, IDENTITY AND LOOK OF THE GAMES**

Brand, Identity and Look of the Games is responsible for the visual and thematic representation of the Games, the host city and the country. It is an integrated communication platform that starts with Games emblems (Olympic and Paralympic) and related secondary emblems (such as those for the Torch relays, cultural, environmental and volunteer programmes, and the mascots).

The Look of the Games supports and extends the host city identity and Olympic and Paralympic image. The Look of the Games' design responsibilities include tickets, medal stands, banners, field-of-play graphics and sport pictograms. It lifts the presentation of the Olympic and the Paralympic Games in the competition venues, the common domain, non-competition venues and throughout the host city for the global broadcast audience, spectators, athletes, visitors, and local community.

### **Accessibility provisions**

Brand, Identity and Look of the Games ensures that all elements of the Look of the Games are as visible as possible for people with visual impairments. Therefore, accessibility standards regarding signage (such as colour contrast, size of letters, position of signs and posters) are taken into account when designing graphic elements and wayfinding signage. For specific information about wayfinding and signage, see Section 4.9 Signage wayfinding and public spaces

It is recommended that during the creation of the primary and secondary graphics manual the FA consults and interacts with the accessibility audit structures and/or experts of the OCOG to ensure suggested graphics meet accessibility standards.

### **Paralympic considerations**

The Look of the Games changeover from the Olympic to the Paralympic Games during the transition period, and renewal or replacement of damaged look elements, is a demanding task. Paralympic look elements and additional signage adhere to the same standards as the ones in place for the Olympic Games, with no compromises in terms of accessibility.

For the design and graphic elements for the Paralympic Games (such as tickets, uniforms, banners and backdrops), optimum visibility is considered even more important at the creative phase.

Because of the vital role signage plays in wayfinding, it is critical that consistency and accessible design are carefully considered before being implemented at the Paralympic Games.

## **7.5.5 BROADCASTING**

The Host Broadcaster is responsible for producing and distributing comprehensive and unbiased radio and television coverage of the Olympic Games and Paralympic Games. The coverage is provided as a service to broadcasters who have acquired the rights to broadcast the Games in their respective countries.

The international signal produced by the Host Broadcaster includes the camera outputs, audio signals and graphics generated at each venue.

This international signal, and the multilateral signal of some rights' holders, are transmitted from the venues back to the International Broadcast Centre (IBC) and from there to the world via optical fibres or satellite earth stations.

### **Accessibility provisions**

The IBC follows the same guidelines as venues described in this Guide. For specific information refer to Section 7.4.3.2 International Broadcast Centre (IBC).

The Host Broadcaster makes every effort to ensure graphics are readable by people with a visual impairment.

The commentators' part of the media stand has unobstructed access to media areas. Also, at least two spots in the commentators' positions are designated in the venue planning process ("accredited seating planning cycle") as being required to be accessible and kept reserved for broadcasters in every competition venue. This number may reach four for the opening and closing ceremony. The actual allocation of these spots will finally be made upon actual requests.

### **Paralympic considerations**

Some of the commentators' positions are wheelchair accessible, as several broadcasters use former athletes as commentators.

In venues where athletes compete in a wheelchair, the mixed zone is modified for the Paralympic Games in order to allow cameramen to shoot the athletes in optimum conditions. This may be facilitated with lower barricades (up to **60cm**) or a different setting of the mixed zone area.

The Host Broadcaster makes a conscious effort to educate the production crews about the differences of the Paralympic sports so that they can produce excellent footage, capturing the unique spirit of excitement and inspiration of the Paralympic Games.

## **7.5.6 CEREMONIES (OPENING AND CLOSING)**

The importance of an Opening Ceremony is paramount in defining and building the image of each Olympic and Paralympic Games, the host city and the host country.

The Closing Ceremony is the celebration of a successful Games. It is far more celebratory and less formal than the Opening Ceremony; it is a festive event to herald the Olympians and Paralympians, thank the host city and its people, and symbolically link the Olympic and Paralympic Movements to the next Games.

The task of the Opening and Closing Ceremony FA is to manage the creative, budgetary and spatial considerations in close co-operation with the producer and the management of the Olympic Stadium or other ceremonies' venues.



## Accessibility provisions

All elements of accessibility for the competition venues apply for the site of the Opening and Closing ceremony. For specific information on accessible considerations for venues, see Section 7.4.1 Competition Venues. All participants, especially spectators, members of the Olympic and Paralympic Families and the athletes fully enjoy the experience of the ceremonies, which is made possible through:

- Adequate accessible seating for the Olympic and Paralympic Family, as per the respective guidance from IOC and IPC and Table 7: Spectator accessible seating at the Olympic and Paralympic Games for spectator figures.
- Every spectator accessible seat having at least one adjacent companion seat.
- Adequate transfer capacity for elevator/lift access for the egress period to allow for the exit of spectators who use a wheelchair following the Ceremony in less than 15 minutes.
- The provision of alternative formats (e.g., audio and Braille upon request at the spectators info points) of any official programme.
- Concurrent translation in sign language and/or text on the videoboards during the protocol aspects, and other artistic elements, for people who are deaf or hard of hearing.
- A hearing augmentation system providing, in addition to higher volume, a live audio description of the various artistic elements that further enhances the experience for people with sensory limitations (hearing difficulties, blind and visually impaired).
- A stock of blankets and/or space heaters, particularly in accessible seating areas, to mitigate cold temperatures at outdoor ceremonies, particularly for people with mobility impairments and other circulatory issues.

## Paralympic considerations

The Paralympic Opening and Closing ceremonies present many challenges, given the large numbers of participants with a disability. The main areas of consideration include the transfer of the athletes to/from the Village to the stadium, the number of Paralympic Family members with a disability, the athletes' parade, the athletes' holding areas and the participation of performers with a disability.

### Transfer of athletes and team officials

All athletes entered to compete in the Paralympic Games and all team officials of the NPCs have the right to participate in the Opening and the Closing Ceremonies of the Paralympic Games. The OCOG allocates adequate resources (suitable types and adequate number of accessible vehicles - preferably low-floor buses) for the transfer of approximately 1,800 athletes who use a wheelchair for the Summer Games and approximately 400 athletes who use a wheelchair for the Winter Games.

The drop-off and pick-up zones in the Paralympic Village(s) and the Ceremony venue (or other ceremonies' sites) are suitable for independent, safe and quick loading and

unloading of the athletes. This may require the use of temporary kerbs for the low-floor buses to allow efficient and effective egress and ingress.

The flow from the drop-off zone to the holding areas, as well as the flow from the stadium to the pick-up zone, are accessible and wide and long enough to accommodate the amount of the athletes with a disability. For specific information about accessible pathways, see Section 4.2 Pathways.

The provisions of vehicles, loading zones and paths allows all athletes to depart for the Paralympic Village(s) within 75 minutes (Summer Games) or 45 minutes (Winter Games) after the end of the Closing Ceremony.

### **Amount of Paralympic Family members with a disability**

Adequate numbers of accessible seating is secured in the accredited seating area for the Paralympic Family. Although the exact need is determined after accreditation applications processing, the OCOG plans for 120 spots (Summer Games) or 70 spots (Winter Games).

There are independent, safe and quick flows between the Paralympic Family Lounge (and a reception area, if existing) and the Paralympic Family seating.

An operational plan for elevator/lift access allows for the timely exit of wheelchair users following the Ceremony in less than 15 minutes.

A key consideration is there is no segregation among members of the same subgroup of the Paralympic Family based on their physical condition; e.g., whether they use a wheelchair or not.

### **Athletes' parade**

The flow from the holding area to the main stadium, and the ingress and egress from the arena or the stage, is accessible according to standards and operational needs.

All the athletes of each NPC delegation parade together. After the end of the parade, the NPC delegation members remain together. Should a separation between ambulant and wheelchair users be required, this is kept to a minimum and is invisible to the audience to the greatest extent possible.

To allow athletes to use a toilet during the ceremonies, additional temporary, accessible toilets are provided at the staging area and also close to the arena.

Where live audio description services are provided, receivers are made available to athletes with visual impairments (distributed through the NPCs) for use during the Ceremonies.

### **Performers with a disability**

It is desired (and common practice) that performers with a disability are included in the artistic groups participating in the Opening and/or Closing Ceremony. Therefore, accessible flows are needed for at least a part of the performers' holding areas and to/from the necessary stages and settings.

## Spectators with a disability

For the Paralympic Ceremonies, the OCOG provides a certain number of spectator accessible and companion seats. For specific information on accessible seating, see Section 3.6 Venue accessible seating. The design and transfer capacity for elevator/lift access for the egress period has in mind the needs of the Paralympic Ceremony.

### **7.5.7 CEREMONIES (VICTORY CEREMONIES AND SPORT PRESENTATION)**

Victory Ceremonies are a core element of Olympic and Paralympic tradition and protocol. The ceremonies teams of an OCOG are responsible for creating Olympic and Paralympic Victory Ceremonies that celebrate the greatest athletic achievements.

Sport Presentation creates the atmospherics for sports competitions. By providing the announcers, music, videos, and live cultural performances, it enlivens the venues and competition and educates spectators. Operationally, Sport Presentation also manages the flow of sport competition sessions. Under the direction of international federations and the OCOG Sport Functional Area, Sport Presentation scripts, produces and directs the competition and spectator experience.

#### **Accessibility provisions**

For the spectators to enjoy the experience of the Games, it is important they have access to what Sport Presentation has to offer. The OCOG provides a hearing augmentation system in public areas of the competition venues so that people who are deaf or have a hearing impairment can equally enjoy the event and its presentation and participate in all activities. The system is available for seats in all ticket price categories.

Any scoreboard or video screen capable of displaying public announcements is also capable of supplementing the public address system.

#### **Paralympic considerations**

The design of the podiums for the Paralympic Victory Ceremonies have a ramp of no more than **1:12 (8.33%)** gradient for all Paralympic sports with athletes who use a wheelchair for competition or daily living.

To allow for medal presenters who are wheelchair users to efficiently and safely perform their duty, the height of the podium for the 1st place does not exceed **300mm**.

The athletes' staging area is in an area within the venue that allows access for both athletes and medal presenters of any functional ability.

The route from athletes' staging area to the podium is accessible. This is particularly important for the skiing sports of Paralympic Winter Games, where ground gradient may be a challenge.

A Paralympic-specific script for announcers is required for each Paralympic sport. Announcers should be trained about this script and in the proper terminology used for Paralympic sports and when referring to athletes with a disability.

The requirements for Paralympic Victory Ceremony set-up and protocol including accessibility considerations are specified in the HCC - Operational Requirements.

## **7.5.8 CITY OPERATIONS**

City Operations is about the city working as a pleasant and enjoyable place, as successful Games are measured not only by the performance of venues and events but also by the qualities of the broader urban domain, including atmosphere, ambience, access and easy movement, security and amenities.

Effective City Operations enables Olympic and Paralympic stakeholders and the public to move around reasonably freely, including travelling to and from the venues. It seeks to involve the general public, beyond those attending the events, in the spirit and excitement generated by the Games.

Integrated operations of accommodation sites, vehicle movements, pedestrian movements and gathering places and car parking/deliveries are fundamental.

The City Operations function of the OCOG has the task to work together with city and other public authorities, make them aware of the Games-related requirements that fall under the responsibility of the OCOG, and transfer the plans of these authorities to the suitable OCOG functions.

The requirements for the OCOG to cooperate with the host city to provide an accessibility awareness programme and accessibility enhancements are specified in the HCC - Operational Requirements.

### **Accessibility provisions**

The notion of universal design is considered from the very early stages of the bid process, through the OCOG's creation and to the last-moment fitting of overlays as regards to the host city's preparation for the Games. This way the widest range of host city residents and visitors are able to fully engage in the context of Games activities and enjoy the Games.

The host city creates a network of accessible routes to key city attractions. For specific information of accessible and inclusive host city elements, refer to Chapter 6 The city.

The co-ordination between the OCOG and city/public authorities is critical for accessible and inclusive city operations. For Games spectators, the end-to-end experience (from their home to their venue seat) ensures accessible routes and transportation options exist for their entire journey.

### **Paralympic considerations**

Accessibility provisions for the host city apply for both the Olympic and Paralympic Games. Additional aspects for the operations for the Paralympic Games are:

- Enhanced accessible public transport (e.g., low-floor buses) from the main competition venues and the Paralympic Village to the city centre, due to the increased demand of participating athletes.
- Adequate signage and assistance for access to dedicated parking spaces next to the venues for persons with a disability.
- Accessible pathways from the drop-off/pick-up points for other sports' spectating athletes at the competition venues.
- Enhanced accessible spots in city entertainment and/or live sites set up for the Paralympic Games, due to a higher number of athletes and Paralympic Family members who have a disability.
- Provision of customised solutions to address the issue of inaccessible 'first mile' obstacles that exist in connecting resident's home to closest accessible transport station.

## **7.5.9 CLEANING AND WASTE (AND SNOW REMOVAL)**

Cleaning and Waste is responsible for the collection, removal and disposal of all waste types generated from all areas throughout all Olympic and Paralympic competition and non-competition venues.

### **Accessibility provisions**

The tenders for appointment of the contractors contain strict requirements about elements such as size, colour and signage of the waste bins so that they:

- Are visible by those with visual limitations;
- Do not obstruct or limit pathways to less than accessible standards; and
- Are detectable by people using sticks.

The height of the waste bins is set at a maximum 1,200mm to allow people using a wheelchair to discard their disposals.

The OCOG FA venue manager ensures the above are set up and positioned correctly before the Games and stay like that during the Games.

Additional accessible toilets are used in some instances and it is critical to ensure they have an appropriate level of cleaning to ensure hygiene levels are maintained.

### **Paralympic considerations**

The OCOG FA venue manager reassesses the position and look of waste bins, especially in areas for athletes and Paralympic Family, in view of their increased usage by larger numbers of people with a disability.

Snow removal during the Paralympic Winter Games is an additional consideration to ensure that athletes with mobility impairment continue to have the ability to navigate spaces unhindered, especially around the Village, transport load zones and venue entrances/exits.

## **7.5.10 COMMUNICATIONS**

Communications creates and maintains the best image possible of the Olympic and Paralympic Games and Organising Committee's performance at all stages of the project through proactive campaigning across the target audiences. It aims to engage and inspire the population of the host city, host country and the world. The Functional Area provides information and timely responses to the media and the public in general, as the majority of people do not experience the Olympic and the Paralympic Games in a physical sense, but rather they perceive them as consumers of various forms of media.

Through Communications, the OCOG actively attempts to communicate institutional values in a consistent manner throughout the event, thus enhancing awareness for and branding of the Games. Also, it aims to address any adverse publicity occurring from preconceptions, expectations or incidents before, during and after the Games.

A key task of the Communications FA is to assist media representatives in their efforts to run the stories behind and around the performances, in a way that reflects the values of the OCOG, the IOC and the IPC.

### **Accessibility provisions**

As the messages of the OCOG strive to reach the broadest audiences, media representatives or interested individuals who have sensory limitations have access to these messages in all forms they may take. Communications also takes into consideration the changing nature of technology as its communication means and how to consider accessibility as an integral component. The OCOG provides various means of communication through:

- Publications in alternative formats.
- Press conferences with interpretation in sign language.

- Media workshops using resources such as accessible slide packs, alternative formats of material, sign language interpretation, and subtitles in video commenting.
- Website with built-in accessibility provisions following the W3C guidelines.
- ONS/PNS (availability in alternative formats).
- INFO system with built-in accessibility provisions.

### **Paralympic considerations**

Although the same principles apply for the Paralympic Games, two elements present a difference in the scope of accessible means of communications:

- As the local and global audiences identify the Paralympic Games as the elite competition for athletes with a disability, it becomes an expectation that any means of communication will fulfil the strictest accessibility standards. Adherence to this expectation becomes essential for the OCOG.
- The percentage of media with a disability attending the Paralympic Games is higher than during the Olympics; the same applies for the general public. As a result, OCOGs proactively plan for increased availability of resources able to produce publications and other data in alternative formats to meet the expected demand.

## **7.5.11 DOPING CONTROL**

Doping Control plans and manages the material and human resources to implement a comprehensive doping control programme under the jurisdiction of the IOC and the IPC (respectively for the Olympic and the Paralympic Games) and in accordance with the Anti-Doping Rules and in conformity with the World Anti-Doping Code and its accompanying international standards.

Doping Control is responsible for developing a test distribution plan, outlining the number, selection methodology, and timing (in competition; out-of-competition (OOC) and type of sample required for each sport, e.g., urine, blood, breath). This plan determines the location and size of each doping control station and the workforce required to be recruited and trained.

### **Accessibility provisions**

Accessibility provisions apply in the Olympic/Paralympic Village doping control station, as well as the doping control stations of venues that host a Paralympic sport where athletes use a wheelchair for competition or for daily living or have other mobility or visual limitations.

In those venues access to the area is accessible with a door width of minimum **1,000mm**. Using an accessible toilet for all doping control stations in the Olympic and Paralympic venues allows easier access by supervisory staff and a carer or a

companion if the athlete is less than 18 years of age, as well as assisting accessibility for athletes who use wheelchairs.

The OCOG provides at least one fully accessible toilet in the doping control station. For specific information regarding accessible design for washrooms, see Section 5.3 Toilet compartment and cubicles.

### **Paralympic considerations**

Best practices recommend that doping control stations in competition venues are already accessible prior to the Olympic Games. However, if for any reason this is not feasible, necessary adaptations and overlays are installed during transition, based on a tight schedule, as the stations are ready as soon as the Paralympic Village opens and the start of training in a competition venue.

Doping control information materials are available in alternative formats, such as Braille, large print, and be provided upon request.

## **7.5.12 EVENT SERVICES**

Event (or Spectator) Services provides crowd management, customer service and overall venue operational support at all competition and, if so decided, selected non-competition venues such as the Main Press Centre, IBC and Sponsor Hospitality. It is the largest and most visible part of the workforce of the Games.

Operational activities of Event Services include:

- **Pedestrian flow and crowd management** - assisting spectators to and from transportation terminals, on approaches to venue entrances, security screening areas, queuing areas, venue concourses, seating and standing areas.
- **Ticket taking** - collecting, reading, recognising, validating and ripping different tickets for each session.
- **Ushering** - providing assistance to spectators in the venue's seating and viewing areas.
- **Access monitoring** - implementing the accreditation scheme during 'on' hours.
- **Public information and Olympic/Paralympic experience** - improving the Games experience by ensuring spectators are properly informed before and during their visit to venues. Tasks include spectator guide, on-venue public address announcements and video-board messaging, public information booth operations, and spectator lost and found operations.

### **Accessibility provisions**

Supporting accessible operations is a fundamental task for Event Services. It provides assistance to persons with a disability (e.g., mobility, sight, hearing) as part of the OCOG's overall accessibility plan. Typically, the Event Services role is restricted to pedestrian movement and seating assistance within the venue perimeter.



To perform this task, training about servicing customers with a disability is provided in a more enhanced level than the typical disability awareness training for the rest of the workforce. This training may involve experts, lectures and hands-on experience, especially for the team leaders.

Other accessibility considerations include:

- Making spectator information materials available in alternative formats, such as Braille, large print, upon request and online.
- Distributing assistive hearing devices to spectators.
- Providing Games Mobility services, such as wheelchairs and electric scooters loan and storage. Refer to Section 7.6 Mobility Services (or Games Mobility) for further information.
- Assisting with elevator access and use, and facilitating priority loading for wheelchair users as required.
- Monitoring and maintaining accessible pathways for spectators.

As the largest part of the workforce, Event Services provides opportunity for active participation of persons with a disability as volunteers. In each venue all suitable service provision spots should be identified, allowing for an enjoyable and equitable experience for staff with a disability as for the rest of the staff of Event Services.

### **Paralympic considerations**

All provisions described equally apply for the Paralympic Games.

If a multisession 'Day Ticket' scheme applies for the Paralympic Games, Event Services ensures an accessible path of travel between the various individual venues within a complex. For specific information regarding accessible pathways, see Chapter 4 All accessible routes.

## **7.5.13 FOOD AND BEVERAGE SERVICES**

The Food and Beverage function is responsible for procuring and managing the provision of food and beverage services for all Games stakeholders at competition and non-competition venues for the Olympic and Paralympic Games. It is responsible for:

- The main (and secondary if existing) dining area(s) in the Olympic and Paralympic Villages.
- The provision of food and beverages in the lounges of the competition venues (for athletes, technical officials, Olympic/Paralympic Family, media).
- The operation of food concessions for spectators at the competition venues.
- The provision of snacks, refreshments, etc., at the training sites for athletes use.
- The provision of food and beverages for the workforce of the Games.

Contractors deliver the majority of these services. The management of the functional area is responsible for setting the requirements and conducting the respective tenders and then overseeing the operations at Games-time.

### Accessibility provisions

Catering ensures that all necessary accessibility provisions are clearly included and specified in the tender documents. Compliance with these specifications is part of the assessment criteria of the various tenders; non-compliance is a factor for rejection.

The OCOG provides accessible dining areas for the Olympic and Paralympic Family, media, workforce by ensuring:

- The corridors among tables are at least **1,500mm** wide.
- Allocation of the various beverages, deserts, etc., are in vertical (rather than horizontal) configuration.
- Table heights of **850mm** with **750mm** knee clearance.
- Cutlery items located at a height up to **1,200mm**.
- Signage and menus are displayed by signs with high-contrast colours.
- Serving counters have at least a section that is up to **850mm** high, **1,000mm** in length.
- No step or other obstacle prevents access in front of, or in queuing area of, the serving area.

For additional information on accessible considerations with regards to food and beverage, see Section 6.5.2 Retail and food and beverage outlets.

### Paralympic considerations

All dining areas have accessibility features already installed before the Olympic Games. However, the scope of accessibility needs for the Paralympic Games (especially for the athletes) requires additional consideration and provisions:

- In the Village(s) dining areas, the width of doors for the athletes and the workforce is at a minimum **2,000mm**, allowing for the flow of wheelchair users crossing.
- The corridors among tables are at least **1,800mm** wide.
- Serving counters are not greater than **850mm** high with clearance of **750mm** underneath all counters.
- 25% of each group of chairs is removed to allow seating for wheelchair users.
- Cafeteria trays are made available to make transporting multiple items easier for people using a wheelchair.
- The same considerations are made in the lounges at the venues, along with providing a mix of both low and high tables.

The requirement for Paralympic Games dining areas and lounge to be fully accessible is specified in HCC - Operational Requirements.

### **7.5.14 LICENSING - MERCHANDISING - RETAIL OPERATIONS**

Licensing oversees the Games-time merchandise sales and operations at retail points of sale located within competition venues, the Villages, the Olympic Superstore(s), selected airports and e-commerce web sites. The concessionaires appointed by the OCOG typically manage the outlets.

#### **Accessibility provisions**

Merchandising outlets' service counters are at a height of **850mm** with **750mm** of knee clearance underneath. If this not possible or practical, at least **1,000mm** of counter space is accessible. For specific information to accessible service counters, see Section 3.5.2 Table and counters.

No step or other obstacle prevents access in front, or in the queuing area of, the merchandising outlets.

In self-service outlets or stores, items are allocated vertically rather than horizontally, in order to allow pick up from customers of any height.

It is recommended that licensees create a range of products for minority user groups, such as the left-handed. Whenever possible, items can be used by persons who use only one hand.

#### **Paralympic considerations**

Merchandise items with the Paralympic trademarks are usable by the widest range of users.

All accessibility provisions as above for the retail stores equally apply for the Paralympic Games.

### **7.5.15 MEDICAL SERVICES**

Medical Services is responsible for co-ordinating all aspects of medical/health services measures for athletes, team and technical/Games officials, Olympic/Paralympic Families, and other accredited persons for all medical conditions occurring during their stay in the Games, as well as for spectators during their stay in a venue.

The service is designed to provide first aid and an advanced first response in all competition and training sites and most non-competition venues. In addition, a comprehensive range of medical specialties are provided within the Polyclinic of the Olympic/Paralympic Village. This service is linked to a designated Games hospital network by a dedicated ambulance transport service that supports the venue-based medical teams.

## Accessibility provisions

All venue-based medical facilities (usually one dedicated to athletes and one for Olympic/Paralympic Family and spectators) are accessible. Refer to the Technical sections of the Guide (Chapter 3-6) for specific information on accessible environments. Special consideration provides for the existence of an accessible pathway for the respective stakeholder groups. At least one fully accessible toilet is provided in each medical station of a venue. In the Winter Games context, medical staff are trained in techniques for safely removing athletes from their equipment, such as sit skis and sleds, relevant to each sport.

The Village Polyclinic is fully accessible. All elements of an accessible indoor facility are implemented, such as entry and exit, pathways and corridors, door widths, washrooms, lifts (if existing), and service counters. Best practice is for all service areas of the Village Polyclinic to be on the same floor, to facilitate easy access for all.

The OCOG issues and distributes to the Olympic hospital network guidelines on accessibility provisions in view of the upcoming Games.

## Paralympic considerations

Athlete medical areas in competition and training venues that host Paralympic sports with athletes who use a wheelchair for competition or daily living have doors with a minimum width of **1,000mm**.

At least one medical bench in those areas is adjustable in height, in order to allow for athletes with a more severe impairment to access it.

## 7.5.16 NOC/NPC SERVICES

NOC/NPC Services is the official channel of communication between the OCOG and the National Olympic Committees (NOCs) and the National Paralympic Committees (NPCs) for the Olympic and Paralympic Games respectively.

It aims to create a positive and professional communication platform for the NOCs/NPCs and the OCOG in order to facilitate a consistent and correct level of service to all. Among other tasks, NOC/NPC Relations is responsible for:

- Issues resolution in the pre-Games period.
- Organisation of the Chefs Seminars and production of the Chefs de Mission Guides.
- Management of NOC/NPC visits to the host country and the OCOG.
- Delegation registration meetings.
- Allocation and management of NOC/NPC assistants.
- Management of the NOC/NPC Services Centre(s) in the Olympic/Paralympic Village(s).
- Management and follow-up of the NOC/NPC Chefs de Mission meetings.

### **Accessibility provisions**

To minimise work during the transition period, all areas of Games-time operations that are managed by the NOC/NPC Services are designed and built as accessible or adaptable.

### **Paralympic considerations**

Upon request, the Chefs de Mission Guides and other publications addressed to the NPCs are available in alternative formats for those with a visual impairment.

The location and the reference material of the Chefs de Mission Seminar is available in alternative formats for participants with a visual impairment upon request.

Delegation registration meetings, along with all areas of the NPC Services centre and the Chefs Meeting Hall, meet accessibility standards. Refer to Section 7.4.2 Olympic AND Paralympic Villages for specific information on accessible environments within the Village.

In order to perform their role, NPC assistants receive training about servicing customers with an impairment at a level greater than the typical disability awareness training for the rest of the workforce. This training may involve experts, lectures and hands-on experience.

## **7.5.17 OLYMPIC AND PARALYMPIC FAMILY AND DIGNITARY SERVICES**

The Olympic and Paralympic Family and Dignitary Services Functional Area is responsible for the development and execution of protocol and other services for the Olympic and Paralympic Family, and for the management of the Dignitary programmes.

Among other tasks, the FA is responsible for:

- Venue protocol, including airport protocol; protocol assistants programme; meetings and guest programmes; and Olympic/Paralympic Family Hotels management.
- Protocol policy and implementation, including flag and anthem programme; Olympic/Paralympic Village protocol; dignitary programme (sovereigns, heads of state and government and ministers responsible for sport)

### **Accessibility provisions**

During the operational planning process, the FA represents the members of Olympic and Paralympic Families. The OCOG provides an accessible pathway connecting the following venue areas: T1/T2/T3 drop-off, Olympic/Paralympic Family Lounge and Accredited Seating. For specific information on accessible pathways, see Section 4.2 Pathways.

The Olympic/Paralympic Family Lounge has an accessible entry. The service counters are at a height of **850mm**, with **750mm** of knee clearance underneath, for at least **1,000mm**, and at least one toilet is accessible.

At each venue, there is adequate accessible seating for the Olympic Family and Paralympic Family according to the specified amount by the IOC and IPC respectively.

For specific information regarding the Olympic/Paralympic Family Hotel(s), refer to Section 6.6 Hotel and Section 7.5.1 Accommodation.

### **Paralympic considerations**

The number of members of the Paralympic Family who require accessible amenities and services is significantly higher than the corresponding amount of the Olympic Family. Additional requirements compared to those recorded above are:

- In the accredited seating area for the Paralympic Family, the number of required accessible seating spots varies from venue to venue depending on the sport, and is provided by the IPC for each Games' edition.
- The Presidential Box for the Opening and Closing Ceremonies is accessible in a way that the first row of seating (to be used by the head of state of the host country and the President of the IPC) is accessible. The other rows of this VIP seating are located above this first row.
- Both low and high tables are provided in the Paralympic Family Lounge.
- Accessible pathways connect the seating area and the lounge to the staging area for the Victory Ceremonies.
- At least two accessible toilets exist in the Paralympic Family Lounge for Para athletics, Wheelchair basketball and Para swimming.
- Where assistive hearing devices are provided, or live audio description services offered, receivers are available to Paralympic Family members.
- The Paralympic Family Guide should be made available in alternative formats, upon request.
- In order to perform their role, protocol assistants assigned to members of the Paralympic Family who have a disability receive training about servicing customers with the particular impairment, in a level greater than the typical disability awareness training for the rest of the workforce. This training may involve experts, lectures and hands-on experience

Overall, when considering adequacy of provisions for the Paralympic Family, realistic estimation is required. There is often an over-allocation of seating and accessible toilets in one instance and in other instances not enough capacity of lifts to ensure efficient vertical movement. Communication with the IPC and the NPCs will assist the planning process.

## **7.5.18 PEOPLE MANAGEMENT**

People Management is responsible for the planning, delivery, retention and care of the paid staff, volunteers, and contractors necessary to stage the Games.

The scope of work of People Management is huge, as years of efforts are needed in quantifying, identifying, recruiting, training, scheduling, accrediting, uniforming, integrating, managing, and sustaining a workforce approaching 150,000 in the Summer Games and 50,000 in the Winter Games.

**Games-time responsibilities of People Management include:**

- Uniform distribution (centralised)
- Training support (general and venue training)
- Workforce check-in
- Break/meal management
- Scheduling support
- Workforce relations and recognition
- Workforce communications
- Incident reporting

### **Accessibility provisions**

The OCOG ensures that people with a disability have equitable access to work as paid and/or volunteer staff at the Games as any other member of the local or international workforce. In order to achieve that, the OCOG considers the following aspects:

### **Workforce recruitment**

- Undertaking initiatives to encourage and attract applications from persons who have a disability.
- Setting specific and measurable targets for the percentage of persons with a disability among each type of workforce, making managers accountable to achieve the targets, conducting periodic reviews to assess progress, and undertaking corrective actions where needed.
- Ensuring recruitment policies and practices do not discriminate against applicants with a disability, but rather encourage them to apply (e.g. guarantee an interview if a person with a disability meets required qualifications for the job).
- Identifying the few job positions (especially at Games-time) for which a job offer for a person with limitations in mobility or sensory capacity is not recommended and make clear that ALL other job positions are equally available to all people with the necessary skills, regardless of disability.
- Working with local organisations to identify and recruit individuals with a disability.
- Considering a targeted recruitment of Paralympians for job positions related to their profile and experience which has successfully been used in past Games.

## **Workforce policies**

Establish policies that enable easier access to work for persons with higher support needs. Such policies may be:

- Secure 3-4 parking spots in the operational parking of each venue for members of the workforce with a disability, regardless of their job title and function.
- Establish flexible and/or suitable working hours, check-in and check-out processes in cases where public transport or venue configuration limitations prevent or make it extremely difficult to access the venue on early or late hours or in certain areas of the venues.

## **Workforce areas**

During operational planning the OCOG ensures that all workforce areas of all venues are accessible. These areas include:

- Workforce check-in and check-out
- Workforce lounge
- Briefing area(s) if dedicated
- Workforce toilets, including gender-neutral accessible toilets

Refer to the Technical sections of the Guide (Chapter 3-6), for specific information on accessible environments.

The Uniform Distribution and Accreditation Centre (UAC) should fulfil all accessibility criteria as described in this Guide. Essential aspects of such provisions include entry and exit, waiting areas, width of corridors, service counters, and dressing rooms. For specific information regarding the UAC, see Section 7.4.3.3 Accreditation Centres.

## **Workforce training**

Equitable access to training material is available for persons with a disability who are members of the workforce. For this reason, the OCOG provides the generic training material upon request in alternative formats (Braille, large print, audio etc.).

In addition, People Management has a process in place for the other FAs or venue teams to produce job specific and/or venue training material in alternative formats.

All workforce members receive disability and accessibility awareness training. For specific information on disability awareness training, see Section 7.3 Staff Awareness and Training.

## **Paralympic considerations**

As the Games workforce is considered one for both Olympic and Paralympic Games, all the above guidelines equally apply for the Paralympic Games. However, it is expected that higher numbers of volunteer workforce who have a disability will offer



their services for the Paralympics. Thus, more provisions are made, such as allocating more parking spots for workforce members with mobility impairments, at the venues during the Paralympic Games.

Furthermore, as a result of the increased number of persons with an impairment among the stakeholder groups of the Paralympic Games, the OCOG schedules a more focused disability awareness training for certain groups among the volunteer and contractor workforce that may include the operational parameters of the Paralympic sport competitions and venues.

### **7.5.19 PRESS OPERATIONS**

Press Operations co-ordinates the facilities and services needed by the written and photographic press accredited to cover the Games. Among other tasks the FA is responsible for:

- Planning, staffing and operating the Main Press Centre (MPC).
- Operating the Venue Media Centres in the competition venues.
- Assisting OBS with the delivery of the Olympic Information Service (OIS) to provide the editorial content of Info system.
- Planning and overseeing key media services such as accreditation, accommodation, press rate card and transport.

#### **Accessibility provisions**

There are persons with a disability among the written and photographic press who cover the Olympic and Paralympic Games. Therefore a) press facilities comply with accessibility standards and b) equitable media services are provided for media representatives who have a disability.

During the operational period, an accessible pathway connects the following venue areas: Media Drop-Off, Media Work Areas, Media Lounge, Press Seating, Press Conference Room, Mixed Zone and Photo Positions. For specific information on accessible pathways, lifts, staircases and others used by the media, see Section 4.2 Pathways.

The Main Press Centre is an accessible facility. For specific information on an accessible Main Press Centre, see Section 7.4.3.1 Main Press Centre (MPC).

The media areas in the venues have accessible entries. The height of some (if not all) of the tables in the working stations have knee clearance of **750mm** underneath; the service counters are at a height of **850mm**, with **750mm** of knee clearance, above the floor for at least **1,000mm**; and accessible toilets need to exist next to the lounge according to standards.

The press tribunes at each venue include three to five accessible spaces, with full-service provision.

The OCOG identifies via the press accreditation process which journalists and photographers use a wheelchair. For those individuals, Press Operations plan for suitable services, such as:

- Accessible transport in a customized basis.
- Accessible accommodation, in selected accommodation sites, which offer a variety of price selection.

The Info system should comply with accessibility standards for web-based applications.

### **Paralympic considerations**

For the Paralympic Games the number of accredited media who have a disability may increase compared to the Olympic Games. Therefore, resources and bookings are adjusted.

For the Paralympic Winter Games where an MPC is not required, services may be provided at one Venue Media Centre (VMC) or spread over several VMCs. The OCOG ensures two accessible press conference rooms.

In venues where there is a Paralympic sport with athletes who use a wheelchair for competition or daily living, the Mixed Zone adapts as follows:

- The width of routes are at least **2,200mm** to allow movement of athletes while a fellow athlete is being interviewed.
- The barricades for separation between media and athletes are no more than **600mm** high, to allow for interviewing at same level for both athletes or press who are wheelchair users.
- Considerations are made in sports where athletes stay in their sports equipment (such as road cycling, cross country skiing, etc) that an alternate surface is used for the mixed zone. Alternatively, an operational solution is created to allow athletes to return to the locker rooms to change from their sport equipment to wheelchairs and prosthetics before going through the mixed zone (such as para ice hockey during PyeongChang 2018).

The accessible seating requirements for press during the Paralympic Games may be far above three. The exact minimum requirements of accessible press tribune position per Paralympic Sport are determined in collaboration with the IPC for every edition of the Games.

The requirements for media services, including accessibility considerations, are specified in the HCC – Operational Requirements.

## **7.5.20 RATE CARD**

Rate Card works closely with Finance, Planning, Procurement, Technology and Logistics to establish a solid Rate Card that will meet the needs of its key customers. These customers include the Olympic/Paralympic Family, NOC/NPC delegations, press agencies, broadcasters and other Olympic/Paralympic partners.

The Rate Card team establishes the needs of its customers, sourcing rate card items and market rates, and designing a user-friendly ordering system and an integrated delivery and recovery system with Logistics to all Competition and Non-Competition venues.

### **Accessibility provisions**

Rate Card material is available in alternative formats, upon request from a customer. If Rate Card is in a web-based application, it fulfils the respective accessibility requirements.

### **Paralympic considerations**

Rate Card investigates items for specific needs related to accessibility, especially for the Paralympic Games. In past Games, items such as electric scooters and mobility aids were requested and offered via the Rate Card.

## **7.5.21 RISK MANAGEMENT**

Risk Management Functional Area has two core responsibilities:

- To identify and address potential risks to ensure the highest standards of safety are maintained at all times for all those involved in the Games, including spectators, Olympic/Paralympic Family, broadcasters, contractors, volunteers and staff.
- To manage the insurance aspects of any incidents, including injury, death, property loss or damage, as well as other insurable events, such as interruptions to competition or other causes of lost revenue.

### **Accessibility provisions**

Risk Management in every venue ensures that all areas used (even potentially) by people using a wheelchair have an immediate accessible pathway to a secure assembly area. Evacuation plans are developed with this parameter in mind.

In the case of already existing facilities that do not allow for the development of such solution:

- Usage is avoided if adequate alternatives exist, or
- Suitable areas are identified, providing the maximum duration of safety, where people with a mobility impairment may stay until help is provided.

Visual emergency signals are available in the spectators' area. Videoboards and monitors in the venue also communicate emergency messages to stakeholder groups for people with hearing limitations. Staff assigned with evacuation responsibility are fully aware of this area and direct people accordingly. Evacuation for people with mobility and sensory impairments is tested by the venue team in the pre-Games phase.

For specific information regarding evacuation, see Section 3.7 Emergency provisions and Section 4.10 Evacuation routes.

### **Paralympic considerations**

The high number of people with a mobility impairment in the athletes' area, as well as the Paralympic Family areas, requires special attention. In these cases, provisions that are considered adequate in other circumstances are not enough. The OCOG organises a detailed operational plan, in order to identify optimum solutions.

## **7.5.22 SECURITY**

Security's role is to ensure the Games are conducted in an atmosphere of safety, free from the risk of disruption by hostile elements. Security forces are able to counter the threat, or consequences, of terrorist or anarchist acts of violence; deal with outbreaks of public disorder and other crimes intended to disrupt the Games; and manage the consequences of any natural disaster threatening the population as a whole.

One of the most visible activities of Security at Games-time is the control of every individual and item carried in a venue via magnetometers and visual checking, without exceptions.

### **Accessibility provisions**

Persons with a disability are equally subject to security screening as any other stakeholder of the Games. As measures that apply to other populations are not effective in cases such as wheelchair users or people who use a prosthetic limb, an adapted control protocol is required. For this reason, special training is provided to security personnel (police, volunteers) in order to perform this task with both dignity (for the customer) and efficiency (for security).

In every venue entry where there are magnetometers, an operational gate without a magnetometer provides a width of **1,000mm** for entry of wheelchair users. Security control in these gates is performed by portable magnetometers. For specific information on accessible entrance gates, see Section 3.2.7 Gates and turnstiles.

The protocol for vehicles carrying people with a disability going through a vehicle check point allows a wheelchair user to stay in the car and be scanned with a hand-

held magnetometer. Other occupants of the vehicle are scanned as per standard operation.

If scanning ports for accreditation cards exist, they are lowered to allow wheelchair users, who have such cards hanging around their neck, to easily scan as would anyone one else.

### **Paralympic considerations**

The level of security for the Paralympic Games is determined after a threat assessment study made from the security forces of the host country. The provisions specified above apply for the Paralympic Games.

Due to the composition of the residents of the Paralympic Games (up to 1,800 athletes may use a wheelchair), the operational accessible gates in every village entry is doubled, compared to those existing for the Olympic Games.

## **7.5.23 SPORT**

Sport is the central focus of the Games. The priority for all Functional Areas is to provide the necessary support for the athletes and the sports competitions at the Olympic and Paralympic Games. Sport is a key function within the venue team and coordinates training and other support services; e.g., Sports Equipment, Sports Publications, Competition Schedule, Technical/Games Officials and Sport Volunteers.

### **Accessibility provisions**

The Sport FA makes every effort that planning for sport areas considers Paralympic competition requirements from the early phases, in order to minimise or even eliminate transition needs. For all competition venues, accessible considerations are further explained in Section 7.4.1 Competition Venues.

### **Paralympic considerations**

During the entire operational planning process, Sport represents key stakeholder groups of the Paralympic Games, such as the athletes, team officials, technical officials, and the IFs.

In the competition venues, an accessible pathway connects the following venue areas: Athletes Drop-Off, Locker Rooms, Warm-Up Areas, Field of Play, Mixed Zone, Doping Control, Victory Ceremony, Press Conference, Athletes Lounge and Athletes Seating. Physical elements, such as pathways, lifts and staircases, need to fulfil accessibility standards. For specific information regarding accessible routes, see Section 4.2 Pathways.

Other considerations include:

- The accredited seating area dedicated to athletes and team officials is a significant challenge, as a large number of accessible spots are provided. The number of required spots varies from venue to venue, depending on the sport. The exact minimum requirements per sport is set by the IPC for each edition of the Games.
- Both low and high tables are provided in the Athletes' Lounge in venues with sports that include athletes who use a wheelchair for competition or daily living.
- Accessible pathways are identified from the seating area and the lounge to the athletes' staging area for the victory ceremonies.
- Sport publications addressed to the NPCs and the IFs are available in alternative formats, upon request.

More information on design standards and provisions for the sport areas of the Paralympic competition venues can be found in the Olympic Games Guide on Venues. These include provisions for accessible toilets, lounges, seating, dressing and locker rooms, field of play, warm-up areas, training sites, IF and Games officials work areas.

Sport provides, in co-operation with the IPC, information to the other OCOG Functional Areas regarding estimated numbers of athletes per sport and per type of impairment as of the qualification systems that apply for the Paralympic Games.

### **Mobility aid repair service**

A mobility aid repair service operates in the Paralympic Village and in several competition venues. Access to those areas is unobstructed by any physical barrier, including ground configuration. In the Paralympic Village, the internal transport system serves this facility. In the competition venues, the service is positioned within the athletes' preparation area.

## **7.5.24 TECHNOLOGY**

Technology at the OCOG level is typically comprised of five key building blocks:

### Technology Programme Management

- Responsible for Technology programme management processes, reporting, workforce planning and technology operational readiness planning; key interface with Finance, People Management, Planning and Coordination, and Information and Knowledge Management areas.

### Infrastructure and Telecommunications

- Responsible for technology infrastructure planning and delivery, primarily focused on telecommunications and AV; key interface with Venues and Infrastructure, Energy, and Broadcast Services areas, telecommunications partner(s), end-user equipment partner and AV partner.

### Information Technology

- Responsible for the planning, implementation and support of all GMS, OMS and corporate IT systems. Therefore, it has relationships with all OCOG areas requiring IT systems as well as the IT partner. A key interface is with the Communications area on digital media services.

### Venue Technology Management

- Responsible for technology venue planning, delivery and operations at all sites, considering the technical requirements set out by other Technology areas; key interface with Venues and Infrastructure, Venue Management, Energy, and Logistics areas and all technology partners and stakeholders at the venue level.

### Results Technology

- Responsible for delivering all venue results-related services and operations including T&S, OVR and ODS systems and ORIS/PRIS project management; key interface with the IT integration partner, T&S partner and the Sport, Press Operations and Broadcast Services areas.

## Accessibility provisions

Technology provides the solutions that enable access to information, improve the event experience and allow for communications. In co-operation with the appropriate OCOG FAs, Technology provides or assists in providing:

- Production of publications in alternative formats (audio, large print, etc.).
- Accessible telephone booths and telephones with typing capability.
- Websites and web applications fulfilling accessibility standards (INFO System, OCOG web site).
- Hearing augmentation systems.
- Live audio description services.
- Audio information at Spectator Info Points.
- Availability of printing in Braille language (upon request).
- Facilitation of software or hardware needs to allow effective work for OCOG staff with mobility or sensory limitations.

## Paralympic considerations

As the scope of accessible technology needs is significantly higher than during the Olympic Games (such as screen reading software for computers in the internet café), implementation of all the above accessibility provisions at the Paralympic Village - or at least the basic infrastructure for these provisions - is installed prior the opening of the Olympic Village. This minimises the scope of transition.

## 7.5.25 TICKETING

Ticketing is responsible for the sale and distribution of all tickets to Olympic and Paralympic events. Ticketing will affect the overall image of the Games, as it is the most tangible link between the Games and the public at large. Ticketing is one of the main outlets for the general public to obtain an Olympic and Paralympic experience. It is, therefore, essential that this functional area has a client service orientation.

### Accessibility provisions

Access to the Games and an equitable event experience is available for every individual who wishes to attend the Games. For this reason, Ticketing plans its processes and procedures so that this principle is observed for all. Therefore, Ticketing implements inclusive policies and practices that will allow this access. These are:

- In the pre-Games period, ensure that ticket applicants who have a disability can indicate their exact needs accurately via the ticket application documents and processes, in all phases.
- Ticket Guides are available upon request in alternative formats, for people with visual impairments.
- Any ticketing web site fulfils accessibility standards.
- Ticket box offices have at least one service counter at a height of **850mm** with knee clearance of **750mm**, above the floor, for at least **1,000mm** of counter. No step or other obstacle prevents access in front of or in the queuing area of the merchandising outlets. For specific information to accessible service counters, see Section 3.5.2 Table and counters.
- In co-operation with other FAs (Overlays, Venue Operations, etc.), Ticketing captures wheelchair accessible seating at an overall rate that is aligned with Section 3.6 Venue accessible seating. Companion seating is provided next to the accessible seating positions.
- Venue Ticketing Management identifies a number of enhanced amenity seats in addition to wheelchair positions. These are equitably distributed and located at the ends of rows and up or down as few steps as possible. These seats are used for the needs of people with a temporary injury, elderly, pregnant women or other beneficiaries of an accessible environment. Such seats are kept out of the sales system.
- Venue Ticketing Management is aware of the seats where a hearing augmentation system operates, in order to properly direct those who are deaf or have a hearing impairment.

As the FA with a leading role in the planning for accredited seating, Ticketing co-ordinates related FAs in accessible seating allocation for each accredited group.



Ticketing takes adequate measures to ensure there is no discrimination among ticket holders based on disability. In past Games, complaints that attracted adverse media included:

- Lack of a ticket booklet produced in alternative format.
- Accessible seating not provided across the whole range of ticket categories.
- Lack of a free ticket to a carer (not a companion) who was essential to assist a person with a disability with enhanced support needs who paid full price.

### **Paralympic considerations**

The spectator accessible seating requirements increase in competition venues for Paralympic sports with athletes who use a wheelchair for competition or daily living.

The demand in accessible seating in the accredited seating areas is much higher than in the Olympic Games, especially for the athletes, the team officials, Games officials and Paralympic Family.

The Paralympic Opening and Closing Ceremony is considered as a high demand event for accessible seating. For these events, accessible seating needs to be maximised.

For further detail on seating requirements during the Games, please refer to Table 7: Spectator accessible seating at the Olympic and Paralympic Games.

## **7.5.26 TORCH RELAY**

Torch Relay is responsible for the planning and implementation of the Olympic Torch Relay (domestic part) and for the Paralympic Torch Relay.

It aims to make the torch relay a tool that will enhance awareness and excitement about the Games, promote the Olympic/Paralympic values and engage the whole of the host country with the Games.

### **Accessibility provisions**

Torch Relay ensures that persons with a disability of any kind and level are equally eligible to participate in the torch relay as torchbearers. In order to do that, provisions are made in both the application/selection process and the operational period.

Considerations include:

- Applications are open to all citizens without discrimination of any kind. During selection and nomination, people with a disability are selected as torchbearers to demonstrate equal rights and integration of the society.
- Torchbearers have the opportunity to make any necessary modifications to the uniform prior to their segment, if so required due to physical condition.
- Some torchbearers require the assistance of a guide and/or assistant in order to participate.
- Route considerations for torchbearers with a disability include gradient (to allow a person in a wheelchair or other mobility difficulty to perform their duty independently and with dignity), as well as access to kerb cuts.
- Holding devices are created for torchbearers in a wheelchair so the torchbearer can independently push the wheelchair while carrying the torch.
- An accessible van is available throughout the journey of the flame, to facilitate distribution of torchbearers with a disability for their segment.

The OCOG provides an enhanced level of disability awareness training for Torch Relay staff to enhance the experience and ensure the most positive participation of people with impairments in the Relay.

### **Paralympic considerations**

The above provisions equally apply for the Paralympic Torch Relay. As the percentage of persons with a disability among the total of torchbearers will increase, adequate resources (e.g. holding devices, accessible vans) are made available.

## **7.5.27 TRANSPORT**

Transport is responsible for land transport planning and operations for the Olympic and the Paralympic Games. Its primary mission is to provide safe, efficient, reliable and on-time movement of all members of the Olympic and Paralympic Family (athletes, media, IOC/IPC, NOC/NPC, IF officials, sponsors, invited guests, staff, workforce and volunteers) during the Games period. This responsibility includes the transport of all the following stakeholder groups to and from all competition and non-competition venues, with different transport vehicles used for various stakeholder groups:

- Athletes and team officials (buses)
- Technical officials (vans and buses)
- Olympic/Paralympic Family (cars and vans - usually called T1, T2 and T3)
- Media (buses)
- Workforce (dedicated buses and public transport)

Transport of spectators to and from Olympic and Paralympic competition venues is an additional operation, as hundreds of thousands of spectators and accredited persons are transported every day of the Games, generating huge concentrations of traffic.

### **Accessibility provisions**

With the exception of athletes, all other stakeholder groups of the Olympic Games include people with a disability. For this reason, accessible transport is offered in all the 'systems' mentioned above.

However, since the demand for accessible transport is expected to be higher in all categories at the Paralympic Games, the Transport FA procures resources and make plans according to the higher demand of the Paralympic Games.

Accessible transport for spectators is mainly a responsibility of the respective public authorities. For such provisions, please refer to Section 6.2 Transportation. However, OCOG Transportation still liaises closely with public authorities in terms of accessible public transport and transfers information related to Games stakeholders.

It should be noted that low-floor buses are the main type of bus considered for both Olympic and Paralympic Games, as this type of bus is not only universally accessible, but also allows large numbers of passengers to get on and off of the bus efficiently and safely without negotiating steps.

## **Paralympic considerations**

The OCOG procures and organises adequate resources in order to provide effective accessible transportation to the stakeholders groups. For each one of these groups that means:

### **Athletes and team officials (buses)**

For individual sports where athletes use a wheelchair for competition or daily living may compete, all vehicles are accessible. From past Games experiences it is recognised that the use of low-floor buses is an excellent solution that allows flexibility and adequate capacity for Games-time operation. The number of buses required depends on the capacity for passengers in a wheelchair and the profile of the sport.

For team sports where athletes who use a wheelchair for competition or daily living may compete, accessible dedicated buses are allocated to each team. The number of buses allocated per team may be more than one, depending on the capacity of the bus type for passengers in a wheelchair.

In both cases, Transport and Sport co-operate in order to determine the actual demand, according to factors such as the training and competition schedules, the profile of the sport and data on participating athletes.

### **Games officials (vans and buses)**

Transport, in co-operation with the Sport FA, determines the number of Games officials that use a wheelchair and allocates resources accordingly. Although it is preferred that all transport vehicles are accessible, the OCOG may decide to allocate customised resources according to needs of stakeholders

## **Olympic/Paralympic Family**

For accredited individuals with T1 or T2 entitlements, a survey is required to determine whether an accessible car is required.

For accredited individuals with T3 entitlements a pool of accessible cars/vans is available, in a ratio of one for every three individuals who need such a vehicle. Data is captured via the accreditation system.

The requirement for accessible T3 transport services during the Paralympic Games is specified in HCC - Operational Requirement.

### **Media (buses)**

Ideally, all of the media transport system (typically called TM) is accessible. Alternatively, a car/van pool of dedicated accessible vehicles is arranged for those media representatives that use a wheelchair.

### **Workforce (dedicated buses and public transport)**

A total of 3-4 parking spots are made available in the operational parking of each venue for members of the workforce with a disability regardless of their job title and function. For venues not being adequately served by public transport for which OCOG establishes a workforce transport system, part of the transport solution is accessible.

At the venue level, transport stations, load zones, parking areas and signage is accessible and the OCOG provides provision for easy loading and unloading of passengers who use a wheelchair.

Additional information related to transport services can be found in Section 6.3 Parking and Section 4.8 Transport load zone.

## **7.5.28 VENUE MANAGEMENT**

Venue Management leads the venue-level integration of internal OCOG functions and all external party involvement at all competition and key non-competition venues. Furthermore, Venue Management leads the planning process and the implementation of the plans and policies, ensuring quality and consistency in line with the OCOG's policies and requirements.

The venues are ultimately managed by a venue-specific Venue Manager who is accountable for coordinating the overall operation of the venue.

### **Accessibility provisions**

Planning for accessibility is not identical to planning for the Paralympic Games. Effective planning to accommodate the needs of persons with a disability is an Olympic issue as much as a Paralympic issue. Thus, accessibility planning is addressed in all phases of venue design, development and operational planning.

The role of Venue Management in planning for and finally implementing accessibility is critical, as it leads the operational planning and all the resources of the venues.

A key consideration during the planning phase is to ensure that CAD drawings adequately depict accessibility elements. This allows operational planning to monitor the stakeholder group flows and ensure that access for people with a disability is efficient throughout the venue. This planning process also assists in identifying the accessibility overlay requirements.

The Venue Managers at Games-time monitor that plans are properly implemented. Under their leadership a thorough assessment of accessibility compliance takes place with the FAs that represent the various stakeholder groups, in order to verify adequacy of provisions. As such, the FA has a good understanding across Technical Specifications in Chapters 3-6 of how to create an accessible environment, with

additional focus on evacuation policies (see Section 3.7 Emergency provisions and Section 4.10 Evacuation routes).

### **Paralympic considerations**

Although accessibility is a Games-wide issue, the organisation of the Paralympic Games presents unique challenges due to the number of stakeholders with a disability that participate, especially athletes and Paralympic Family members.

For this reason, an effective operational planning process for the Paralympic Games includes a thorough evaluation of accessible infrastructure: for example, ensuring that venue evacuation plans adequately address the large number of wheelchair users that will be present during the Paralympic Games. For this task, the OCOG seeks expertise (either within the FA or via external consultants) with experience in Paralympic integration and accessibility planning.

The requirement for ensuring accessible exits and emergency/safety planning during the Paralympic Games for people with an impairment is specified in the HCC - Operational Requirements.

Best practice is for the OCOG to lead an audit team which will oversee the Paralympic operational planning, in the pre-Games period, with operational accessibility according to real demands as a primary focus. Venue Management will also work closely with Venues and Infrastructure FA and the IPC to facilitate an assessment of accessibility compliance during the transition period.

## **7.5.29 VENUES AND INFRASTRUCTURE**

The Venues and Infrastructure FA is responsible for overseeing venue design and construction and for temporary installations at competition and non-competition venues. All venues, even existing facilities, require some level of additional temporary development to meet the unique requirements of the Olympic and Paralympic Games.

The extent of overlay at each venue varies depending whether the venue is a) an existing permanent structure requiring permanent and/or temporary modification for Games use, b) a permanent structure purpose-built for the Games, or c) a temporary structure purpose-built for the Games.

At Games-time Venues and Infrastructure FA manages Site Management, which is responsible at the venue level for the installation of overlay elements, venue maintenance and technical issue resolution in co-operation with potential venue owners, state agencies, etc.

## Accessibility provisions

The role of Venues and Infrastructure on accessibility is critical, as it is this FA that leads the recording and planning of additional overlay features that are required for the venues to be accessible for all stakeholder groups. As such, the FA has a good understanding across technical specifications in Chapters 3-6 in creating an accessible environment.

In order to fulfil this role, the FA has expertise (either within the FA or via external consultants) in accessibility planning. Also, the FA incorporates an accessibility review into every design and overlay drawing revision stage.

The OCOG develops targeted standards for the Olympic and Paralympic Games by using this Guide as a reference tool and ensures that its delivery partners include provisions for accessibility in their tenders for venue design, construction or renovation.

The requirement for developing targeted standards using the IPC Accessibility Guide as reference, and that delivery partners include accessibility provisions in their tenders, is specified in the HCC - Operational Requirements.

At Games-time the site managers ensure proper installation of accessibility features. A thorough assessment of accessibility compliance takes place in every venue in co-operation with Venue Management and the FAs that represent the various stakeholder groups, in order to verify adequacy of provisions.

## Paralympic considerations

The accessibility manager or appointed expert is part of an audit team that oversees the Paralympic operational planning during the pre-Games period.

The assessment of accessibility compliance is repeated during the transition period, in view of the enhanced expected demand and the profile of the various stakeholder groups for the Paralympic Games.

At Games-time, the accessibility experts or other resources have a central role for accessibility issues resolution. Such resources may have a role in an 'accessibility call centre service' that should operate throughout the Games period.

### **7.5.30 VILLAGE OPERATIONS**

Village Operations is responsible for planning and operating the housing of athletes and team officials in the Olympic and Paralympic Village(s) (providing accommodation, catering and leisure facilities). Other villages may be established if

needed to accommodate other stakeholder groups, which might include media villages, technical official villages and/or a grooms' village.

Village Operations ensures that the athletes and team officials have a great Village experience and live in a safe, well protected, comfortable residential accommodation with excellent services, so that they have every chance of giving their best in competition.

### **Accessibility provisions**

Accessibility planning is addressed in all phases of Village design, development and operational planning. Village Operations leads the operational planning and all the resources of the venue; thus, its role is critical for both planning and implementing all necessary accessibility features in the Village.

Although accessibility in the Village is mainly needed for the Paralympic period, it is important that the vast majority of infrastructure and overlay is already installed prior the opening of the Olympic Village, in order to minimise transition changes.

For specific information regarding accessibility considerations for the Village, see Section 7.4.2 Olympic and Paralympic Villages.

### **Paralympic considerations**

Planning for accessibility for the Paralympic Village presents unique challenges because of the number of residents with a disability that will be accommodated there - namely athletes, team officials and potentially Games officials.

An effective operational planning process for the Paralympic Village requires expertise (either within the FA or via external consultants) with experience in Paralympic residents' needs.

In addition to the facilities available during the Olympic Games, the Paralympic Village(s) also contains the orthotic, prosthetic and wheelchair repair centre in the Village Plaza and wheelchair storage facilities in the residential zone.

Instructions for the use of items around the Village (i.e. washer and dryer) should be provided in English at a height readable by a person of short stature or someone sitting in a wheelchair. Best practice is to provide signage with pictograms, so language is not a barrier. If the equipment provides audible instructions, they must be activated to be usable by people with visual impairments.

The requirement for providing Paralympic Village(s) residents with facilities and services scaled to the needs of the Paralympic Games is specified in the HCC - Operational Requirements.



## **7.6 MOBILITY SERVICES (OR GAMES MOBILITY)**

Mobility Services (or Games Mobility) is a service offered during the Olympic and Paralympic Games. The objective of Mobility Services is to deliver high-quality access and mobility services for spectators with permanent or temporary disabilities/restrictions to use in the common domain and in selected venues at Games-time, enabling them to have full independent access to the Games experience.

### **7.6.1 OBJECTIVE**

Mobility Services provides a bridging service designed to assist with the movement of spectators with limited mobility from transport drop-off points through the large public circulation areas and around Olympic and Paralympic venues.

### **7.6.2 POTENTIAL SERVICE USERS**

Games Mobility provides services to a wide range of people with a disability, including people who use wheelchairs, people who have a visual impairment, people who have a hearing impairment and people who have a mobility impairment.

Games Mobility also provides this service to other groups, in particular people with a temporary injury (such as sprained ankle and fractures), pregnant women and older people. So as not to exclude certain spectators from using this service, it may be useful to describe the whole customer group as people with reduced mobility.

It should be noted that Games Mobility will not be used by all spectators who have a disability.

### **7.6.3 SCOPE OF SERVICES**

While the service is useful in every venue, it is essential in venues where the distance from public transport stations and parking areas to the venue is significant. This applies in an Olympic Park, its main stadium, the common domain and adjacent sporting venues. The OCOG determines in which additional venues mobility services are to be provided. It is essential to carry out research and consultation to determine whether additional services are required to make both the Olympic and Paralympic Games truly inclusive.

It is important to offer a range of mobility services to customers with reduced mobility. The following services are the five core services that are integral to a successful Games Mobility service.

#### **1. Loan of manual wheelchairs**

This service provides for the short-term loan of manual wheelchairs on the day of an event, to enable ticketed spectators to move around the common domain and to get

to their seats more easily. It is presumed that spectators will self-propel or be assisted by friends or family members. Depending on OCOG policies and where necessary, volunteer staff can assist.

## **2. Loan of power wheelchairs or power scooters**

This service provides for the short-term loan of power wheelchairs or scooters on the day of an event, to enable ticketed spectators to move around the common domain and get to their seats more easily. Volunteer staff may provide training in the safe use of the equipment.

## **3. Guide for visually-impaired spectators**

This service provides volunteer staff, trained in guiding techniques and disability awareness, to guide ticketed spectators with a visual impairment to their seats.

## **4. Guide for people using wheelchairs**

This service provides volunteer staff, trained in guiding techniques and disability awareness, to guide ticketed spectators using wheelchairs to their seating positions.

## **5. Golf buggy transfer**

This service provides all potential customer groups with easy transfer from the Games Mobility Centre to venue entrances and return by golf cart. Trained volunteers drive the golf buggies.

### **Best practice for Games Mobility services**

- OCOGs provide a Games Mobility service to serve the common domain and adjacent sporting venues.
- OCOGs ensure the five core services of Games Mobility are provided to enable an inclusive Games experience for all spectators.
- OCOGs carry out research and consultation to determine whether any additional services are required.

### **Additional comments regarding scope of programme**

Games Mobility equipment is not for use for any activity other than those related to a spectator visit to the Games. In this instance the notion of a spectator is not limited to those who hold tickets but is extended to people who have the right to spectate competitions, such as accredited individuals. Therefore, the service operates within a clearly identified secure geographical area.

For insurance and health and safety reasons, Games Mobility staff do not physically lift spectators who have a disability into or out of wheelchairs or seats.

Games Mobility is not a personal care service and cannot provide assistance with spectators' personal hygiene, feeding or medication.

Games Mobility is not a substitute for FAs implementing inclusive operational procedures. Rather, this service complements the operational procedures that Event Services puts in place to assist people with reduced mobility of any kind.

Games Mobility is not a service for medical emergencies.

### **7.6.4 STAFF**

Games Mobility staffing levels reflect the anticipated number of services to be provided and the size of the geographical area covered. Staff include Games Mobility assistants, Games Mobility team leaders and Games Mobility managers.

#### **Staff training**

- **Equipment training** - The different types of equipment provided and how to operate; showing customers how to operate; health and safety of equipment use; physical practice session.
- **Escorting people with a visual impairment** - How to provide a guide service for people with a visual impairment.
- **Escorting people using wheelchairs** - How to provide a manual wheelchair escort service.
- **Games Mobility procedures familiarisation** - How the booking system works; checking in; service procedures and process; communications; unloading/storage of kit.
- **Games Mobility terminology and etiquette** - Disability awareness; appropriate terminology; guidance on accessible facilities, etc.
- **Generic training** - Introduction to Event Services; health and safety; accreditation; customer care; radios; golf carts.

For additional information regarding disability and accessibility awareness, see Section 7.3 Staff Awareness and Training. As any staff member - not just those part of the Games Mobility Service - may interact with a person with a disability, the OCOG establishes a comprehensive training package for all staff.

### **7.6.5 EQUIPMENT**

It is vital to ensure there is a variety of mobility equipment for customers to use. This includes a combination of powered units (scooters and wheelchairs) and self-propelled manual wheelchairs.

Golf buggies, driven by trained Games Mobility staff, are an essential tool for this service. A dedicated fleet of golf buggies enables the comfortable transportation of large numbers of spectators with reduced mobility and is preferred by many customers who are uncomfortable with the idea of using a wheelchair.

During the planning stages of the Games, the FA responsible for Games Mobility engages with the appropriate FAs to secure its own dedicated fleet of golf buggies.

### **7.6.6 LOCATION AND PARKING**

The Games Mobility Centre is located close to the main spectator transport hub to enable a smooth and easy transition from public transport to Games Mobility services. Integrating Games Mobility into mainstream transport planning ensures a seamless service for spectators and is the hallmark of an inclusive approach.

This ensures potential customers do not have to travel far from transport drop-off zones to the Games Mobility Centre and that Games Mobility assistants can be prompt in providing a temporary transfer service through security control.

It is important to ensure that Games Mobility has its own dedicated parking close to the Games Mobility hub, no more than 50m from its location. Parking can be pre-booked along with equipment or assistance that allows for a complete, seamless service to operate - enabling spectators with a disability to arrive comfortably and without travelling excessive distances.

It is essential for the Games Mobility service to be located within the common domain inside the secure zone of the area it serves. This ensures:

- The equipment is not used for any activity other than those related to a spectator visit to the Games.
- Security of expensive equipment during and outside event times.
- Security of management staff when in the office during early and late hours.
- Proximity to electricity, which is needed for re-charging equipment.
- A reduction in trips time, as equipment and Games Mobility assistants providing escorts do not need to continually pass through security screening checkpoints.
- Proximity to potential Games Mobility customers who have already entered the common domain and have realised they need some assistance.

A fixed Games Mobility Centre also eliminates the need to pack and un-pack the office and reception area each day, which unnecessarily lengthens shift times and puts more physical exertion demands on an already physically demanding service.

### **7.6.7 ACCREDITATION**

Although based in the common domain, Games Mobility services also operate inside venues, taking customers to their seats where necessary. Therefore, it is essential that all Games Mobility workforce is provided with appropriate accreditation (with multi-venue access or infinity) or upgrade passes to allow for a flexible, fast and efficient service.

While the main operation of the Games Mobility service will be in public areas, there are occasions where back-of-house access and access into other accredited areas

will be needed for the rapid transfer of equipment/staff, or to accompany spectators in wheelchairs through areas when access via the official spectator channels is unavailable for any unscheduled reason.

# **CHAPTER 8**

## **REFERENCE MATERIAL**



## 8 REFERENCE MATERIAL

The directions and recommendations contained in the IPC Accessibility Guide draw from different sources, such as existing guides and manuals, national building codes, advice from accessibility experts, and information gathered from experiences and lessons learned from previous Games.

Below are details of the main reference material that was used to develop this Guide.

### **Figure 27: US Department of Transportation:**

[https://www.its.dot.gov/research\\_areas/attri/safe\\_crossing.htm](https://www.its.dot.gov/research_areas/attri/safe_crossing.htm)

**Mayor Office for People with Disabilities. Inclusive Design Guidelines New York City 2 Robert Piccolo, AIA, NCARB Editor in Chief**

### **ADA Accessibility Guidelines**

<https://www.access-board.gov/guidelines-and-standards/buildings-and-sites/about-the-ada-standards/background/adaag>

### **Technology and accessibility**

<http://www.washington.edu/doit/videos/index.php?vid=59>

### **Guidelines and technology**

<https://help.uis.cam.ac.uk/resources/web-accessibility-guidelines>

<https://www.w3.org/TR/WCAG20/>

### **Cambridge University**

### **Business Study and Presentation**

### **Research gate**

[https://www.researchgate.net/publication/266455460\\_The\\_Market\\_Drivers\\_and\\_Business\\_Case\\_for\\_Designing\\_Accessible\\_Public\\_Technology](https://www.researchgate.net/publication/266455460_The_Market_Drivers_and_Business_Case_for_Designing_Accessible_Public_Technology)

### **Universal vs Accessible**

<https://www.wbdg.org/design-objectives/accessible/beyond-accessibility-universal-design>

[http://www.un.org/disabilities/documents/desa/good\\_practices\\_in\\_accessible\\_urban\\_development\\_october2016.pdf](http://www.un.org/disabilities/documents/desa/good_practices_in_accessible_urban_development_october2016.pdf)



## **INTERNATIONAL PARALYMPIC COMMITTEE**

Adenauerallee 212-214, 53113 Bonn, Germany / [paralympic.org](http://paralympic.org)  
[info@paralympic.org](mailto:info@paralympic.org) / Tel: +49 228 2097-200 / Fax: +49 228 2097-209

© 2020 International Paralympic Committee - ALL RIGHTS RESERVED