

O LOCAL PARA CONSTRUIR

CONSTRUIR A CASA AFASTADA DAS ARVORES, JA QUE PODEM CAIR DURANTE O CICLONE!!

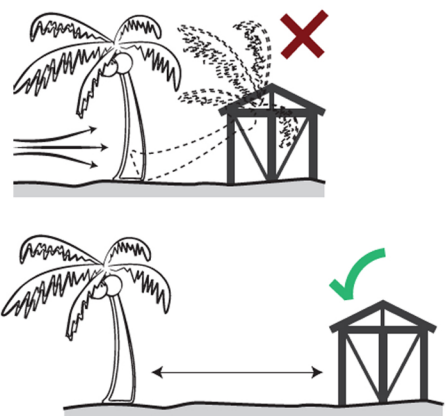

CONSTRUIR A CASA LONGE DAS AGUAS DO RIO OU DO MAR PARA EVITAR FICAR DANIFICADA PELA CHEIA E AS ONDAS !!

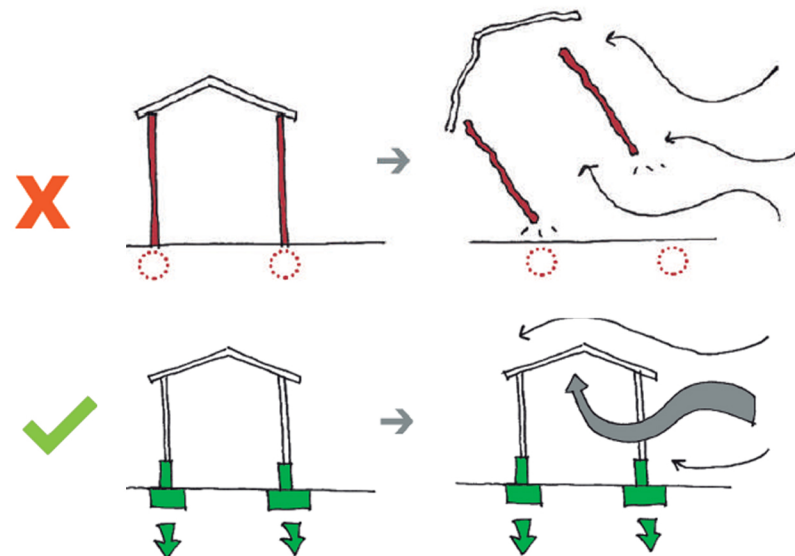
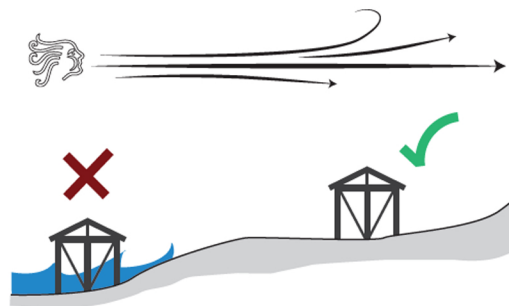

A BASE DA CASA

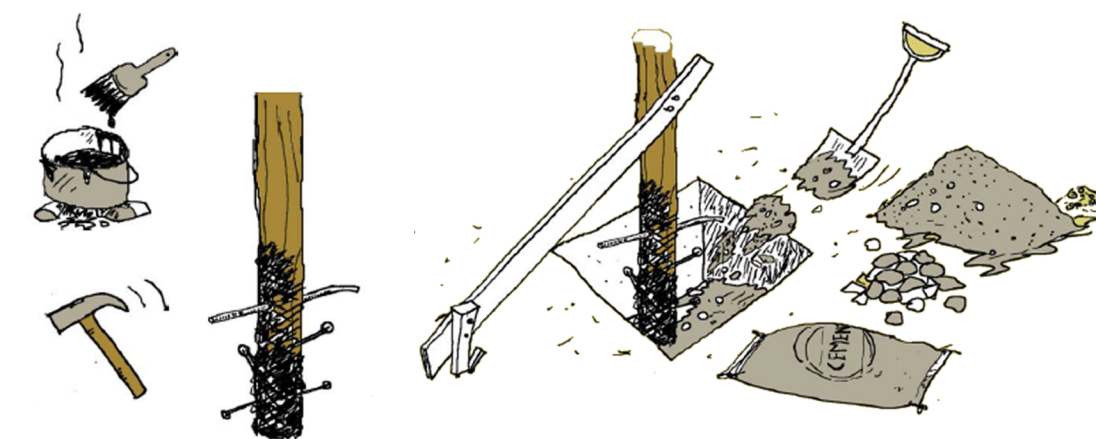

A FORMA DA CASA

UMA PLANTA COMPACTA E SIMÉTRICA É MAIS RESISTENTE

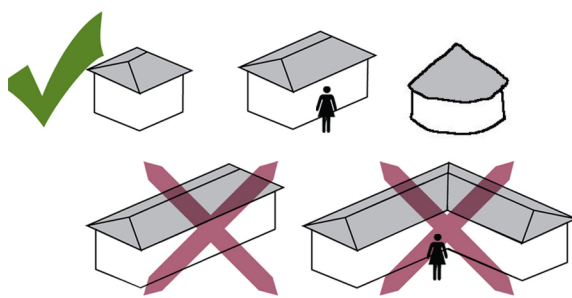

UTILIZAR REFORÇOS DIAGONAIS NAS PAREDES

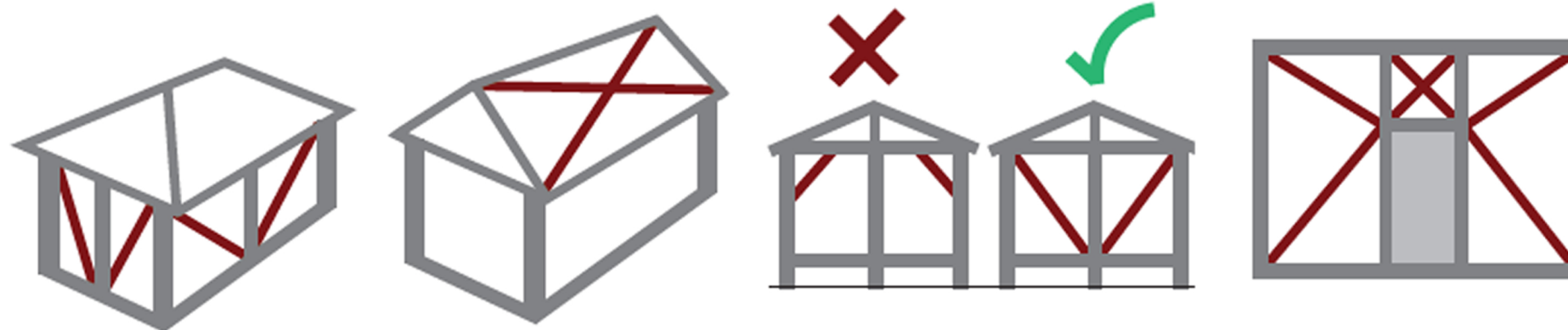

3
UM REBOCO OU MATICADO DE QUALIDADE É NECESSÁRIO PARA PROTEGER AS PAREDES!

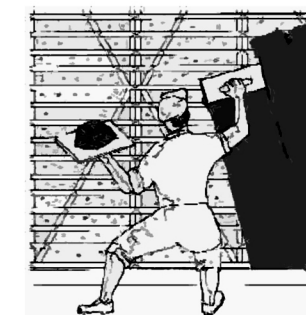

O TECTO DA CASA

COBERTURAS DE QUATRO ÁGUAS E INCLINAÇÃO MAIOR DE 30° RESISTEM MELHOR AOS VENTOS FORTES!!

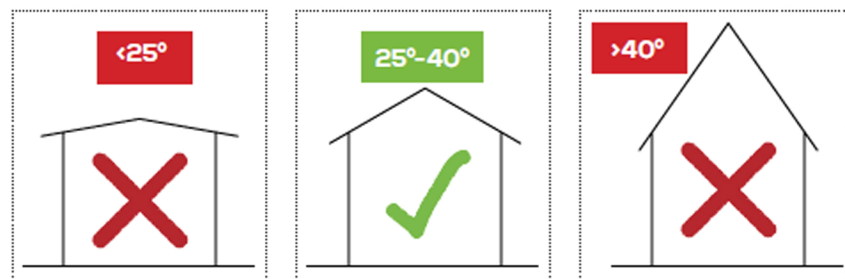

UMA VARANDA SEPARADA DA COBERTURA RESISTE MELHOR AOS VENTOS FORTES!!

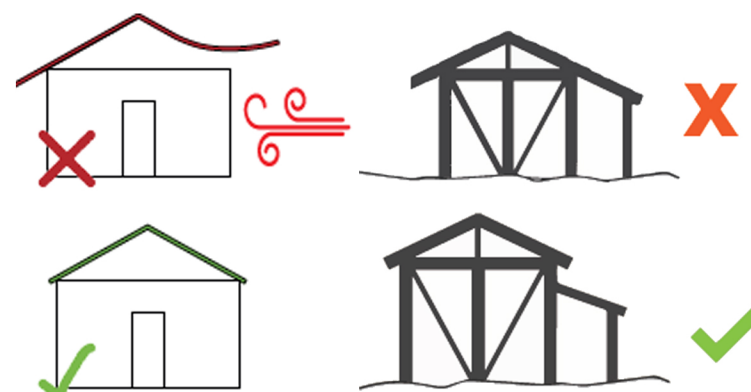

PARA TECTO DE CHAPA

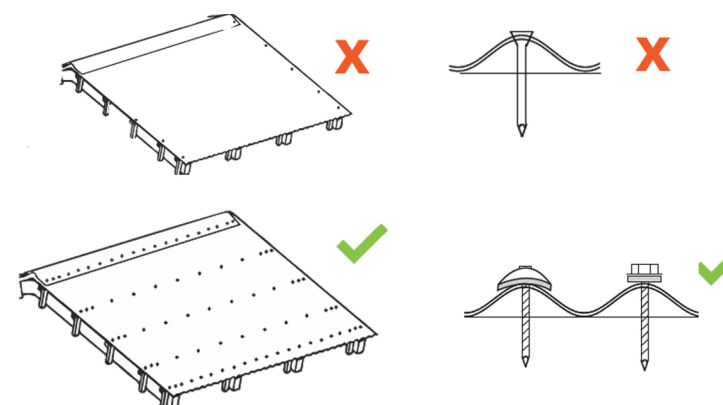

ASSEGURAR O CAPIM COM FITAS VEGETAIS!!

