

GID BON PRATIK KONSTRIKSYON

NAN GRANDANS | AYITI



International Federation
of Red Cross and Red Crescent Societies











Nan gid sa nap jwen tout bagay ki konsène tout fason nou dwe konstwi nan rejyon Grandans, Ayiti.

Tout infòmasyon sa yo montre nou tout teknik ak prinsip de baz pou nou byen konstwi, e pwoblèm sa yo konsène sa kap pase sou teritwa nou, sito pwoblèm ki gen pou wè ak katastòf natirèl.

Dokiman sa dwe sèvi nou kòm baz pou tout moun kap gen pou vin realize yon travay nan zòn nan - swa pou nou repara, swa pou nou fè yon konstriksyon - e gid sa se yon eleman de baz kap ede bòs nou yo nan travay nap fè yo.

Li pa dispansè chwa yon ekip kalifye pou realize travay la.

SIN NOU UTILIZE NAN GID SA	
 	ATANSYON ! SA NOU PA REKÒMANDE GEN DANJE SA NOU REKÒMANDE SA KI PI BON
 	DISTANS POU NOU RESPEKTE KI ASE DISTANS KI PA ASE TRÒ PRE
   	VAN GWO VAN SOLÈY EKLERAJ DLO LAPLI

li fèt pa Miguel FERREIRA MENDES | 2013
ak zouti pedagojik CRAtèrre-ENSAG | ONU-HABITAT | AECID

PWOBLÈM SYKLÒN

KI KOTE POU NOU KONSTWI KAY NOU

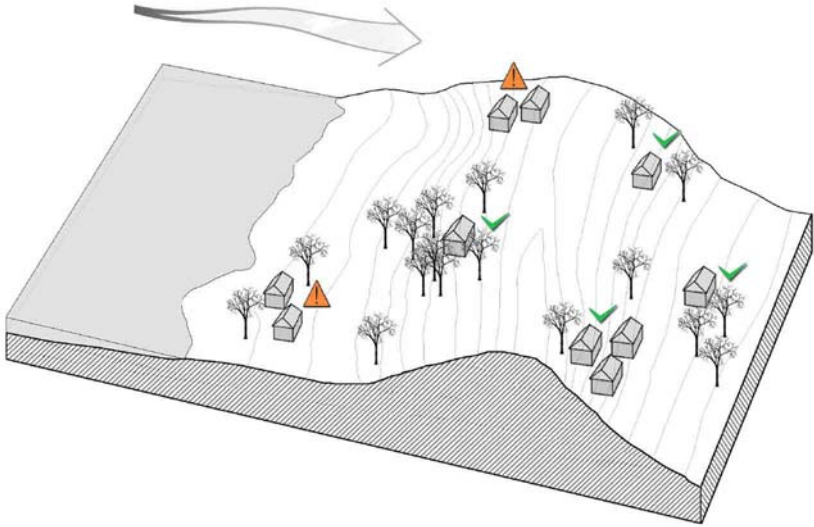

A KOTE LA MÈ A

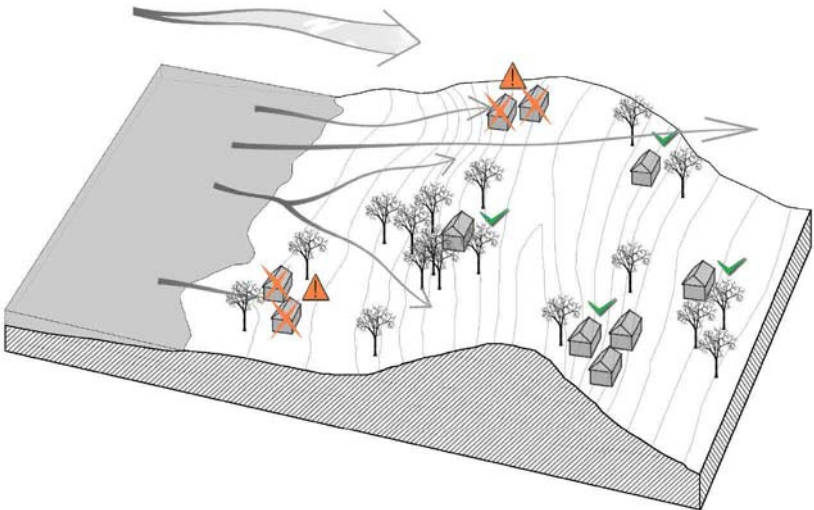

RANJE A KOTE KAY NOU

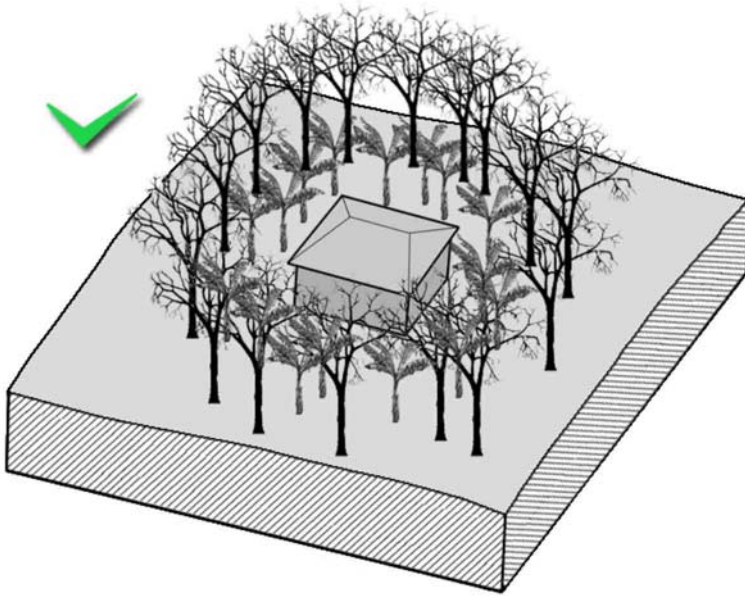

PLANTE BWA TOU OTOU KAY LA

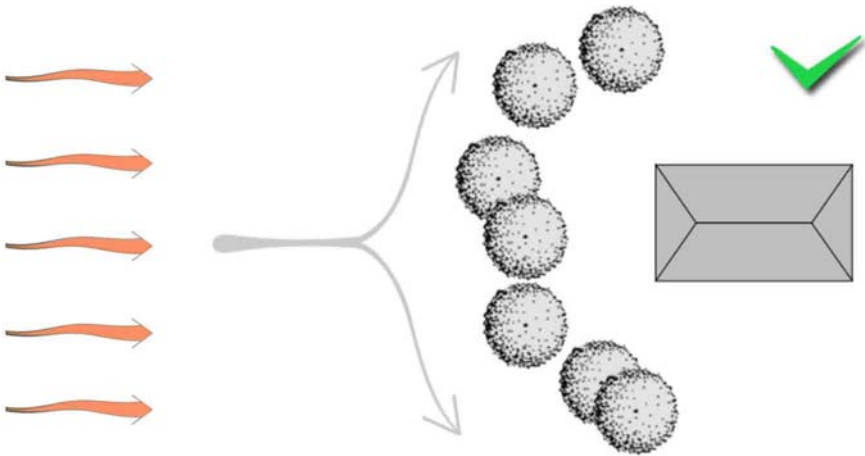

PWOBLÈM SYKLÒN

RANJE A KOTE KAY NOU



A KI DISTAN NOU DWE PLANTE E KI PLANT

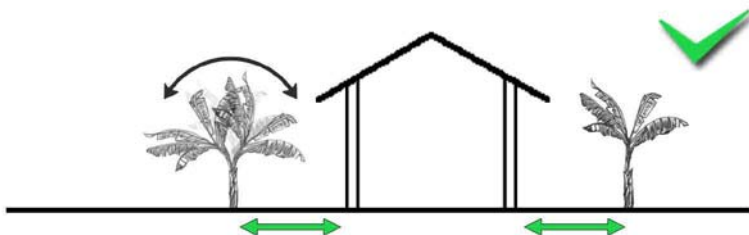
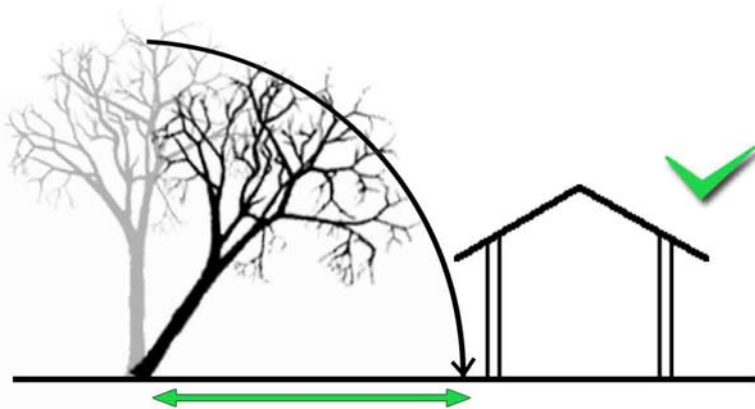

RELASYON VAN / FÒM + ORYANTASYON

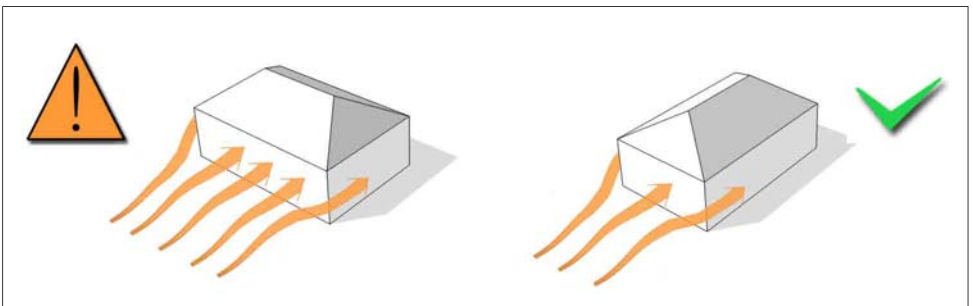
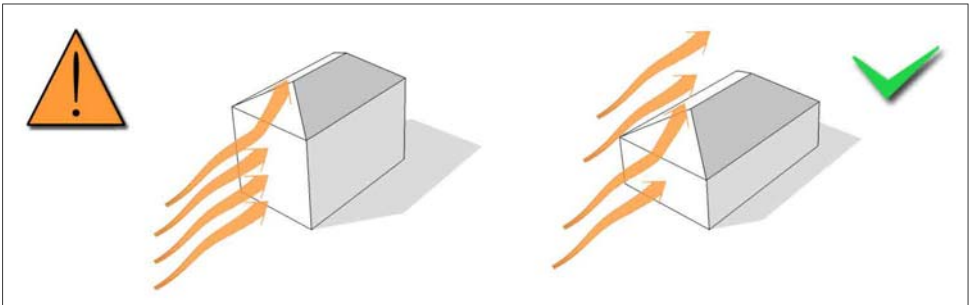
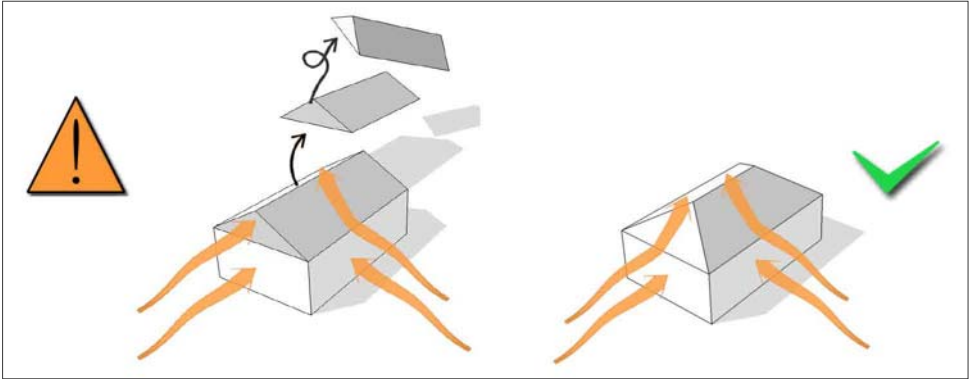

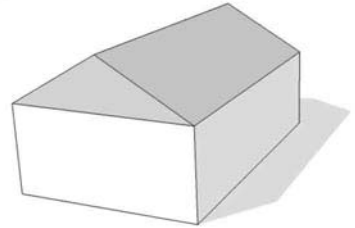
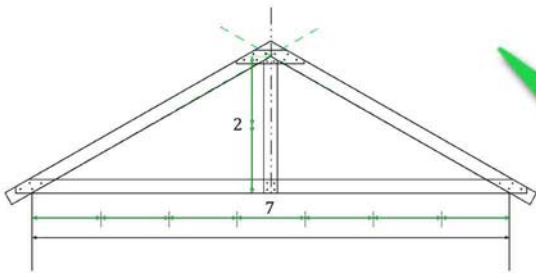
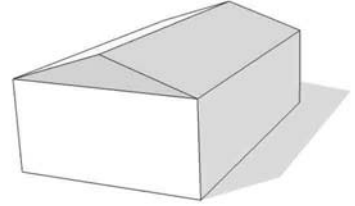
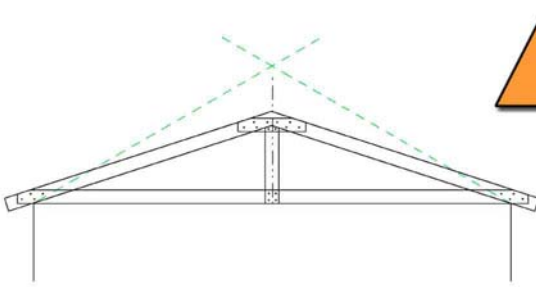

APPROX. 30° (58%)

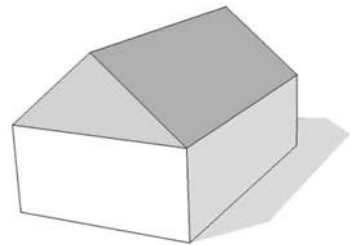
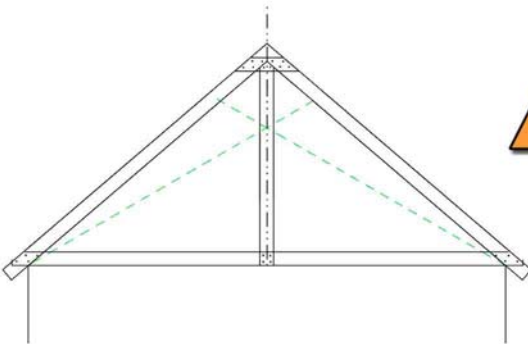

KIJAN POU NOU RANJE TÈT KAY LA

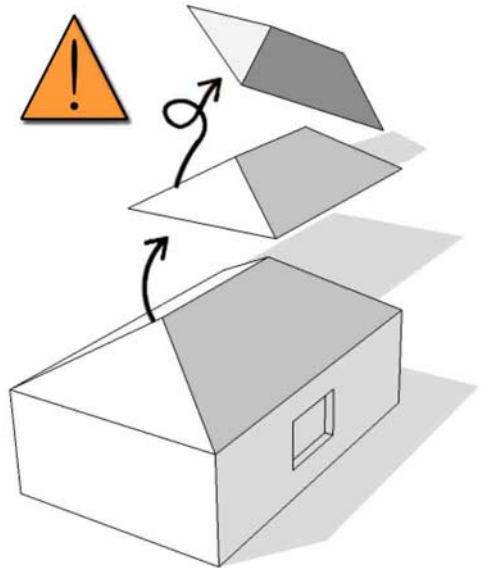
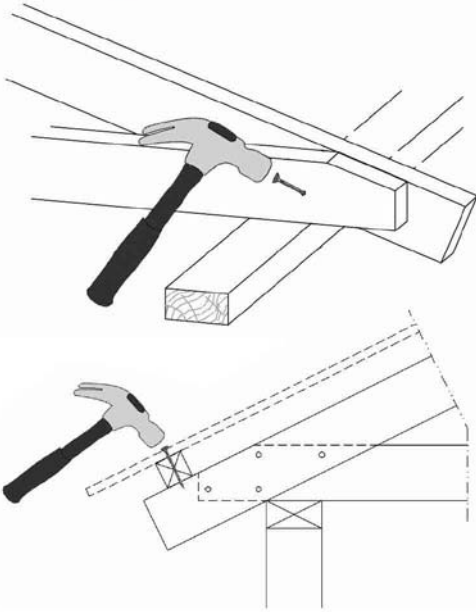

ANKRAJ AK JAN POU NOU RANFÒSE KAY LA

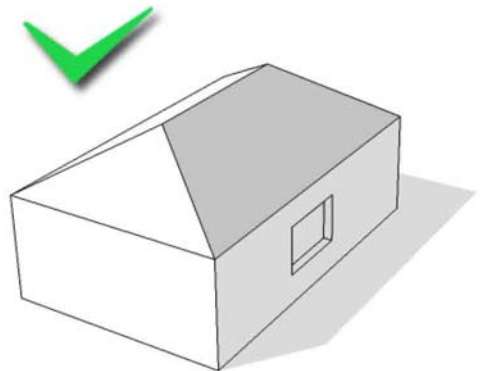
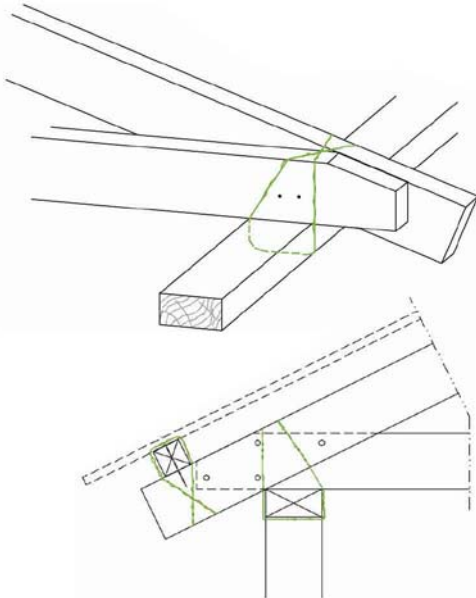

PWOBLÈM INONDASYON

KI KOTE POU NOU KONSTWI KAY NOU

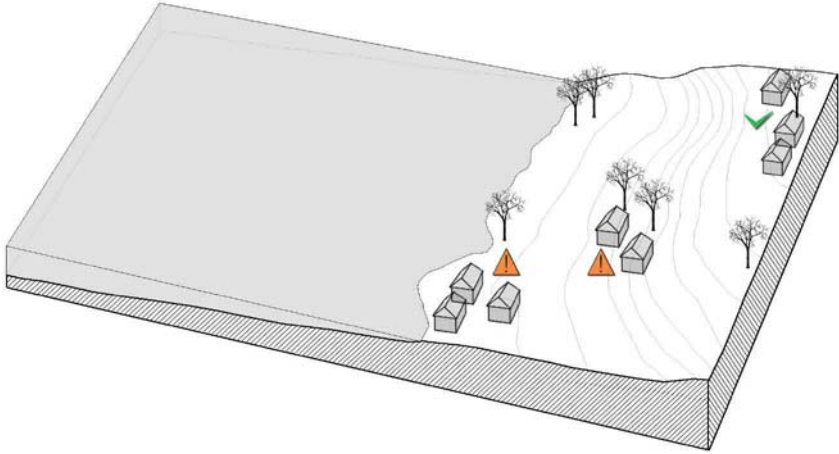

A KOTE LA MÈ A

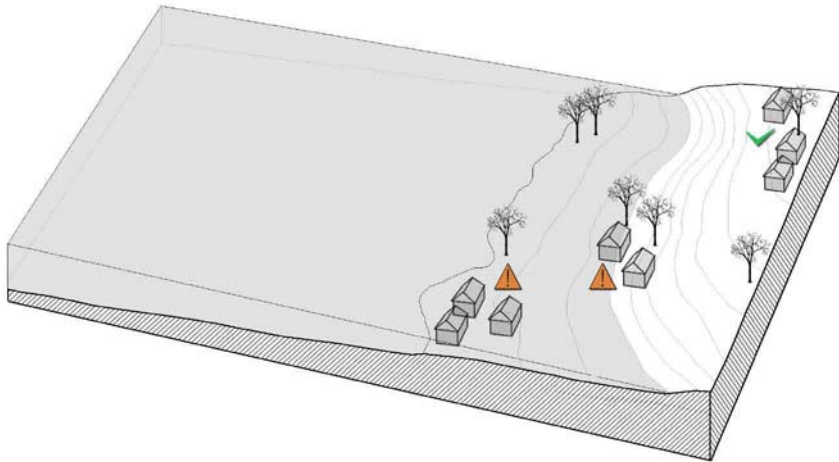

KI KOTE POU NOU KONSTWI KAY NOU

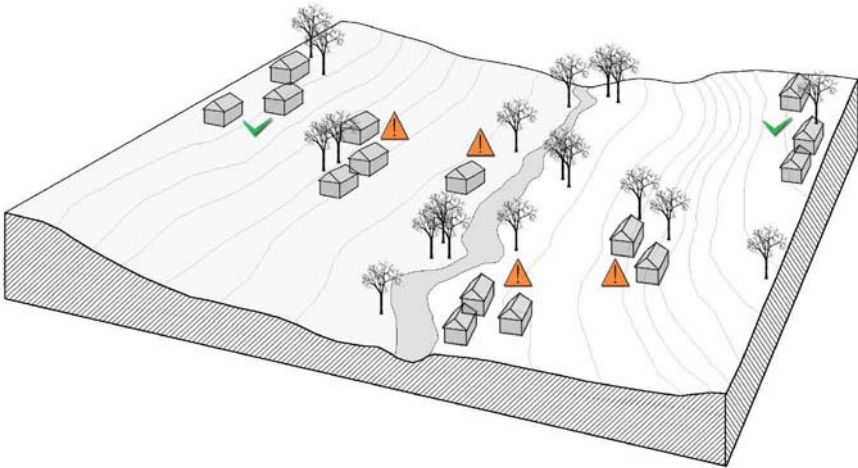

A KOTE SOUS DLO YO – FLÈV AK RIVYÈ



KI KOTE POU NOU KONSTWI KAY NOU

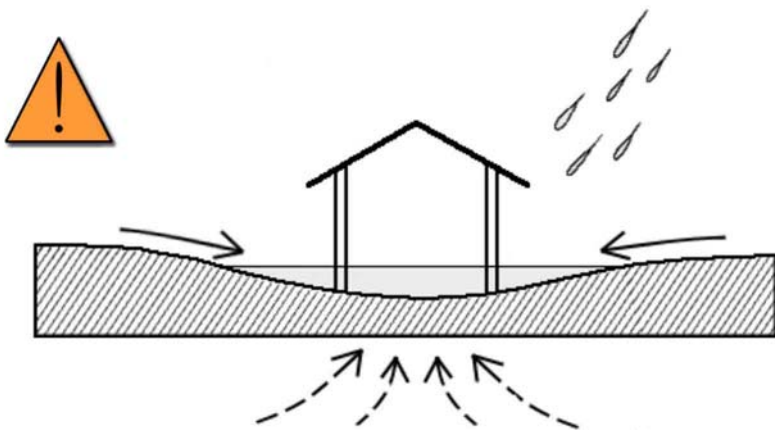

KIJAN TÈREN AN YE

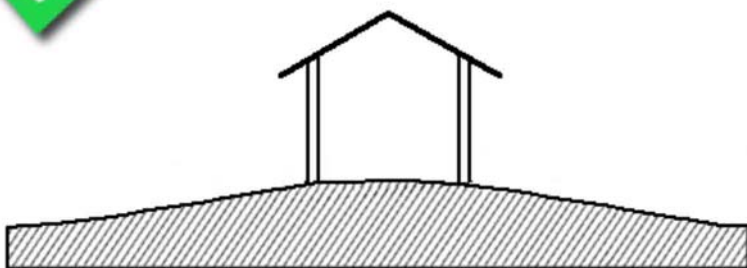

RANJE A KOTE KAY NOU

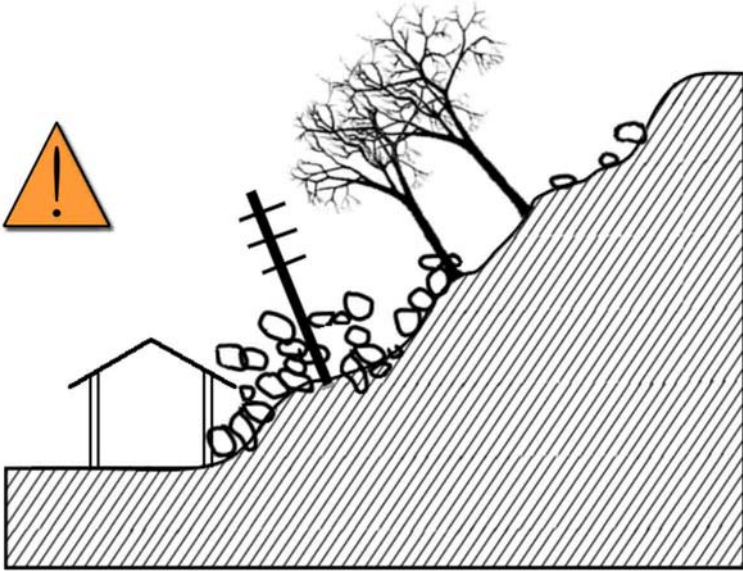

KIJAN POU NOU PLANTE SOU TÈREN AN

PREPARE YON PLATFÒM KONT DEBOULONNAY TÈ AK LÒT BAGAY KI KAPAB TOMBE

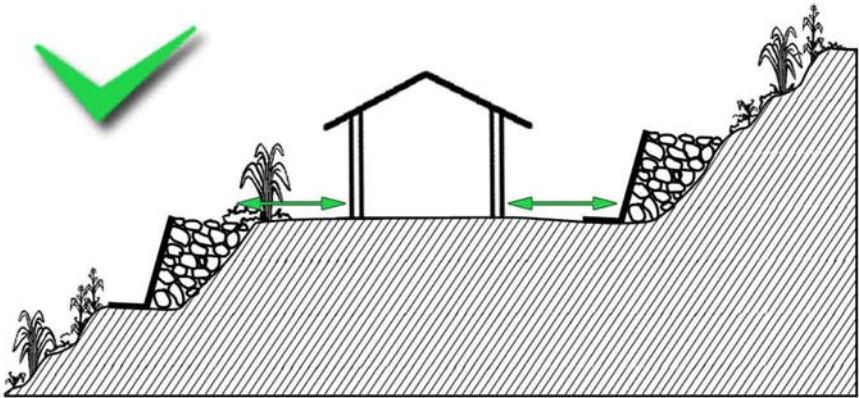

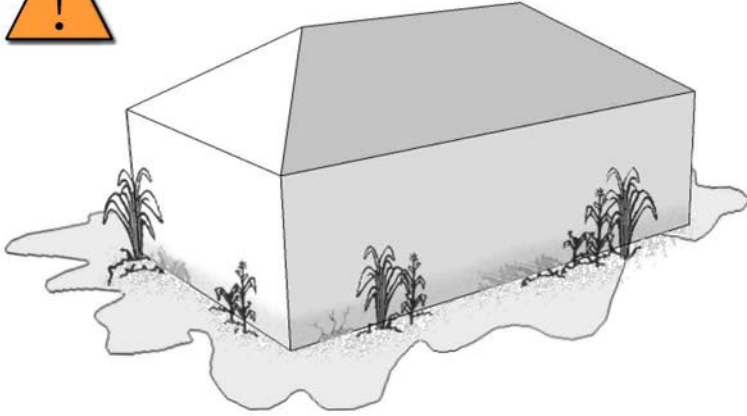
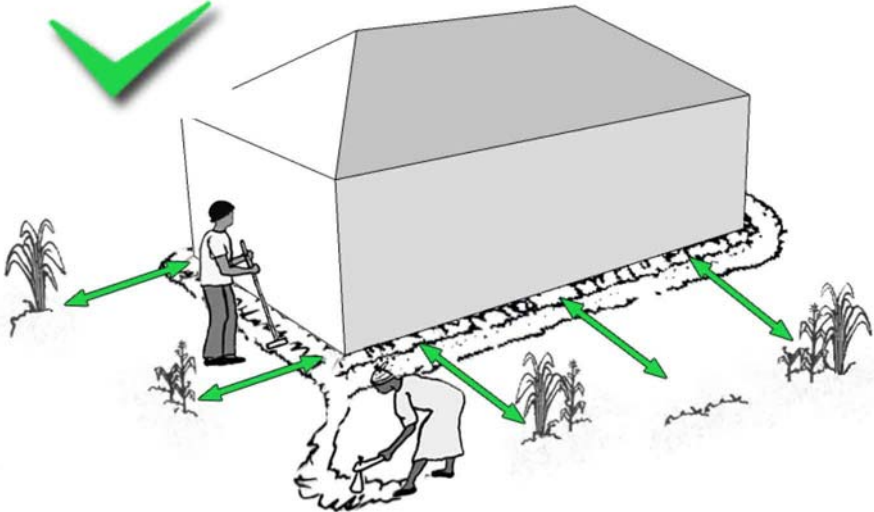
PWOBLÈM INONDASYON**RANJE A KOTE KAY NOU****PA KITE DLO RETE A KOTE KAY LA POU LI PA IMID**

KIJAN POU NOU PWOTEJE MI YO

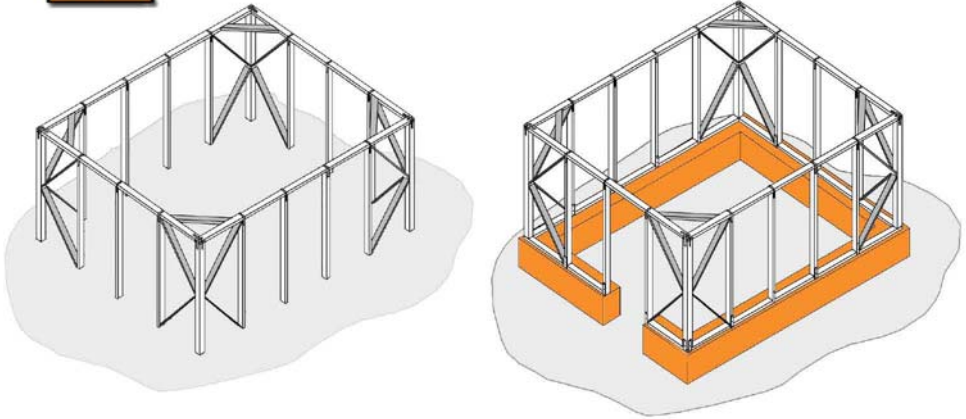

PA KITE DLO RANTRE NAN SOL KAY LA

MI AN DEDAN KAY LA DWE ELEVE AK YON ÒTÈ PI WO KE MI KI DEYÒ A

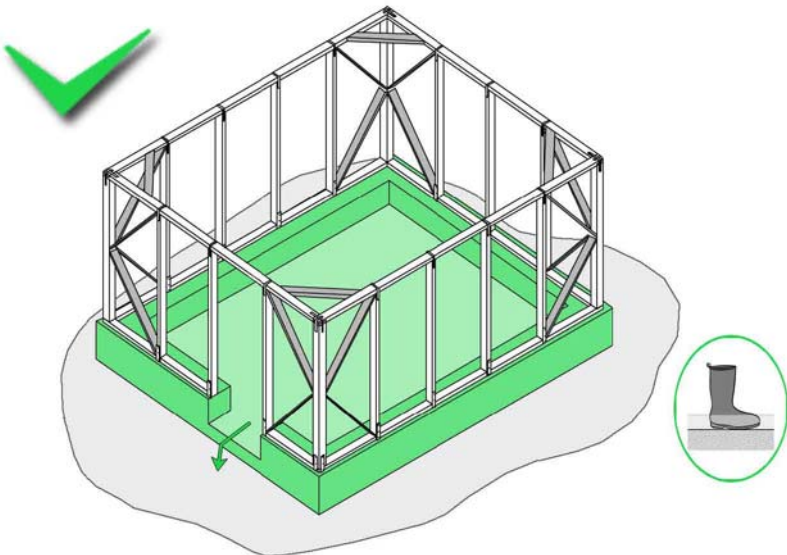

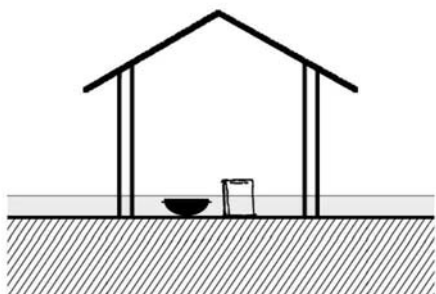

FÈ YON GALATA ANLÈ KAY LA

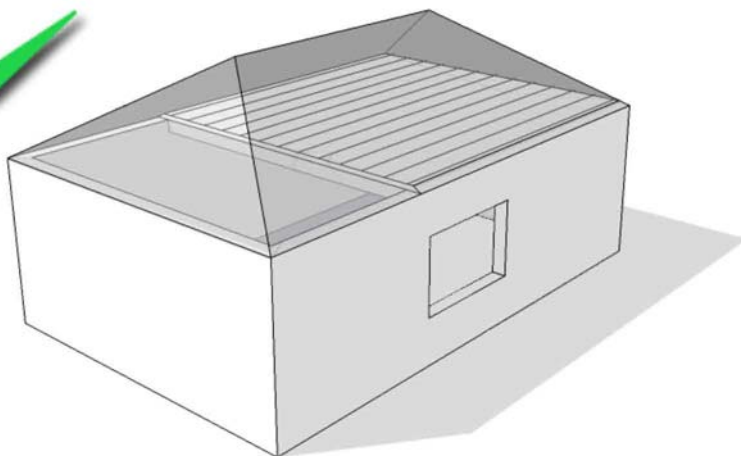

KI KOTE POU NOU KONSTWI KAY NOU

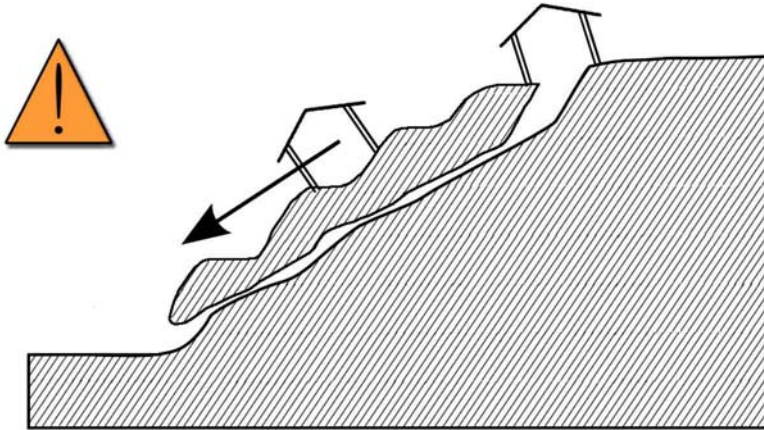

KIJAN TÈREN AN YE

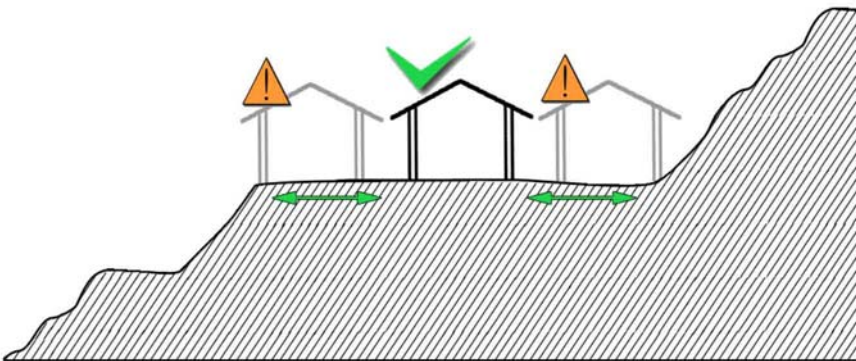

PWOBLÈM TRANBLEMAN DE TÉ

MÒD AK FASON NOU DWE KONSTWI

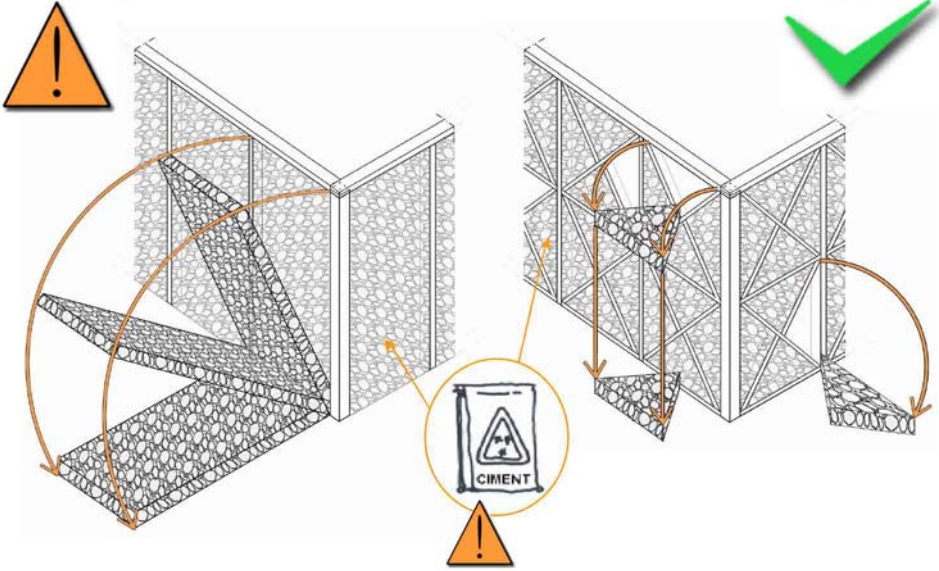

TI PANO + MÒTYE SOUP = DIMINISYON RIS YO

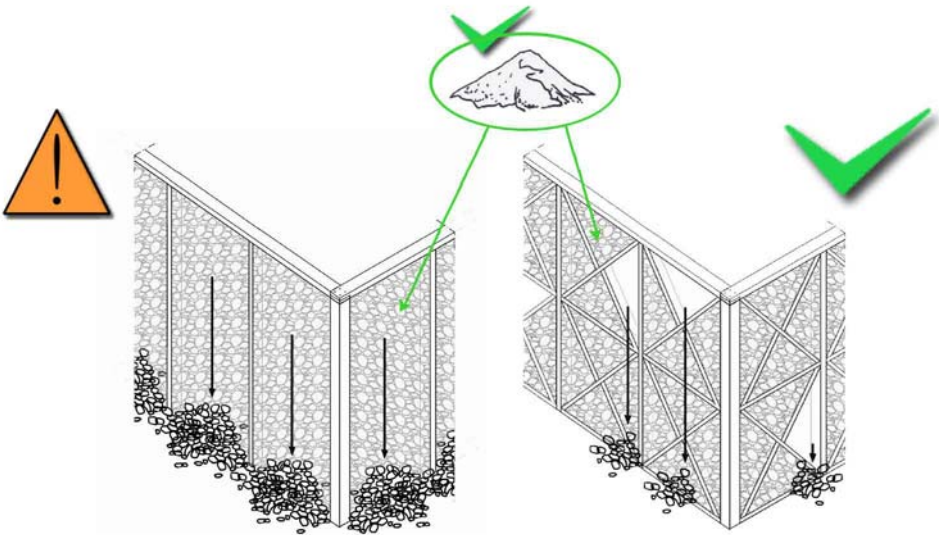

ELEMAN KI NAN KAY LA

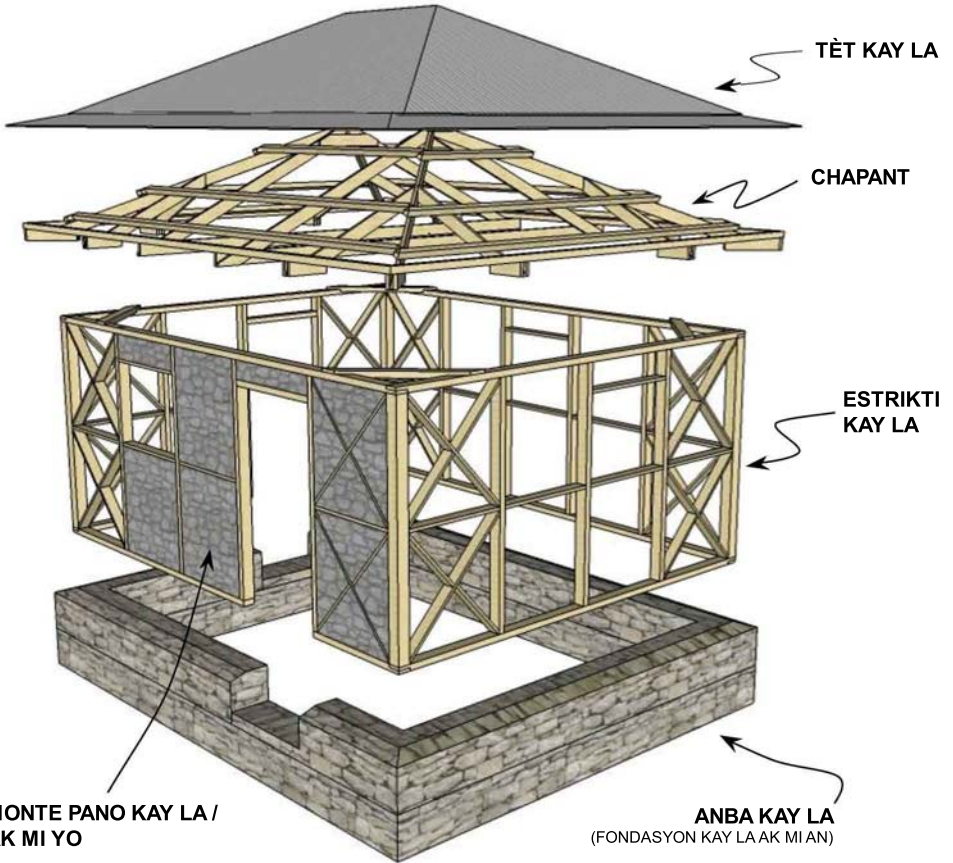
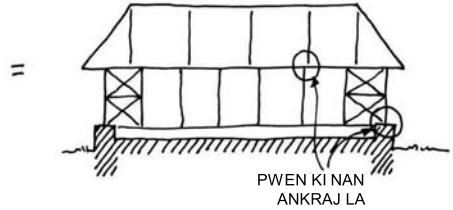
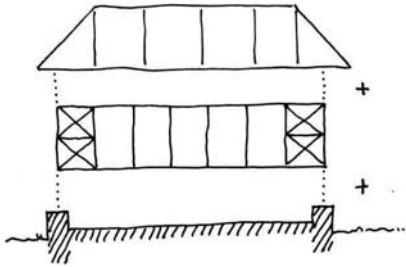

SOL KAY LA

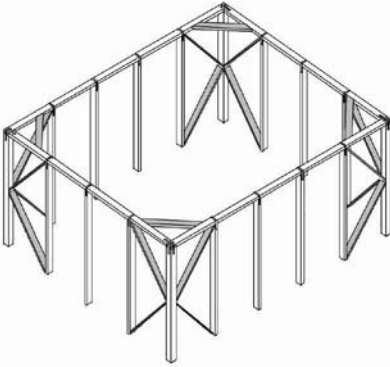

POTO NAN SOL KAY LA



PATI ANBA POTO A POURI
AK TI BÈT KI MANJE LI

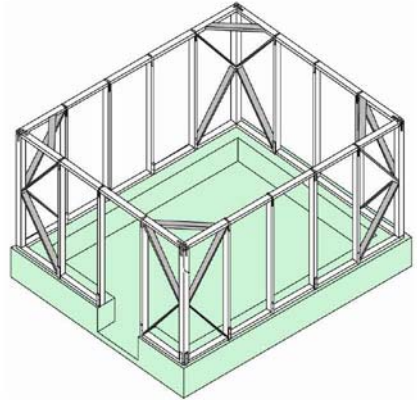

POTO AK SOL KAY LA



KIJAN POU NOU PWOTEJE ESTRIKTI
KAY LA AK BWA YO KONT IMIDITE



SOL KAY LA AN WÒCH

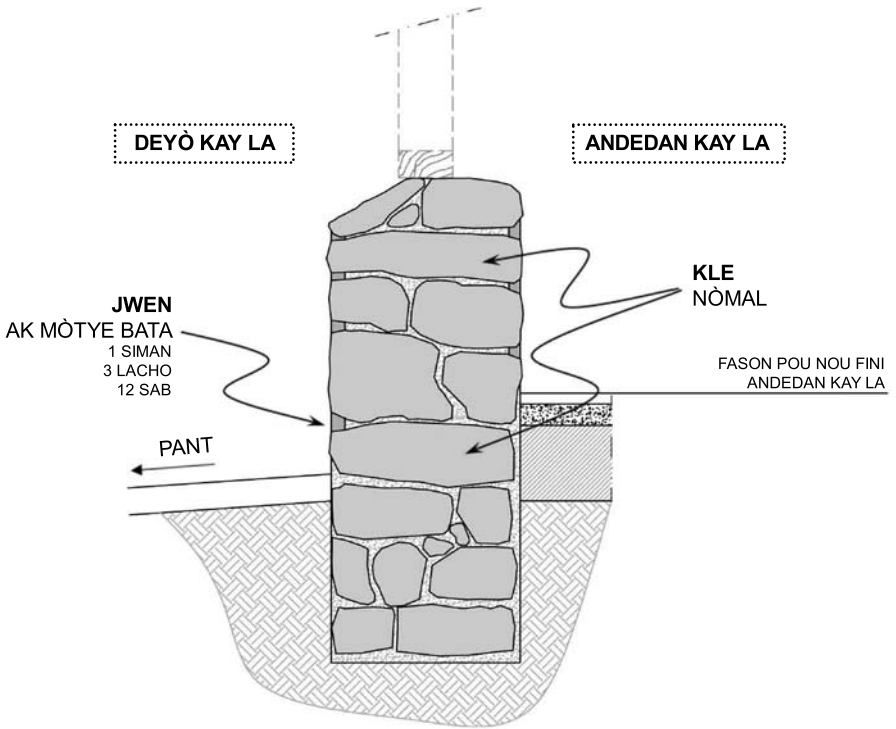

PRINSIP POU NOU KONSTWI

SOL KAY LA - PLO AN BETON

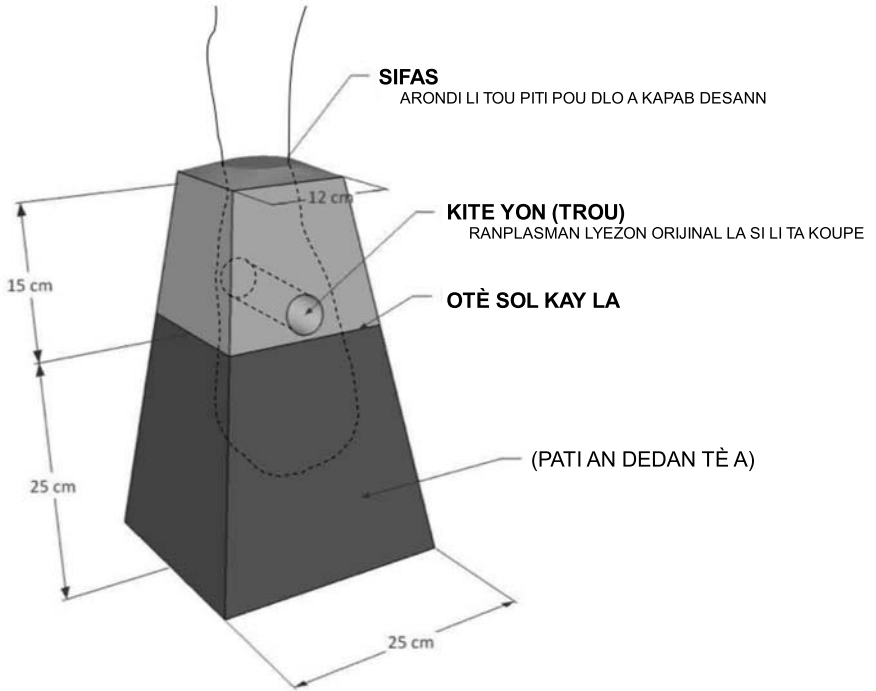

- POU NOU KA RANPLASE ANBA POTO A
- POU LI KA SIPOTE POTO ANBA GALERI A



WÒCH NAN ANG YO

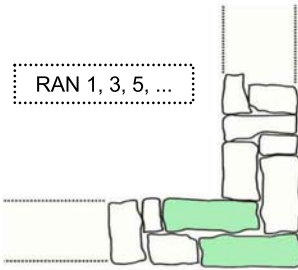

RAN 1, 3, 5, ...

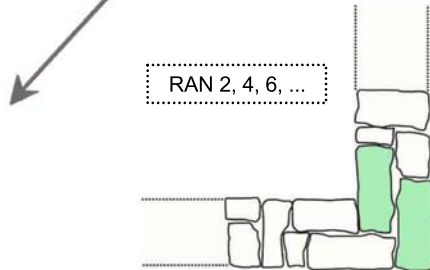

RAN 2, 4, 6, ...

KLE

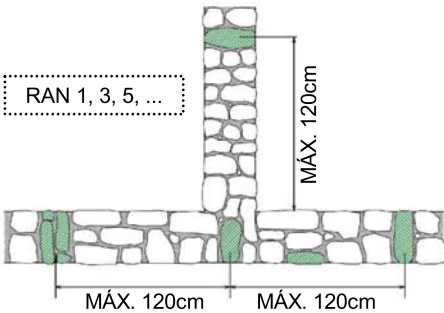

RAN 1, 3, 5, ...

MÀX. 120cm

MÀX. 120cm

MÀX. 120cm

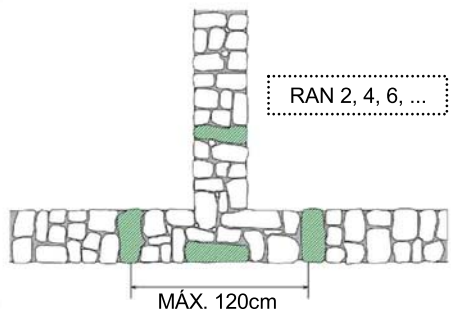

RAN 2, 4, 6, ...

MÀX. 120cm

JAN POU NOU KWAZE WÒCH YO

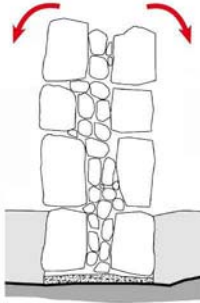

JWEN AN WO

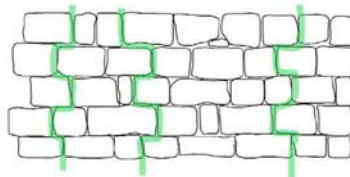
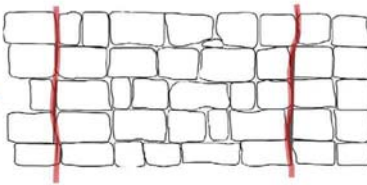

PANCHE WÒCH YO

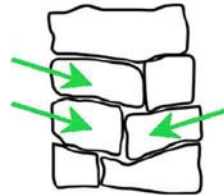

BLOKE WÒCH YO

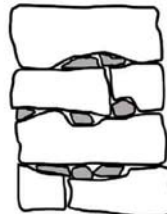
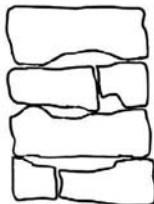

AK FIL ALIGATI GALVANIZE

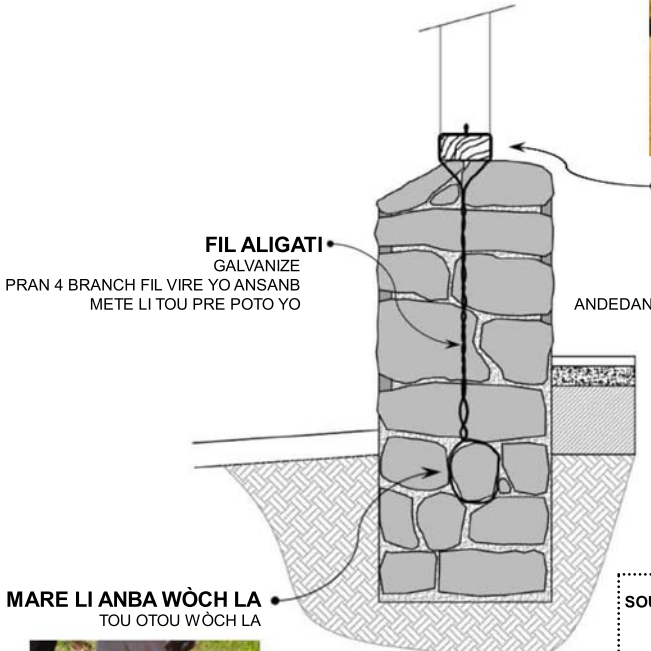

MARE LI SOU ANLÈ
OTOU LIS BAS LA

MARE LI ANBA WÖCH LA
TOU OTOU WÖCH LA



SOUBASSEMENT EN BLOCS DE BÉTON

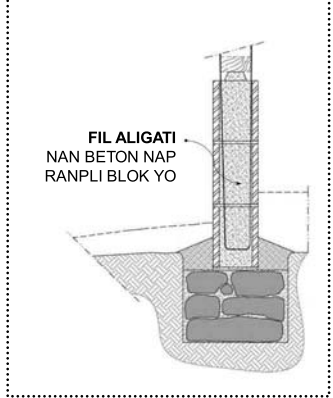

AK FÈ KI NAN BETON AN



MARE SIPERYÈ
 PLYE LI NAN LIS BAS LA
 KLOUWE LI AK KLOU 4 POU KAPAB KENBE LI

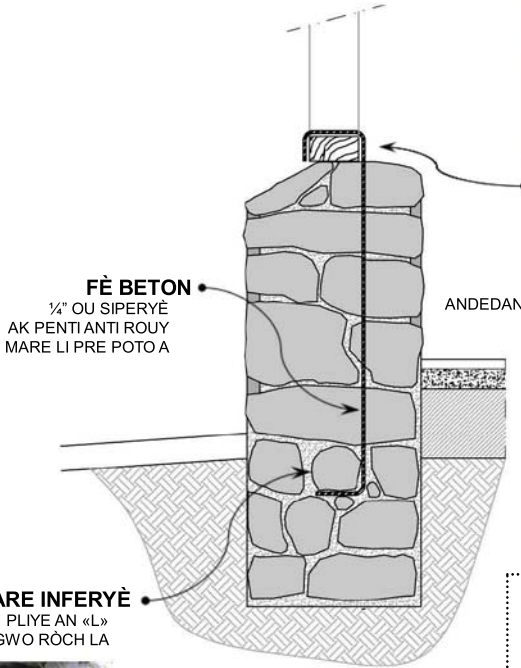

FÈ BETON
 1/4" OU SIPERYÈ
 AK PENTI ANTI ROUY
 MARE LI PRE POTO A

MARE INFERYÈ
 PLYE AN «L»
 SOU GWO RÒCH LA



SOL KAY LA EN BLOK BETON

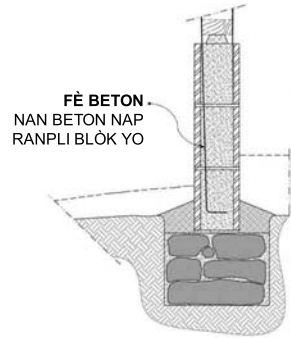

FÈ BETON
 NAN BETON NAP
 RANPLI BLÒK YO

ESTRIKTI AN BWA - KONTREAVANTMAN

POTO ANTRE NAN TÈ A
SAN LI PA KONTREAVANTE

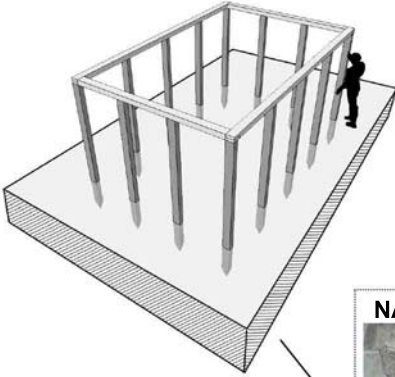

POTO ANTRE NAN TÈ A
AK KONTREAVANTMAN
(PANO NAN ANG YO AN PRIYORITE)

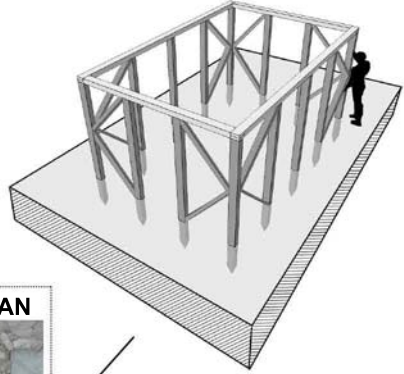

NAN ANPIL TAN



BWA AP POURI



LI KAPAB KOUPE

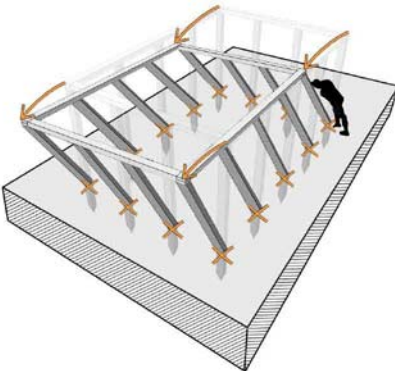

ESTRIKTI AN KENBE

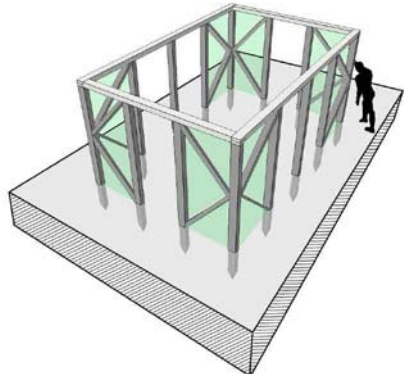

ESTRIKTI POU NOU RANPLI MASONERI AN WÒCH

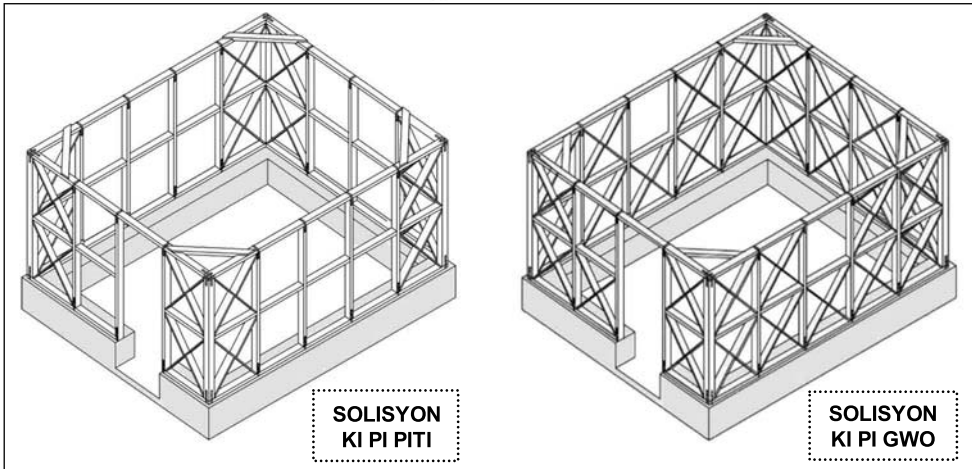
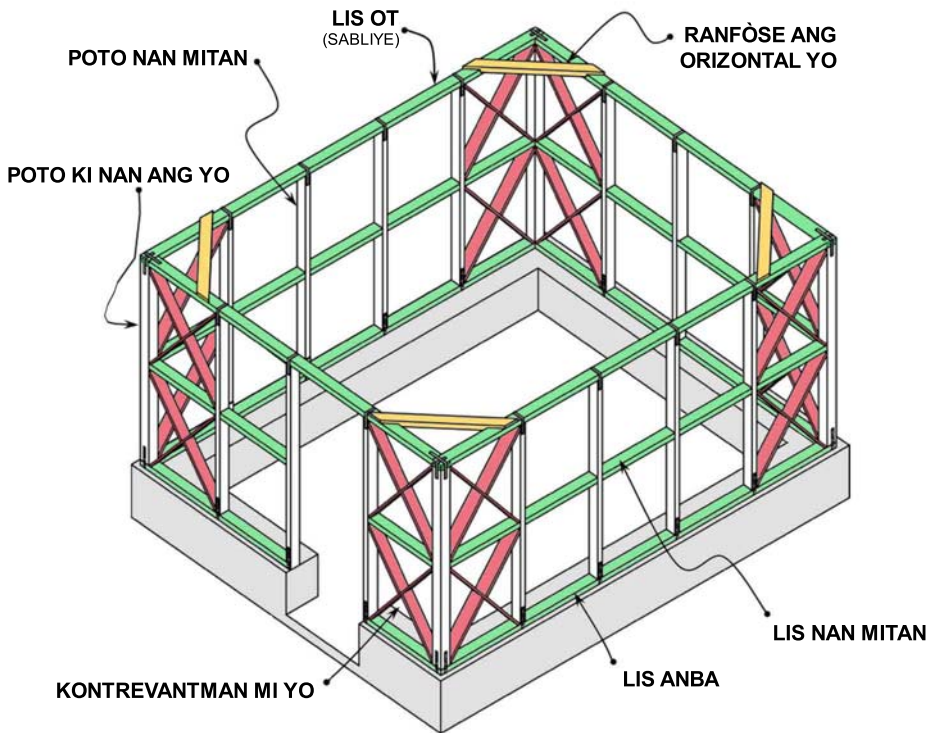

ESTRIKTI AN BWA - KONTREVANTMANT

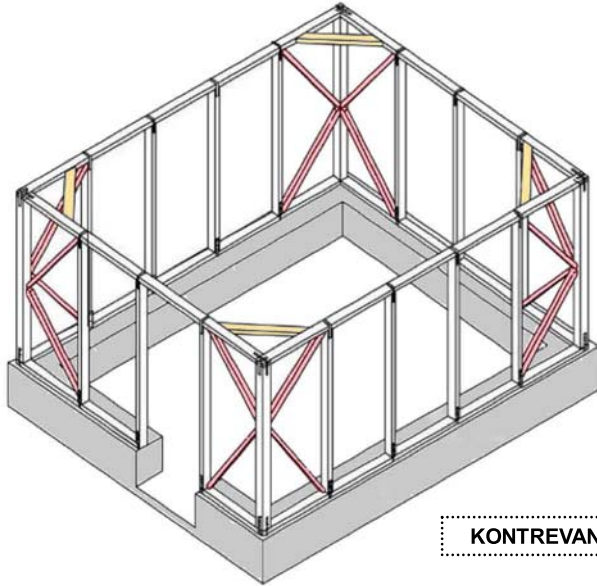

KONTREVANTMAN AN "K"

ESTRIKTI POU NOU RANPLI PANO AN KLISAD YO

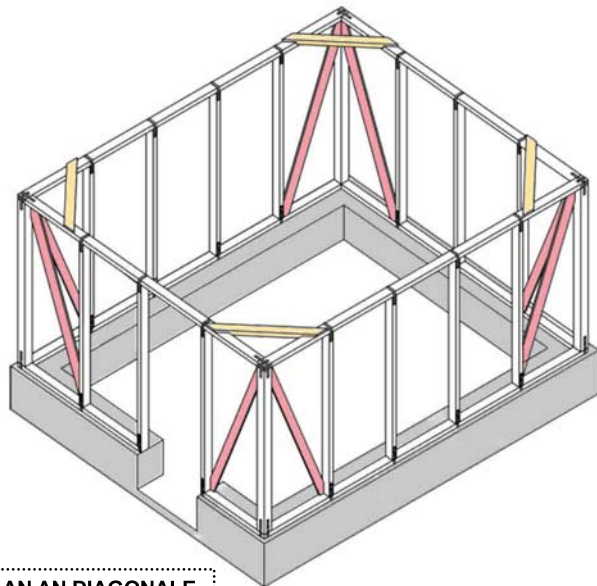

KONTREVANTMAN AN DIAGONALE

KONEKTE LIS BAS YO/OT YO – POTO AK ESTRAP

KIJAN POU NOU DIMANSYONE ESTRAP SELON GWOSÈ LIS LA BAS LA

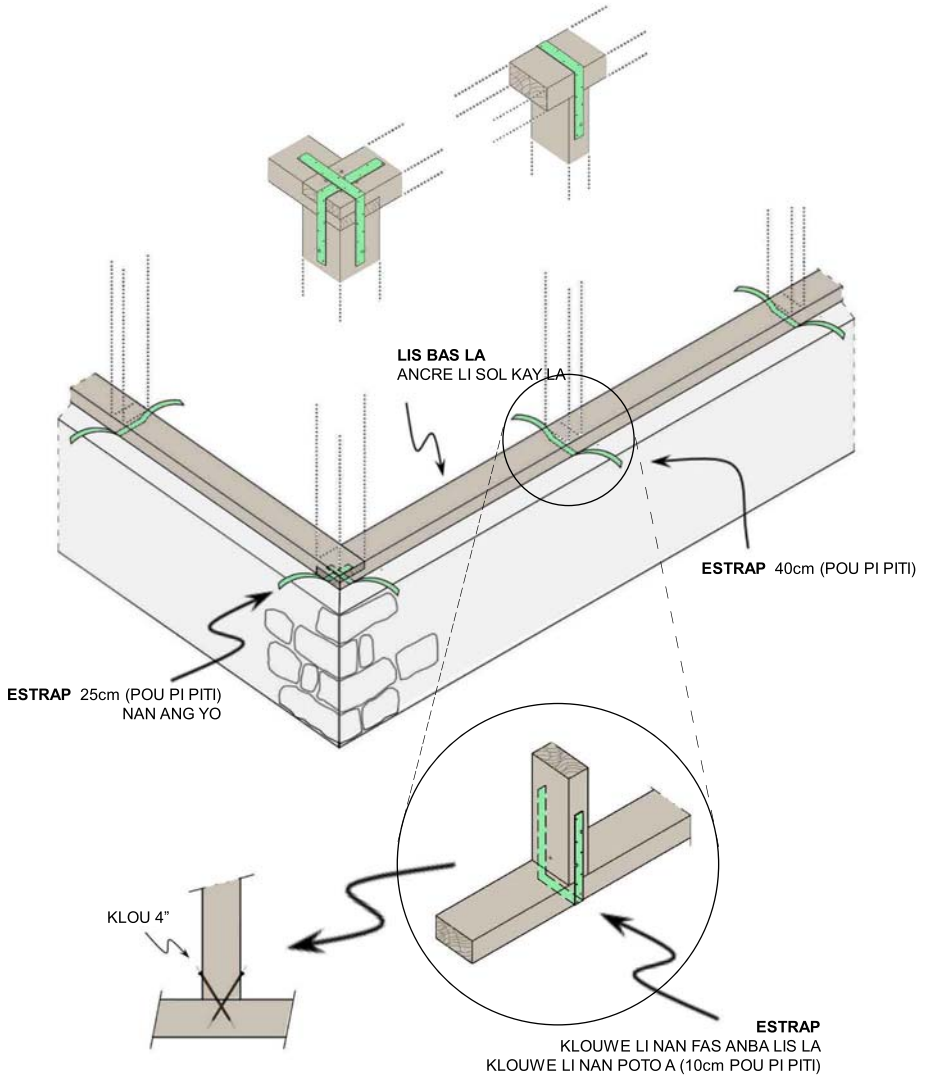

KONEKTE LIS BAS/OT – POTO AK FIL ALIGATI

KIJAN POU NOU DIMANSYONE FIL ALIGATI SELON GWOSE LIS LA BAS LA

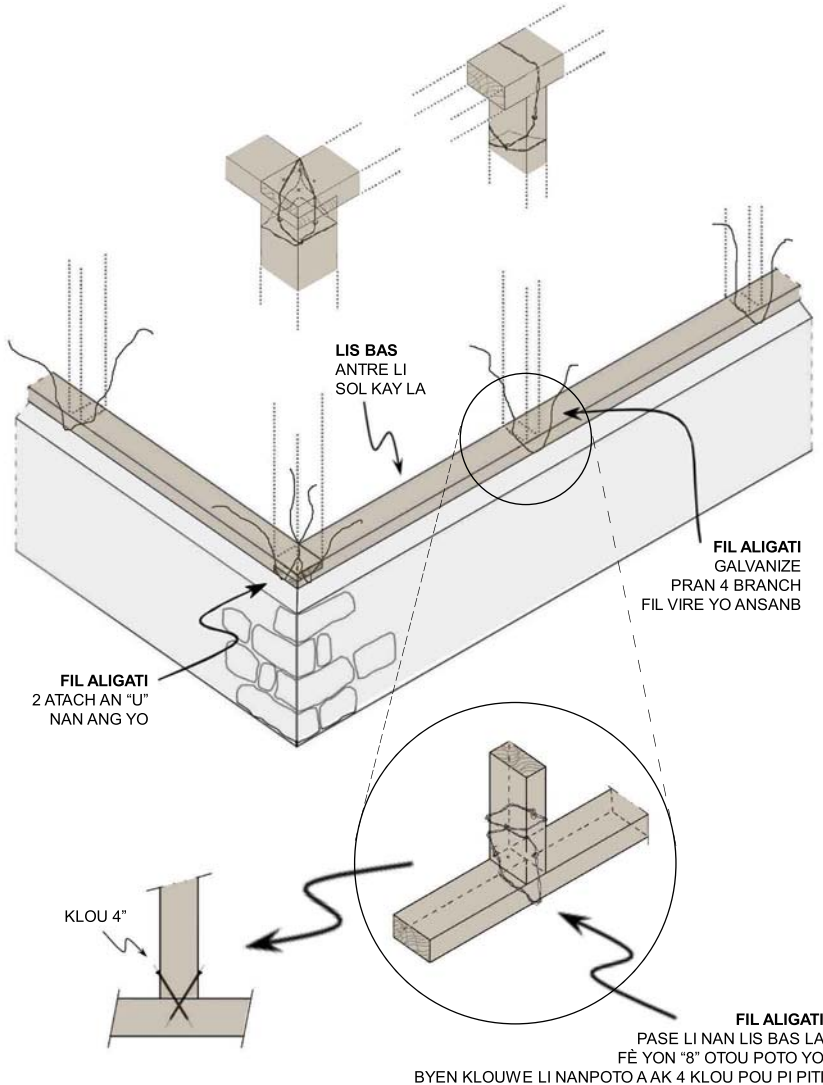

KONEKTE YO PWENT NA PWENT - «MI BWA»

FÈ KLOU AK BWA DI



KLOU AN BWA

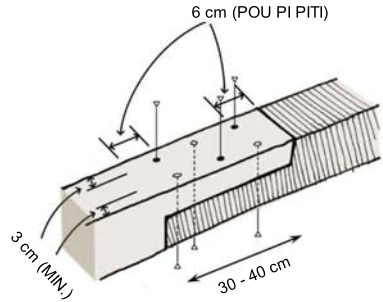

KLOU

KONEKTE ANG - RANJE “TRIYE BWA YO”

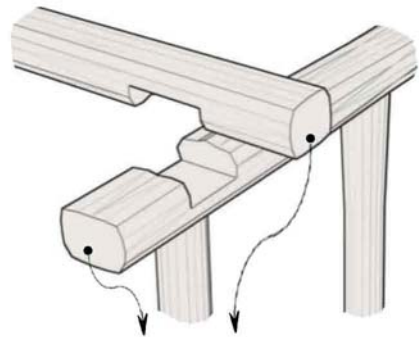
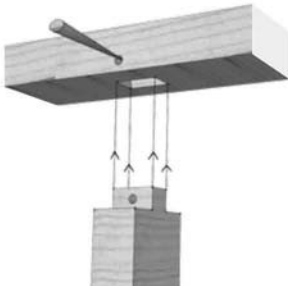
TENON MÔTÈZ AK KLOU AN BWA
LYE POTO YODEPASMAN LIS YO
POU YO KABAB BYEN REZISTE

ESTRIKTI AN BWA - KONTREVANTE ANG YO

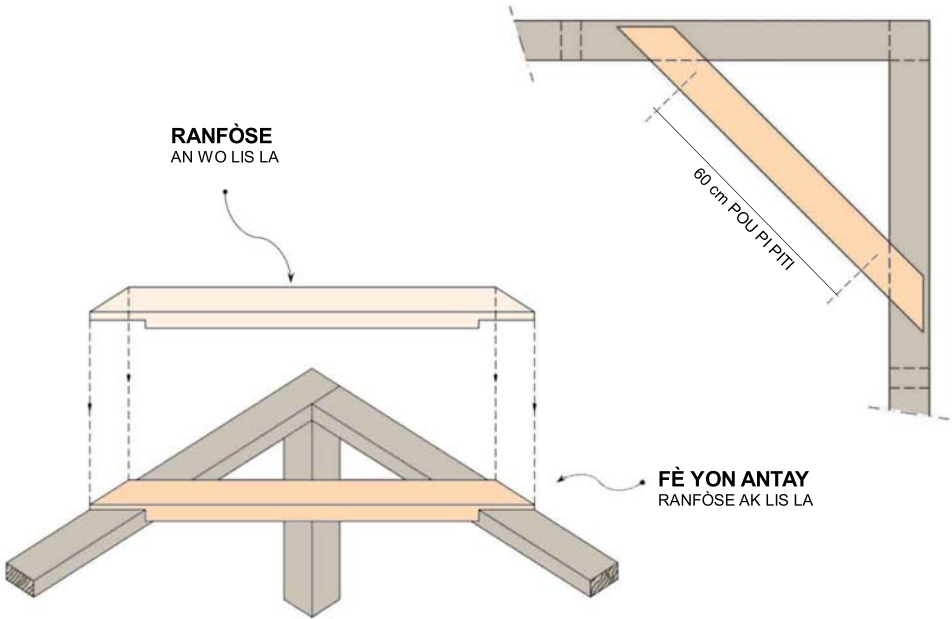

TRÒ KOUT
KLOUWE ANDEDAN YO



BYEN LONG
KLOU LI ANLÈ

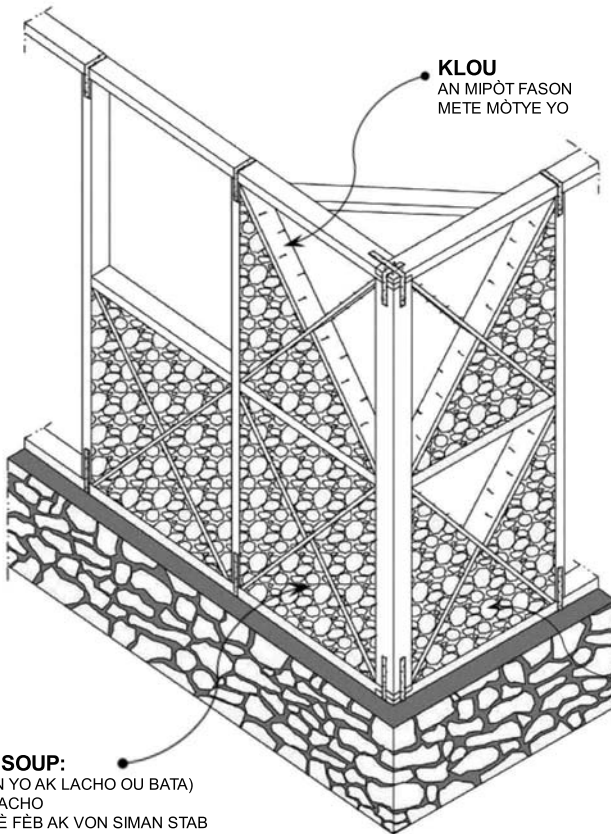

**MÒTYE SOUP:**

- TÈ (JWEN YO AK LACHO OU BATA)
- MÒTYE LACHO
- MÒTYE TÈ FEB AK VON SIMAN STAB

KLOU
AN MIPÒT FASON
METE MÒTYE YO

**WÒCH**

PITI E BYEN KALIBRE
POZE YO A PLA
JWEN FEN
KOFRE LI POU YON TI TANWÒCH



• MÒTYE

- LACHO
- BATA (LACHO + SIMAN)

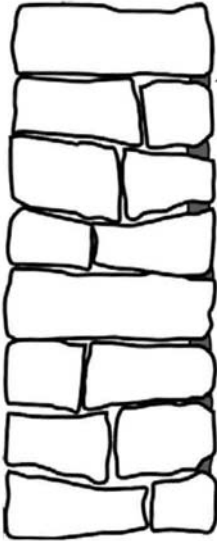

PRINSIP POU NOU KONSTWI

RANPLI / MONTE MI YO - KLISADE

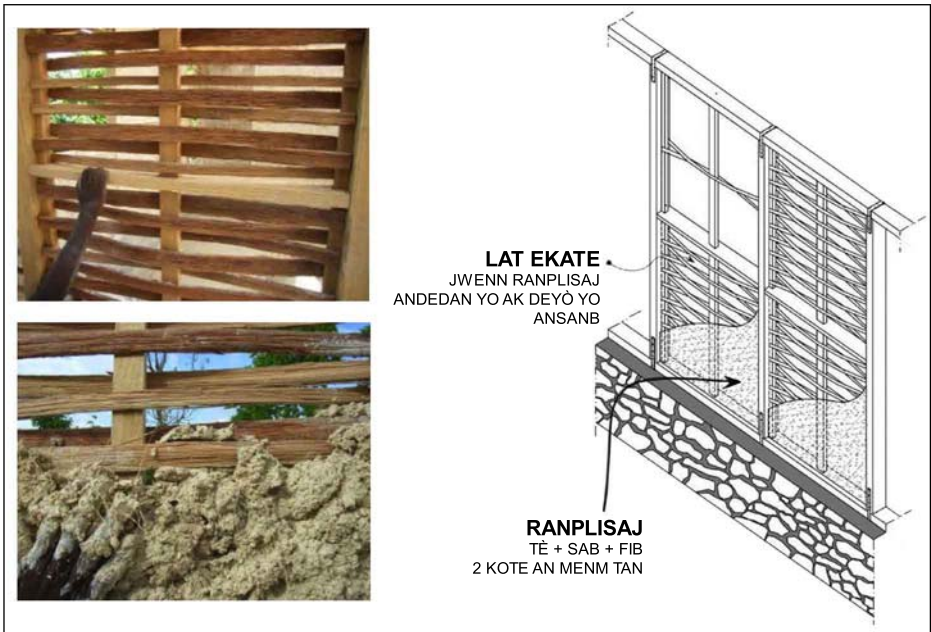
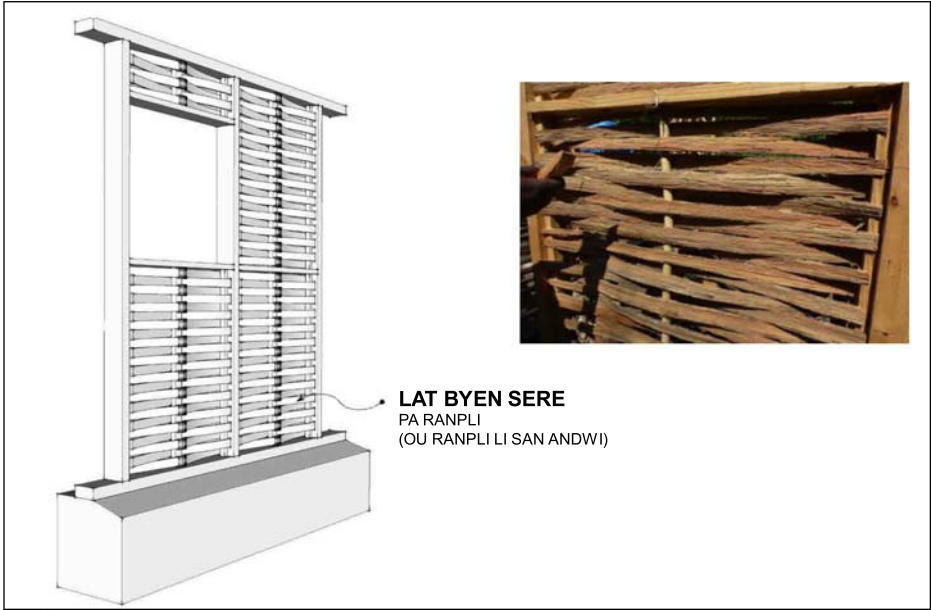

TÈ KAY LA - GALERIA

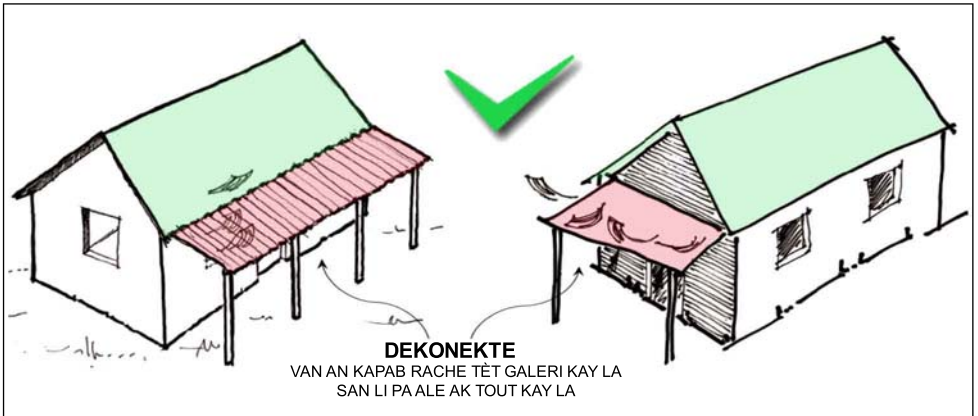
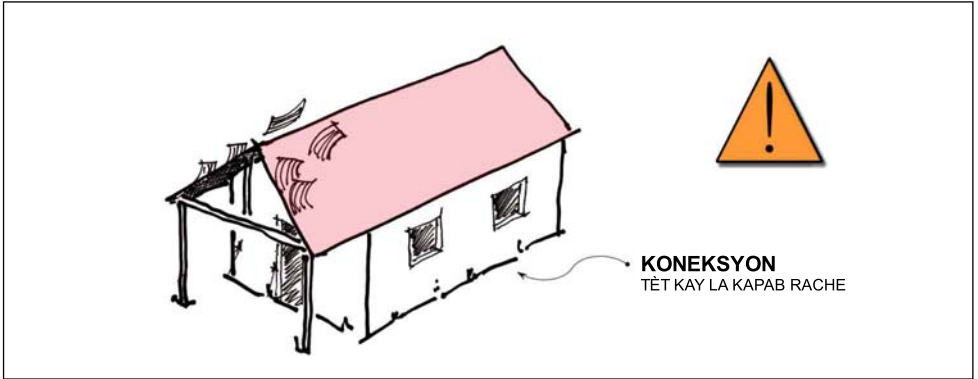

SI TÈT KAY LA PA RACHE

- PLATFÒM (OU LIMITE VAN AN)
- PLANCH NOU TE CHANTOUNE YO (REDWI FÒS VAN AN)
- BÒN ANKRAJ BYEN KONEKTE ESTRIKTI GALERIA

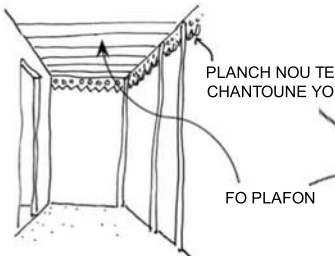

TÈT KAY AK 2 KOTE

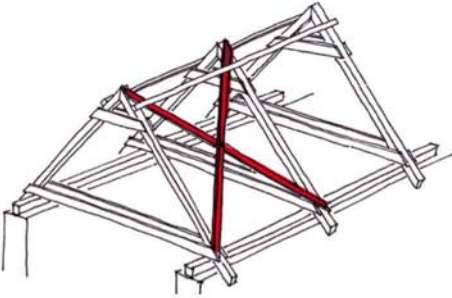

NAN PLAN TÈT KAY LA
LI BAY AKSÈ POU GALATA A

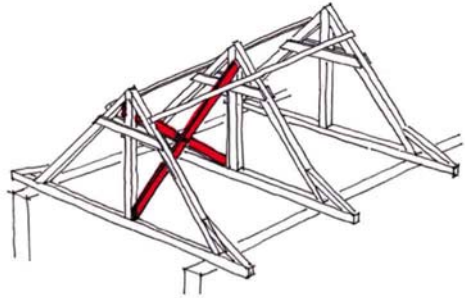

NAN PLAN AN WO A
LI PARÈT DIFISIL POU MONTE GALATA A

TÈT KAY AK 4 KOTE

KONTRENTMAN AK ARETYÈ YO
LI PARÈT DIFISIL POU MONTE GALATA A



CHAPANT - KONEKSYON

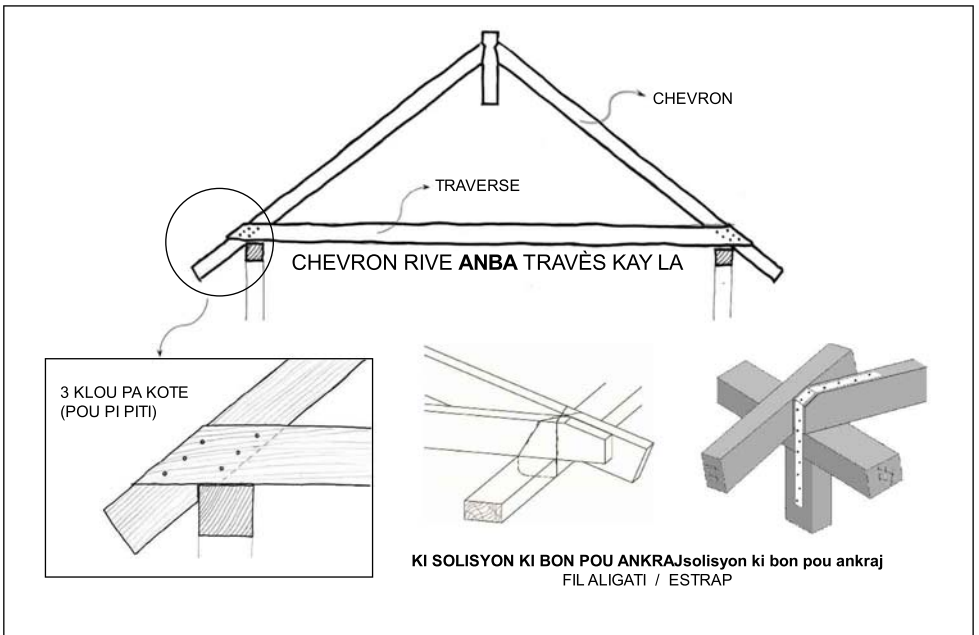
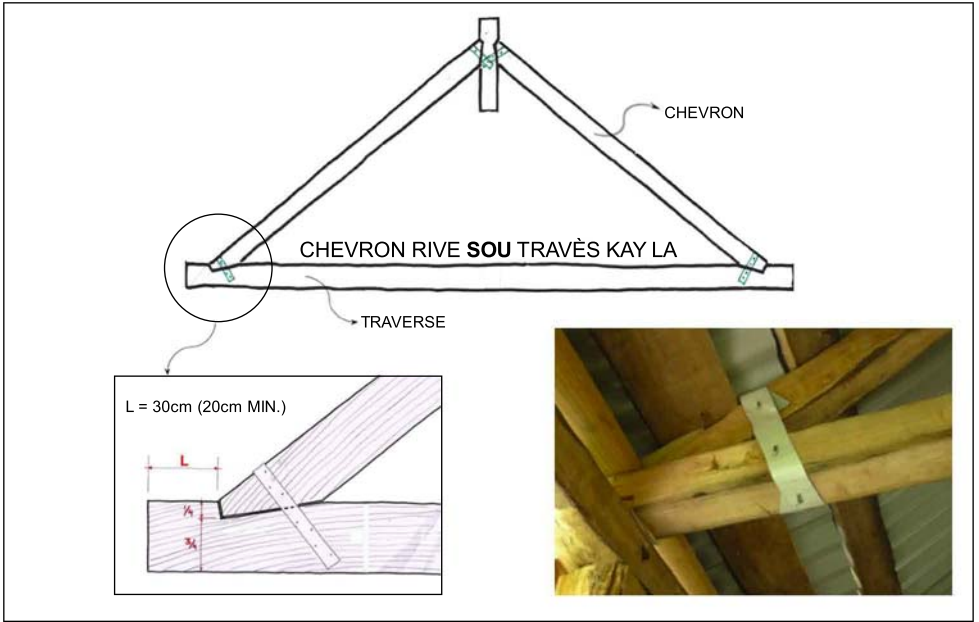

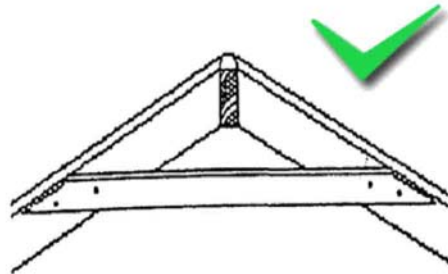
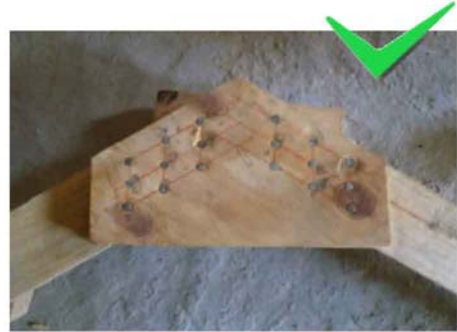
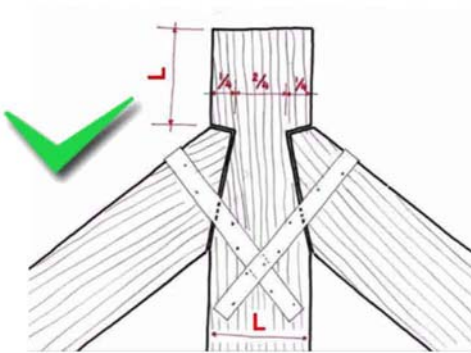
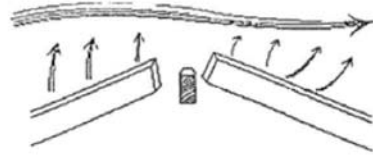
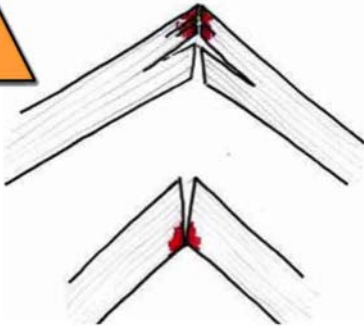

TÈT KAY - AN TÒL

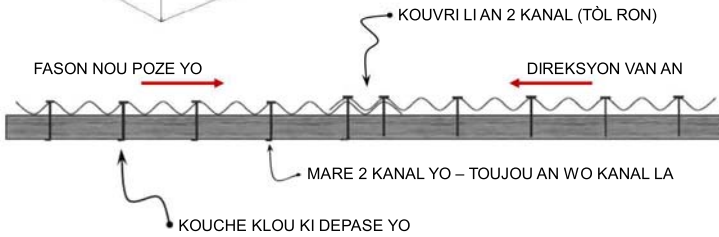
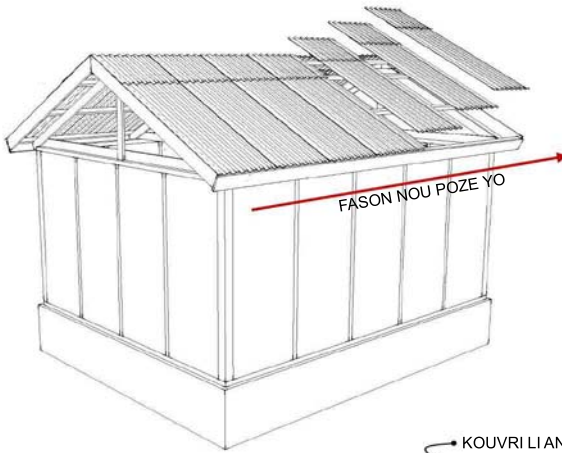

KOUVRI
NAN SANS PANT LA
20 - 30cm (SELON SANS LI)

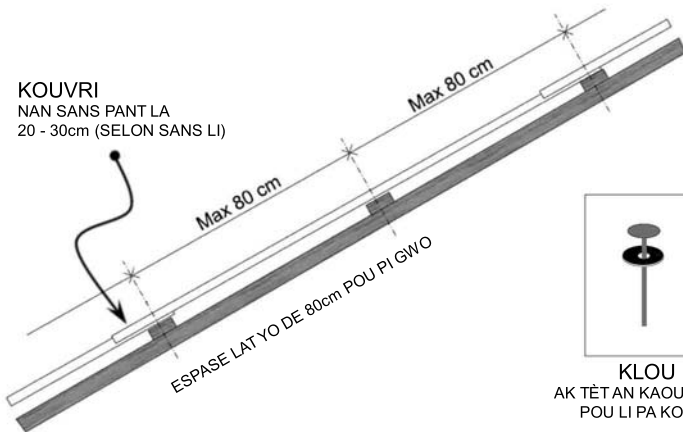

KLOU
AK TÈT AN KAOOUTCHOU
POU LI PA KOULE